



HAGGAI

S U R G I C A L



SURGICAL CATALOGUE



**SURGICAL
INSTRUMENTS
CATALOGUE**

S.No	Descriptions of Items
01	Skalpellklingen, Skalpellgriffe, Messer Scalpel Blades, Scalpel Handles, Knives Hojas de bisturíes, Mangos de bisturíes, Cuchillos Lame per bisturi, Manici per bisturi, Coltelli
02	Scheren , Scissors, Tijeras ,Forbici
03	Pinzetten, Forceps, Pinzas, Pinze
04	Tuch-, Schlauchklemmen, Tupferzangen Towel Clamps, Sponge and Dressing Forceps, Tubing Clamps Pinzas de campo, Pinzas para vendajes y torundas y para tubos Pinze per fissare le compresse, per medicatura e tamponi, e per tubi
05	Klemmen, Forceps, Pinas, Pinze
06	Nahtinstrumente, Suture Instruments, Instrumentos para sutura Strumenti per sutura
07	Wundhaken, Retractors, Separadores , Divaricatori
08	Wundspreizer, Self-Retaining Retractors, Separadores con retenida automática Divaricatori autostatici
09	Sonden, Trokare Probes, Trocars Sondas, Trócares Sonde, Trequarti
10	Magen, Darm, Mastdarm, Stomach, Intestines, Rectum Estómago, Intestino, Recto, Stomaco, Intestino, Retto
11	Galle, Leber, Niere, Blase, Urologie Gall, Liver, Kidney, Bladder, Urology Bilis, Hígado, Riñon, Vejiga, Urología Bile, Fegato, Rene, Vescica, Urologia
12	Gynäkologie, Geburtshilfe, Gynecology, Obstetrics, Ginecología, Obstetricia Ginecologia, Ostetricia
13	Vorbereitung, Dermatologie , Preparation, Dermatology Preparación, Dermatología Preparazione, Dermatalogia
14	Knochenchirurgie, Bone Surgery, Cirugía ósea, Chirurgia ossea
15	Sterilisation, Sterilization, Esterilización, Sterilizzazione

Skalpellklingen, Skalpellgriffe, Messer
Scalpel Blades, Scalpel Handles, Knives
Hojas de bisturías, Mangos de bisturías, Cuchillos
Lame per bisturi, Manici per bisturi, Coltelli



Sterile Skalpellingknigen, Skalpellinggriffe
Sterile Scalpel Blades, Scalpel Handles
Hojas de bisturios estériles, Mangos de bisturios
Lame per bisturi sterili, Manici per bisturi



No. 3
13,0 cm, 5"
HS-1003-03



No. 3
13,0 cm, 5"
HS-1003-04



No. 3L
21,0 cm, 8 1/4"
HS-1003-05



No. 7
16,5 cm, 6 1/2"
HS-1007-06



No. 7K
13,0 cm, 5"
HS-1007-07

Sterile Skalpellklingen, Skalpellgriffe
Sterile Scalpel Blades, Scalpel Handles
Hojas de bisturíes estériles, Mangos de bisturíes
Lame per bisturi sterili, Manici per bisturi



No. 4
13,5 cm, 5³/₈"
HS-1004-04



No. 4L
21,0 cm, 8³/₈"
HS-1004-04L



No. 8
13,5 cm, 5³/₈"
HS-1004-08



No. 9
14,5 cm, 5³/₄"
HS-1004-09



Fig. 10
HS-1005-10



Fig. 11
HS-1005-11



Fig. 11s
HS-1005-11S



Fig. 12
HS-1005-12



Fig. 12d
HS-1005-12D



Fig. 13
HS-1005-13



Fig. 15
HS-1005-15



Fig. 15c
HS-1005-15C



Fig. 18
HS-1005-18



Fig. 19
HS-1005-19



Fig. 20
HS-1005-20



Fig. 21
HS-1005-21



Fig. 22
HS-1005-22



Fig. 23
HS-1005-23



Fig. 24
HS-1005-24



Fig. 25
HS-1005-25



Fig. 1 HS-1006-01
Fig. 2 HS-1006-02
Fig. 3 HS-1006-03



OPERATION
17,0 cm, 6¾"

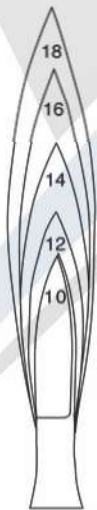

Fig. 10 HS-1006-10
Fig. 12 HS-1006-12
Fig. 14 HS-1006-14
Fig. 16 HS-1006-16
Fig. 18 HS-1006-18



COLLIN
16,0 cm, 6¼"



Fig. 4 HS-1006-04
Fig. 5 HS-1006-05
Fig. 6 HS-1006-06

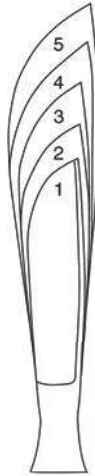

Fig. 1 HS-1007-01
Fig. 2 HS-1007-02
Fig. 3 HS-1007-03
Fig. 4 HS-1007-04
Fig. 5 HS-1007-05



Fig. 1 HS-1008-01
Fig. 2 HS-1008-02
Fig. 3 HS-1008-03
Fig. 4 HS-1008-04
Fig. 5 HS-1008-05



Fig. 15 HS-1008-15



Fig. 6 HS-1007-06
Fig. 7 HS-1007-07
Fig. 8 HS-1007-08
Fig. 9 HS-1007-09
Fig. 10 HS-1007-10



Fig. 6 HS-1008-06
Fig. 7 HS-1008-07
Fig. 8 HS-1008-08
Fig. 9 HS-1008-09

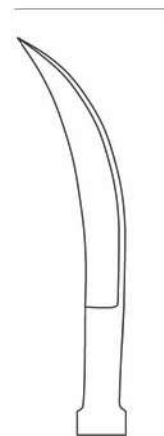

Fig. 16 HS-1008-16

DISSECTING
17,0 cm, 6¾"

DIEFENBACH
16,0 cm, 6¼"



COLLIN

a	
13,0 cm, 5"	HS-1008-13
16,0 cm, 6 ¹ / ₄ "	HS-1008-16
19,0 cm, 7 ¹ / ₂ "	HS-1008-19
22,0 cm, 8 ⁵ / ₈ "	HS-1008-22
28,0 cm, 11"	HS-1008-28

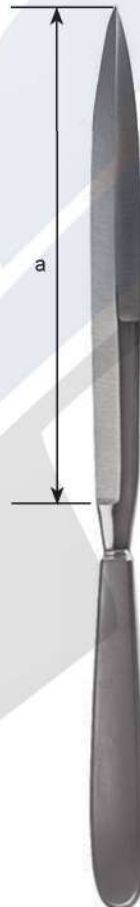

CATLIN

A	A
16,0 cm, 6 ¹ / ₄ "	HS-1009-16
19,0 cm, 7 ¹ / ₂ "	HS-1009-19
22,0 cm, 8 ⁵ / ₈ "	HS-1009-22

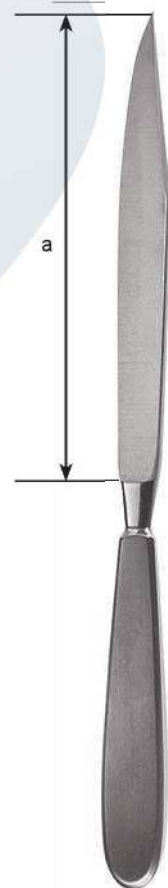

LISTON

17,0 cm, 6 ³ / ₄ "	HS-1009-17
20,0 cm, 8"	HS-1009-20
22,0 cm, 8 ⁵ / ₈ "	HS-1009-22

Amputationsmesser, Messer für Autopsie
 Amputation Knives, Post Mortem Knives
 Cuchillos para amputación, Cuchillos para autopsia
 Coltelli per amputazione, Coltelli per autopsia

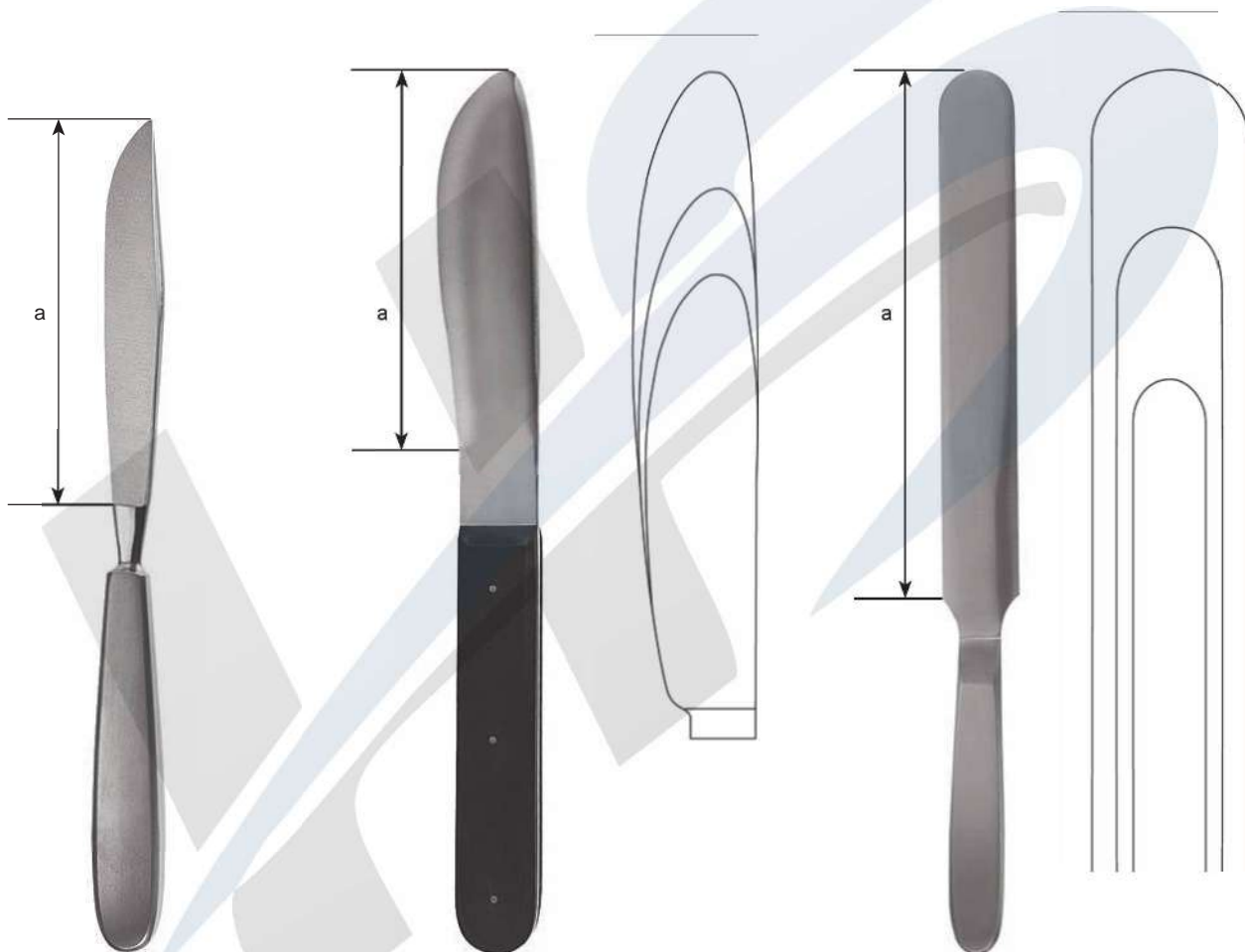

LANGENBECK
 HS-1010-16

WALB	
A	A
11,0 cm, 4 1/2"	HS-1010-11
14,0 cm, 5 1/2"	HS-1010-14
17,0 cm, 6 3/4"	HS-1010-17

VIRCHOW

16,0 cm, 6 1/4"	HS-1011-16
20,0 cm, 8"	HS-1011-20
24,0 cm, 9 1/2"	HS-1011-24

Amputationsmesser, Dermatome
Amputation Knives, Dermatomes
Cuchillos para amputación, Dermátomos
Coltelli per amputazione, Dermatomi



LANGENBECK
18,0 cm, 7"
HS-1011-55



mit Schaber
with raspatory
con periostótomo
con raschiatoio

CARTILAGE
17,5 cm, 6⁵/₈"
HS-1011-65



Haut-Spannplatten
Skin straightening plate
Placa para extender la piel
Placca per stendere la pelle

HS-1011-30

Resektionsmesser
Resection Knives
Cuchillos para resección
Coltelli per resezione

HS-1012-19
Ersatzklinge
Spare blade
Hoja de repuesto
Lama di ricambio

HS-1012-30
Ersatzklinge
Spare blade
Hoja de repuesto
Lama di ricambio

HS-1012-35
Ersatzklinge
Spare blade
Hoja de repuesto
Lama di ricambio

HS-1012-30
Ersatzklinge
Spare blade
Hoja de repuesto
Lama di ricambio



SILVER
19 cm, 7 1/2"
HS-1013-19

BRAITHWAITE
30,0 cm, 12"
HS-1013-30

HUMBY
35,0 cm, 14"
HS-1013-35

SCHINK
30,0 cm, 12"
HS-1013-30

Scheren
Scissors
Tijeras
Forbici



Chirurgische Scheren
Surgical Scissors
Tijeras para cirugía
Forbici per chirurgia



STANDARD	
10,5 cm, 4 ¹ / ₄ "	HS-1014-10
11,5 cm, 4 ¹ / ₂ "	HS-1014-11
13,0 cm, 5"	HS-1014-13
14,5 cm, 5 ³ / ₄ "	HS-1014-14
15,5 cm, 6"	HS-1014-15
16,5 cm, 6 ¹ / ₂ "	HS-1014-16
17,5 cm, 6 ⁵ / ₈ "	HS-1014-17
18,5 cm, 7 ¹ / ₄ "	HS-1014-18
20,0 cm, 8"	HS-1014-20



STANDARD	
10,5 cm, 4 ¹ / ₄ "	HS-1015-10
11,5 cm, 4 ¹ / ₂ "	HS-1015-11
13,0 cm, 5"	HS-1015-13
14,5 cm, 5 ³ / ₄ "	HS-1015-14
15,5 cm, 6"	HS-1015-15
16,5 cm, 6 ¹ / ₂ "	HS-1015-16
17,5 cm, 6 ⁵ / ₈ "	HS-1015-17
18,5 cm, 7 ¹ / ₄ "	HS-1015-18
20,0 cm, 8"	HS-1015-20



STANDARD	
10,5 cm, 4 ¹ / ₄ "	HS-1016-10
11,5 cm, 4 ¹ / ₂ "	HS-1016-11
13,0 cm, 5"	HS-1016-13
14,5 cm, 5 ³ / ₄ "	HS-1016-14
15,5 cm, 6"	HS-1016-15
16,5 cm, 6 ¹ / ₂ "	HS-1016-16
17,5 cm, 6 ⁵ / ₈ "	HS-1016-17
18,5 cm, 7 ¹ / ₄ "	HS-1016-18
20,0 cm, 8"	HS-1016-20



STANDARD	
10,5 cm, 4 ¹ / ₄ "	HS-1017-10
11,5 cm, 4 ¹ / ₂ "	HS-1017-11
13,0 cm, 5"	HS-1017-13
14,5 cm, 5 ³ / ₄ "	HS-1017-14
15,5 cm, 6"	HS-1017-15
16,5 cm, 6 ¹ / ₂ "	HS-1017-16
17,5 cm, 6 ⁵ / ₈ "	HS-1017-17
18,5 cm, 7 ¹ / ₄ "	HS-1017-18
20,0 cm, 8"	HS-1017-20

Chirurgische Scheren, Präparierscheren
 Surgical Scissors, Dissecting Scissors
 Tijeras para cirugía, Tijeras de disección
 Forbici per chirurgia, Forbici per dissezione



STANDARD		
10,5 cm, 4 ¹ / ₄ "	HS-1018-10	
11,5 cm, 4 ¹ / ₂ "	HS-1018-11	
13,0 cm, 5"	HS-1018-13	
14,5 cm, 5 ³ / ₄ "	HS-1018-14	
15,5 cm, 6"	HS-1018-15	
16,5 cm, 6 ¹ / ₂ "	HS-1018-16	
17,5 cm, 6 ⁵ / ₈ "	HS-1018-17	
18,5 cm, 7 ¹ / ₄ "	HS-1018-18	
20,0 cm, 8"	HS-1018-20	

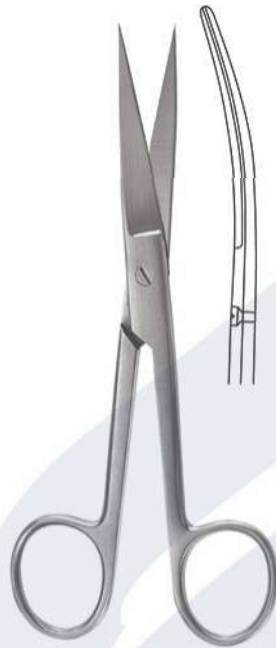

STANDARD		
10,5 cm, 4 ¹ / ₄ "	HS-1020-10	
11,5 cm, 4 ¹ / ₂ "	HS-1020-11	
13,0 cm, 5"	HS-1020-13	
14,5 cm, 5 ³ / ₄ "	HS-1020-14	
15,5 cm, 6"	HS-1020-15	
16,5 cm, 6 ¹ / ₂ "	HS-1020-16	
17,5 cm, 6 ⁵ / ₈ "	HS-1020-17	
18,5 cm, 7 ¹ / ₄ "	HS-1020-18	
20,0 cm, 8"	HS-1020-20	



DEAVER		
12,0 cm, 4 ³ / ₄ "	HS-1021-12	
13,0 cm, 5"	HS-1021-13	
14,5 cm, 5 ³ / ₄ "	HS-1021-14	



DEAVER		
12,0 cm, 4 ³ / ₄ "	HS-1022-12	
13,0 cm, 5"	HS-1022-13	
14,5 cm, 5 ³ / ₄ "	HS-1022-14	

Präparierscheren
Dissecting Scissors
Tijeras de disección
Forbici per dissezione



DEAVER	
12,0 cm, 4 ³ / ₄ "	HS-1023-12
13,0 cm, 5"	HS-1023-13
14,5 cm, 5 ³ / ₄ "	HS-1023-14



DEAVER	
12,0 cm, 4 ³ / ₄ "	HS-1024-12
13,0 cm, 5"	HS-1024-13
14,5 cm, 5 ³ / ₄ "	HS-1024-14



DEAVER	
12,0 cm, 4 ³ / ₄ "	HS-1025-12
13,0 cm, 5"	HS-1025-13
14,5 cm, 5 ³ / ₄ "	HS-1025-14



DEAVER	
12,0 cm, 4 ³ / ₄ "	HS-1026-12
13,0 cm, 5"	HS-1026-13
14,5 cm, 5 ³ / ₄ "	HS-1026-14

Präparierscheren
Dissecting Scissors
Tijeras de disección
Forbici per dissezione



GRAZIL
13,0 cm, 5" HS-1027-13
14,5 cm, 5¾" HS-1027-14



GRAZIL
13,0 cm, 5" HS-1028-13
14,5 cm, 5¾" HS-1028-14



GRAZIL
13,0 cm, 5" HS-1029-13
14,5 cm, 5¾" HS-1029-14



GRAZIL
13,0 cm, 5" HS-1030-13
14,5 cm, 5¾" HS-1030-14

Präparierscheren
Dissecting Scissors
Tijeras de disección
Forbici per dissezione



GRAZIL
13,0 cm, 5" HS-1031-13
14,5 cm, 5³/₄" HS-1031-14



GRAZIL
13,0 cm, 5" HS-1032-13
14,5 cm, 5³/₄" HS-1032-14

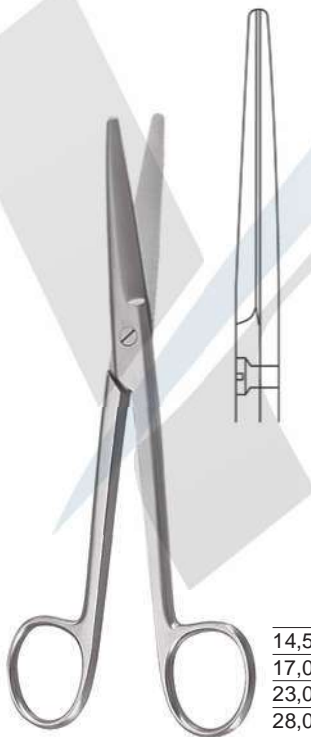

MAYO
14,5 cm, 5³/₄" HS-1033-14
17,0 cm, 6³/₄" HS-1033-17
23,0 cm, 9" HS-1033-23
28,0 cm, 11" HS-1033-28

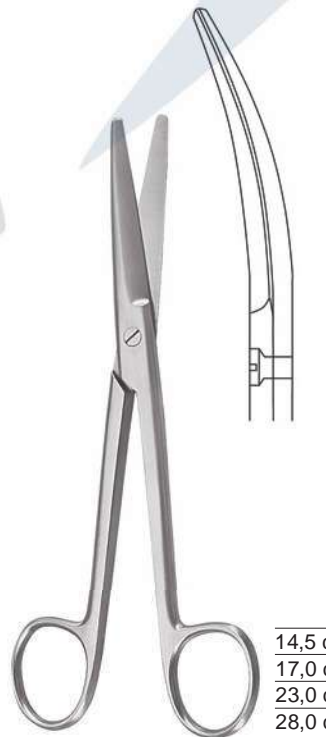

MAYO
14,5 cm, 5³/₄" HS-1034-14
17,0 cm, 6³/₄" HS-1034-17
23,0 cm, 9" HS-1034-23
28,0 cm, 11" HS-1034-28

Präparierscheren
Dissecting Scissors
Tijeras de disección
Forbici per dissezione

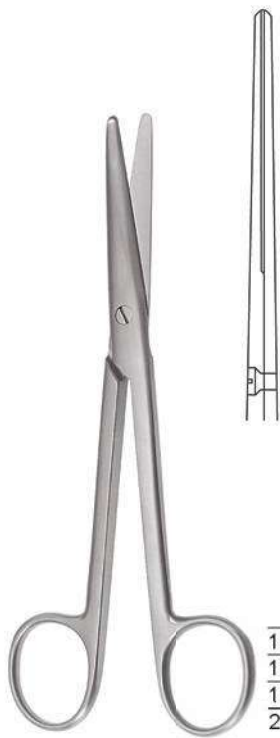

MAYO-STILE

15,0 cm, 6"	HS-1035-15
17,0 cm, 6 ³ / ₄ "	HS-1035-17
19,5 cm, 7 ³ / ₄ "	HS-1035-19
21,0 cm, 8 ¹ / ₄ "	HS-1035-21



MAYO-STILE

15,0 cm, 6"	HS-1036-15
17,0 cm, 6 ³ / ₄ "	HS-1036-17
19,5 cm, 7 ³ / ₄ "	HS-1036-19
21,0 cm, 8 ¹ / ₄ "	HS-1036-21



MAYO-NOBLE

17,0 cm, 6³/₄"



HS-1037-17



HS-1038-17



FOMON

13,5 cm, 5³/₈"

HS-1039-13



HAGGAI

S U R G I C A L

Präparierscheren
Dissecting Scissors
Tijeras de disección
Forbici per dissezione



BABY-METZENBAUM
11,5 cm, 4 1/2"



HS-1040-11



HS-1041-11



METZENBAUM
14,5 cm, 5 3/4"



HS-1042-14

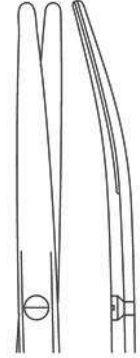

HS-1043-14



METZENBAUM
14,5 cm, 5 3/4"



HS-1044-14



METZENBAUM
14,5 cm, 5 3/4"



HS-1045-14



METZENBAUM

18,0 cm, 7"	HS-1046-18
20,0 cm, 8"	HS-1046-20
23,0 cm, 9"	HS-1046-23
25,0 cm, 10"	HS-1046-25
28,0 cm, 11"	HS-1046-28
30,0 cm, 12"	HS-1046-30



METZENBAUM

18,0 cm, 7"	HS-1047-18
20,0 cm, 8"	HS-1047-20
23,0 cm, 9"	HS-1047-23
25,0 cm, 10"	HS-1047-25
28,0 cm, 11"	HS-1047-28
30,0 cm, 12"	HS-1047-30



METZENBAUM

18,0 cm, 7"	HS-1048-18
20,0 cm, 8"	HS-1048-20
23,0 cm, 9"	HS-1048-23
25,0 cm, 10"	HS-1048-25
28,0 cm, 11"	HS-1048-28
30,0 cm, 12"	HS-1048-30



METZENBAUM

18,0 cm, 7"	HS-1049-18
20,0 cm, 8"	HS-1049-20
23,0 cm, 9"	HS-1049-23
25,0 cm, 10"	HS-1049-25
28,0 cm, 11"	HS-1049-28
30,0 cm, 12"	HS-1049-30



S U R G I C A L



METZENBAUM

18,0 cm, 7"	HS-1050-18
20,0 cm, 8"	HS-1050-20
23,0 cm, 9"	HS-1050-23
25,0 cm, 10"	HS-1050-25
28,0 cm, 11"	HS-1050-28
30,0 cm, 12"	HS-1050-30



METZENBAUM

18,0 cm, 7"	HS-1051-18
20,0 cm, 8"	HS-1051-20
23,0 cm, 9"	HS-1051-23
25,0 cm, 10"	HS-1051-25
28,0 cm, 11"	HS-1051-28
30,0 cm, 12"	HS-1051-30



METZENBAUM-FINO

14,5 cm, 5³/₄"



HS-1052-14



HS-1053-14



METZENBAUM-FINO

18,0 cm, 7"	HS-1054-18
20,0 cm, 8"	HS-1054-20
23,0 cm, 9"	HS-1054-23
25,0 cm, 10"	HS-1054-25
28,0 cm, 11"	HS-1054-28
30,0 cm, 12"	HS-1054-30

S U R G I C A L

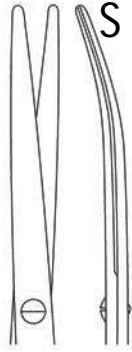

18,0 cm, 7"	HS-1057-18
20,0 cm, 8"	HS-1057-20
23,0 cm, 9"	HS-1057-23
25,0 cm, 10"	HS-1057-25
28,0 cm, 11"	HS-1057-28
30,0 cm, 12"	HS-1057-30

METZENBAUM-FINO



HS-1055-14



HS-1056-14

METZENBAUM-FINO
14,5 cm, 5³/₄"

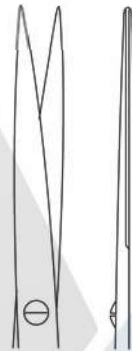

18,0 cm, 7"	HS-1058-18
20,0 cm, 8"	HS-1058-20
23,0 cm, 9"	HS-1058-23
25,0 cm, 10"	HS-1058-25
28,0 cm, 11"	HS-1058-28
30,0 cm, 12"	HS-1058-30

METZENBAUM-FINO



18,0 cm, 7"	HS-1059-18
20,0 cm, 8"	HS-1059-20
23,0 cm, 9"	HS-1059-23
25,0 cm, 10"	HS-1059-25
28,0 cm, 11"	HS-1059-28
30,0 cm, 12"	HS-1059-30

METZENBAUM-FINO

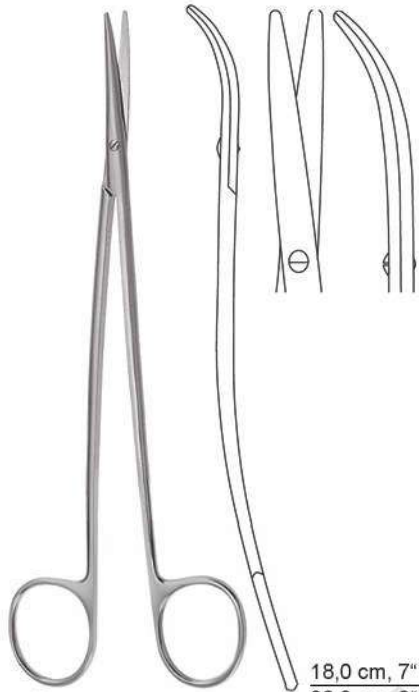

METZENBAUM-FINO S

18,0 cm, 7"	HS-1060-18
20,0 cm, 8"	HS-1060-20
23,0 cm, 9"	HS-1060-23

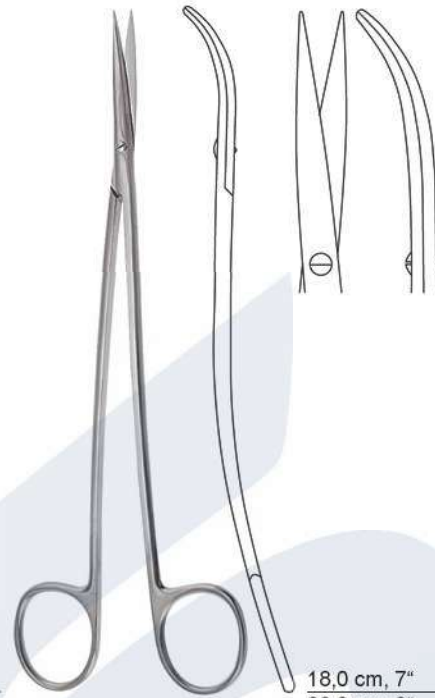

METZENBAUM-FINOS

18,0 cm, 7"	HS-1061-18
20,0 cm, 8"	HS-1061-20
23,0 cm, 9"	HS-1061-23



METZENBAUM-LAHEY

14,0 cm, 5 1/2"	HS-1062-14
-----------------	-------------------



TOENNIS-ADSON

17,0 cm, 6 3/4"	HS-1063-17
-----------------	-------------------



BABY-LEXER
10,0 cm, 4"



HS-1064-10



HS-1065-10



LEXER

16,0 cm, 6¹/₄"
21,0 cm, 8¹/₄"

HS-1066-16
HS-1066-21



LEXER

16,0 cm, 6¹/₄"
21,0 cm, 8¹/₄"

HS-1069-16
HS-1069-21



MIXTER

17,0 cm, 6³/₄"



HS-1067-17

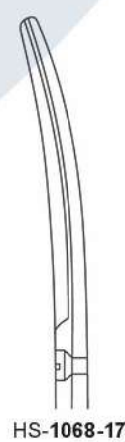

HS-1068-17



HAGGAI

S U R G I C A L

Präparierscheren, feine chirurgische Scheren
Dissecting Scissors, fine surgical scissors
Tijeras de disección, tijeras finas para cirugía
Forbici per dissezione, forbici fine per chirurgia



KILNER (RAGNELL)

12,0 cm, 4 ³ / ₄ "	HS-1070-12
15,0 cm, 6"	HS-1070-15
18,0 cm, 7"	HS-1070-18
20,0 cm, 8"	HS-1070-20



KILNER (RAGNELL)

12,0 cm, 4 ³ / ₄ "	HS-1071-12
15,0 cm, 6"	HS-1071-15
18,0 cm, 7"	HS-1071-18
20,0 cm, 8"	HS-1071-20



REYNOLDS

15,0 cm, 6"	HS-1072-15
18,0 cm, 7"	HS-1072-18



REYNOLDS

15,0 cm, 6"	HS-1073-15
18,0 cm, 7"	HS-1073-18
20,0 cm, 8"	HS-1073-20
23,0 cm, 9"	HS-1073-23
25,0 cm, 10"	HS-1073-25



THOREK



19,0 cm, 7 1/2"
HS-1074-19



25,0 cm, 10"
HS-1075-25



15,0 cm, 6"



HS-1076-15



HS-1077-15

Nerv-Präparierscheren
Nerve dissecting scissors
Tijeras para nervios
Forbici per dissezione di nervi



SANVENERO
14,0 cm, 5 1/2"



HS-1078-14



HS-1079-14



JOSEPH
14,0 cm, 5 1/2"



HS-1080-14



HS-1081-14





HAGGAI

S U R G I C A L

Feine chirurgische Scheren
Fine surgical scissors
Tijeras finas para cirugía
Forbici fine per chirurgia

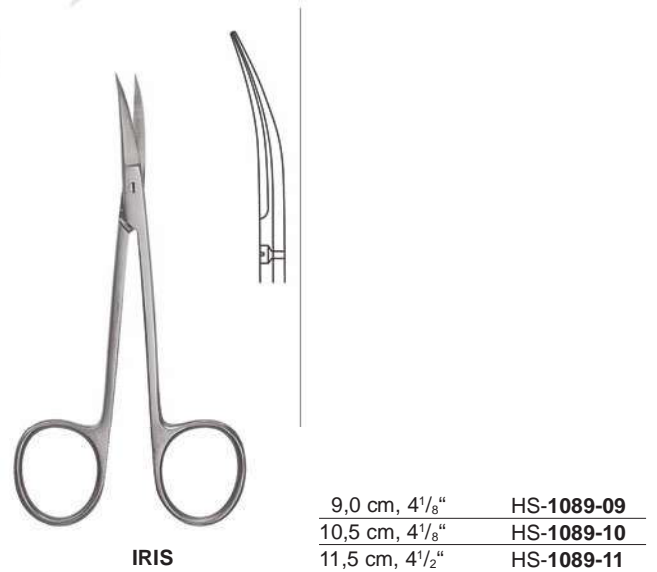
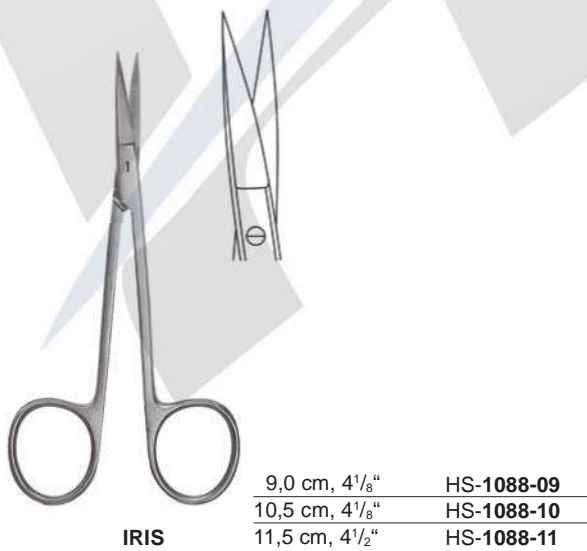
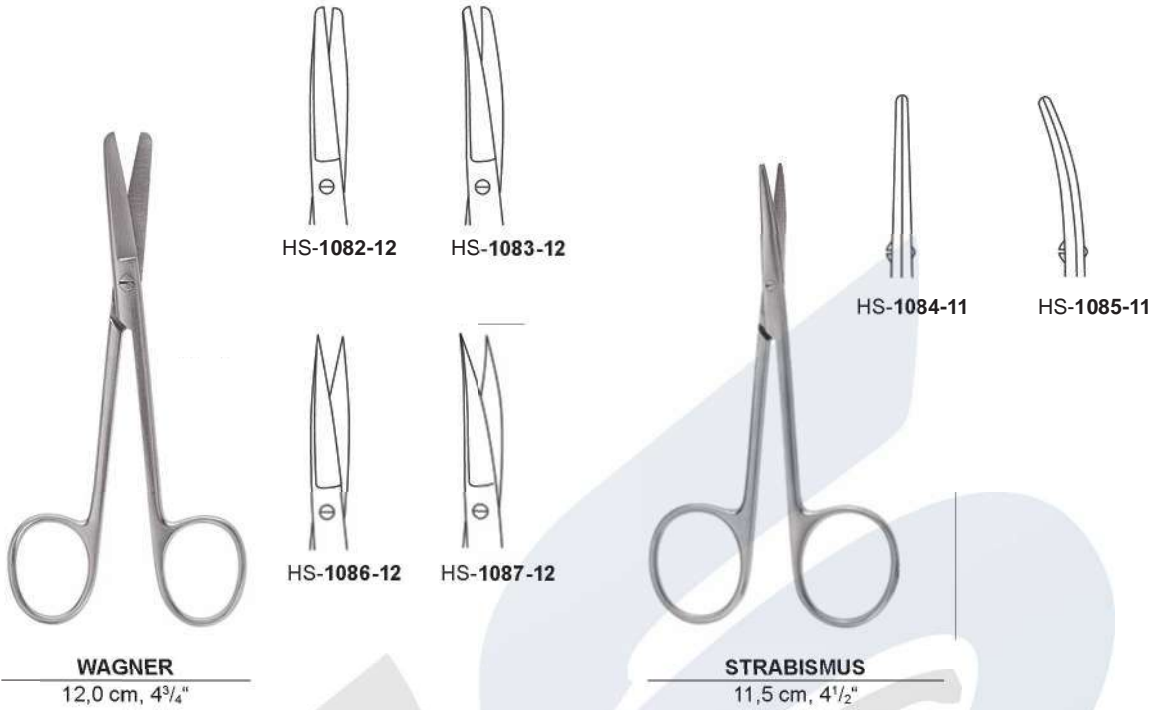



HAGGAI

S U R G I C A L

Feine chirurgische Scheren
Fine surgical scissors
Tijeras finas para cirugía
Forbici fine per chirurgia



IRIS

10,5 cm, 4¹/₈" HS-1090-10
11,5 cm, 4¹/₂" HS-1090-11



IRIS

10,5 cm, 4¹/₈" HS-1091-10
11,5 cm, 4¹/₂" HS-1091-11



11,5 cm, 4¹/₂"
HS-1092-11



11,5 cm, 4¹/₂"
HS-1093-11



HAGGAI

S U R G I C A L

Feine chirurgische Scheren
Fine surgical scissors
Tijeras finas para cirugía
Forbici fine per chirurgia

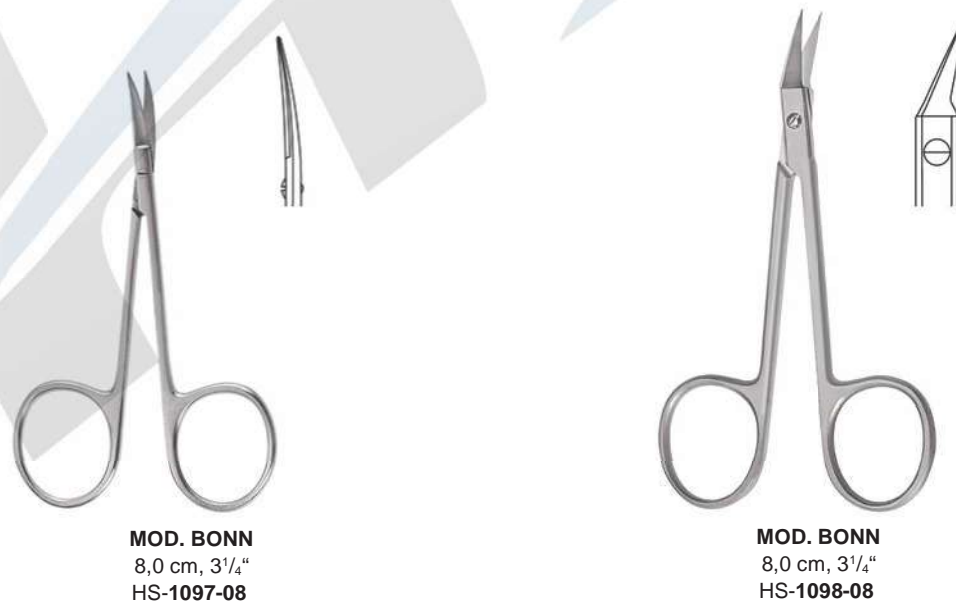



BROPHY (SULLIVAN)
 14,0 cm, 5 1/2"
 HS-1099-14



BROPHY (SULLIVAN)
 14,0 cm, 5 1/2"
 HS-1100-14



10,5 cm, 4 1/8"	HS-1101-10	HS-1102-10	HS-1103-10	HS-1104-10
11,5 cm, 4 1/2"	HS-1101-11	HS-1102-11	HS-1103-11	HS-1104-11



LANDOLT
 12,5 cm, 5"



STEVENS



Inzisionsscheren
Incision scissors
Tijeras para incisión
Forbici vascolare e per fistole

13,0 cm, 5" **HS-1108-13**
14,5 cm, 5¾" **HS-1108-14**



Inzisionsscheren
Incision scissors
Tijeras para incisión
Forbici vascolare e per fistole

HS-1109-16
16,5 cm, 36½"



RICHTER
14,5 cm, 5¾"
HS-1110-14



LAWSON TAIT
12,5 cm, 5"
HS-1111-12



FERGUSSON
16,5 cm, 6¼" **HS-1112-16**
18,0 cm, 7" **HS-1112-18**

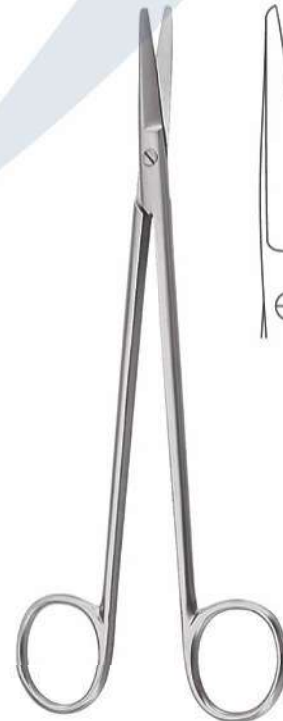

TOENNIS
18,0 cm, 7"
HS-1113-18

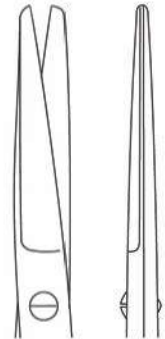



HAGGAI

S U R G I C A L

Chirurgische Scheren, Ligaturscheren
Surgical scissors, Ligature Scissors
Tijeras para cirugía, Tijeras para ligaduras
Forbici per chirurgia, Forbici per legature



TOENNIS
18,0 cm, 7"
HS-1114-18



HALLE
19,0 cm, 7½"
HS-1115-19

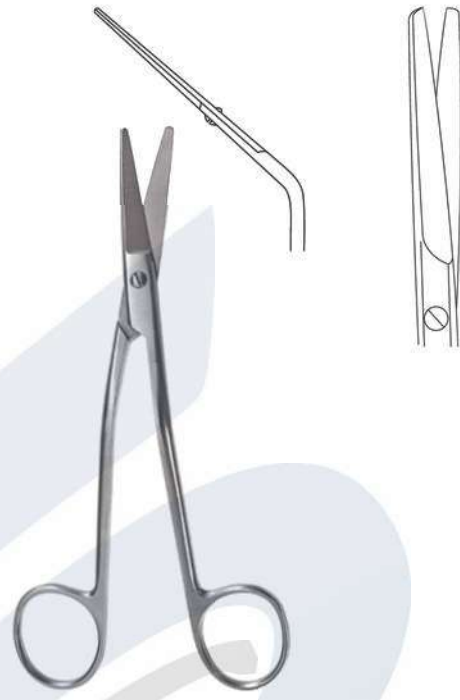

FOMON
15,0 cm, 6"



SPENCER
9,0 cm, 4⅛" HS-1117-09
10,5 cm, 4⅛" HS-1117-10
13,0 cm, 5" HS-1117-13



LITTAUER
11,5 cm, 4¼" HS-1118-11
14,0 cm, 5½" HS-1118-14



BUCK

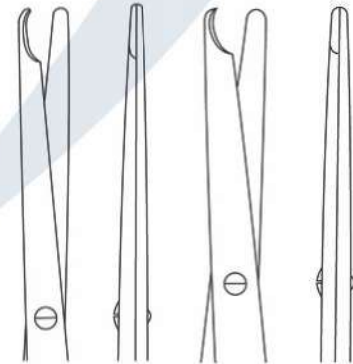

14,5 cm, 5¾"
HS-1119-14

18,0 cm, 7"
HS-1120-18



HAGGAI

S U R G I C A L

Ligaturscheren, Neurochirurgische Scheren
Ligature Scissors, Neurosurgical Scissors
Tijeras para ligaduras, Tijeras para Neurocirugía
Forbici per legature, Forbici per Neurochirurgia

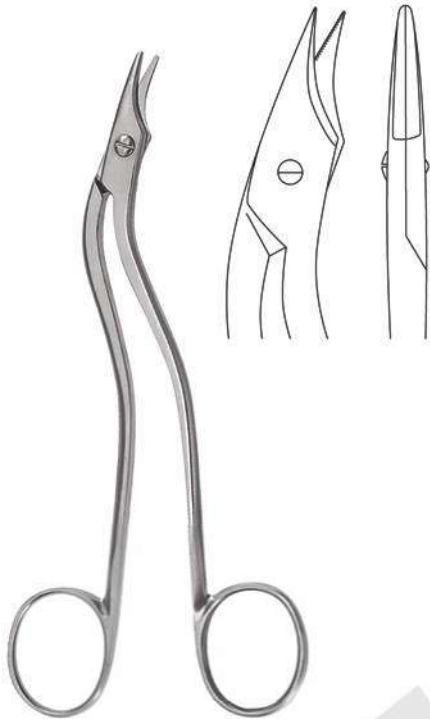

HEATH
16,0 cm, 6¹/₄"
HS-1121-16



NORTHBENT
9,0 cm, 3¹/₂"
HS-1122-09



NORTHBENT
13,0 cm, 5"
HS-1123-13



EISELSBERG
12,0 cm, 4³/₄"
HS-1124-12

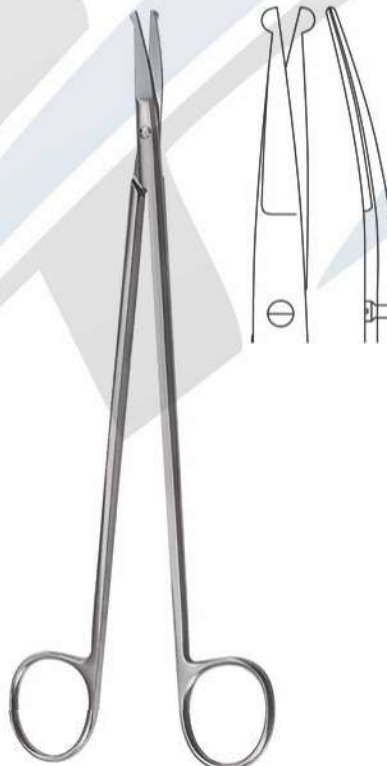

STRULLY
22,0 cm, 8⁵/₈"
HS-1125-22

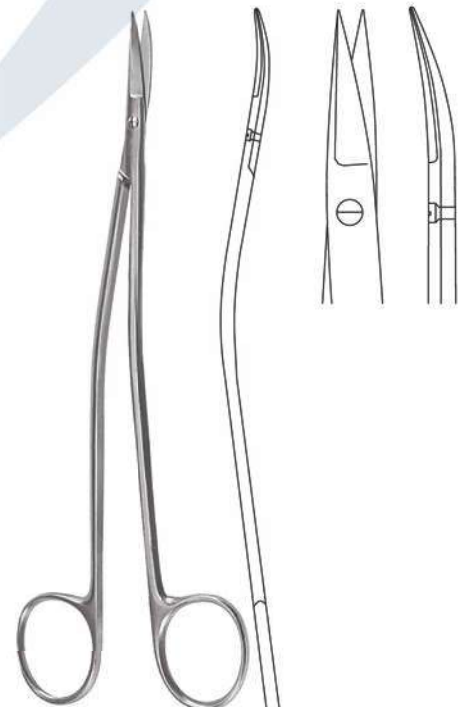

DANDY
17,0 cm, 6³/₄"
HS-1126-17

Neurochirurgische Scheren, Tonsillenscheren, Nasenscheren
 Neurosurgical Scissors, Tonsil Scissors, Nasal Scissors
 Tijeras para Neurocirugía, Tijeras para amígdalas, Tijeras para el tabique nasal
 Forbici per Neurochirurgia, Forbici per tonsille, Forbici per il setto nasale



SCHMIEDEN-TAYLOR
 17,0 cm, 6³/₄"
 HS-1127-17



LINCOLN
 17,0 cm, 6³/₄"

HS-1128-17 HS-1129-17

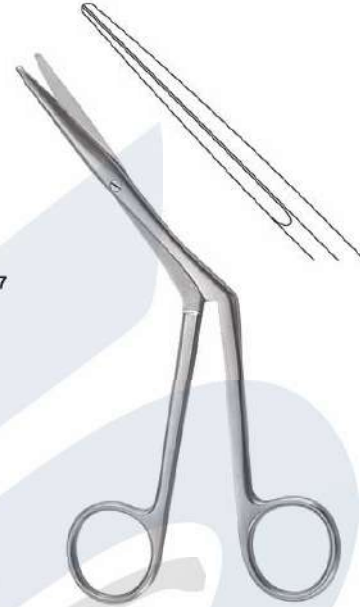

HEYMANN
 18,0 cm, 7"
 HS-1130-18



COTTLE
 16,0 cm, 6¹/₄"
 HS-1131-16

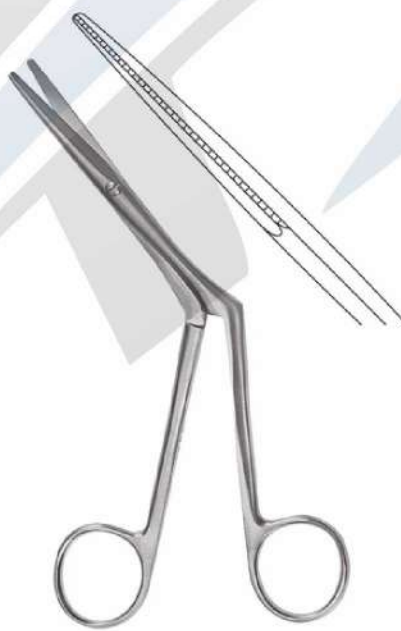

KIRSTEN
 18,0 cm, 7"
 HS-1132-18



CAPLAN
 22,0 cm, 8⁵/₈"
 HS-1133-22

Tonsillenscheren, Nasenscheren, Gefäßscheren
 Tonsil Scissors, Nasal Scissors, Vascular Scissors
 Tijeras para amígdalas, Tijeras para el tabique nasal, Tijeras vasculares
 Forbici per tonsille, Forbici per il setto nasale, Forbici vascolari



BOETTCHER
 18,0 cm, 7"
 HS-1134-18

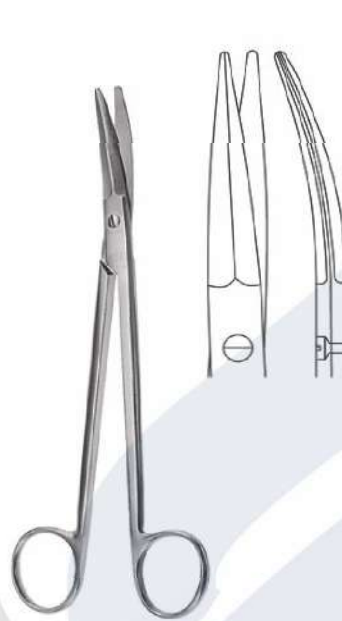

PRINCE
 17,5 cm, 6⁵/₈"
 HS-1135-17

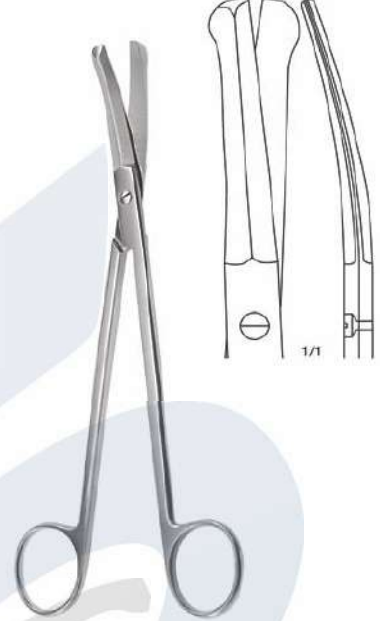

GOOD
 19,0 cm, 7¹/₂"
 HS-1136-19



CARTILAGE
 20,0 cm, 8"
 HS-1137-20



DE BAKAY

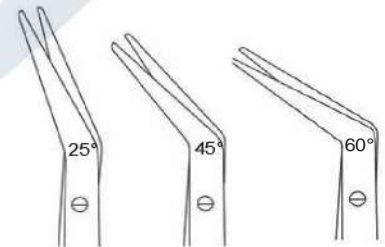

17,5 cm, 6 ⁵ / ₈ "	HS-1138-25	HS-1143-45	HS-1148-60
19,5 cm, 7 ³ / ₄ "	HS-1139-25	HS-1144-45	HS-1149-60
21,0 cm, 8 ¹ / ₄ "	HS-1140-25	HS-1145-45	HS-1150-60
23,0 cm, 9"	HS-1141-25	HS-1146-45	HS-1151-60
28,0 cm, 11"	HS-1142-25	HS-1147-45	HS-1152-60



POTTS-SMITH
18,0 cm, 7"
HS-1143-18

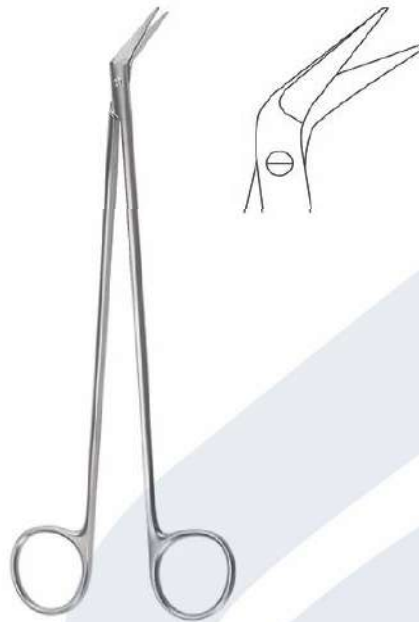

POTTS DE MARTEL
21,0 cm, 8 1/4" HS-1144-21
24,0 cm, 9 1/2" HS-1144-24



DIETRICH-HEGEMANN
19,0 cm, 7 1/2"





DIETRICH
20,0 cm, 7 1/2"
HS-1148-12

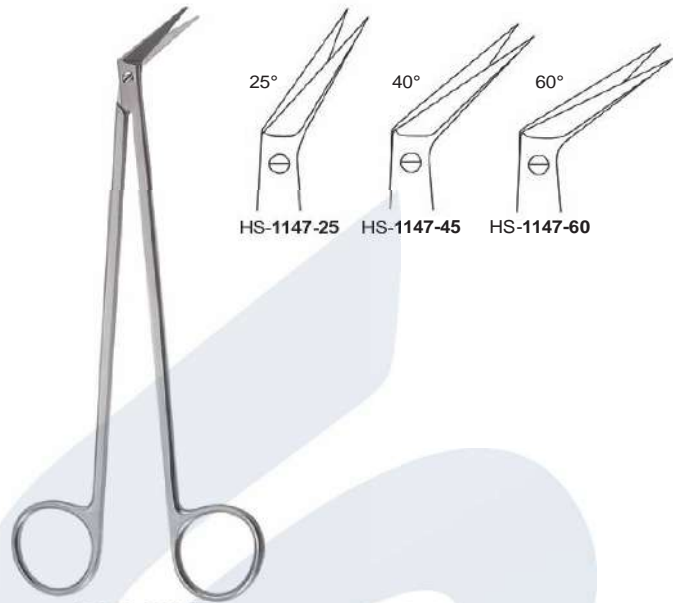

POTTS-SMITH
19,0 cm, 7 1/2"

HS-1147-25 HS-1147-45 HS-1147-60

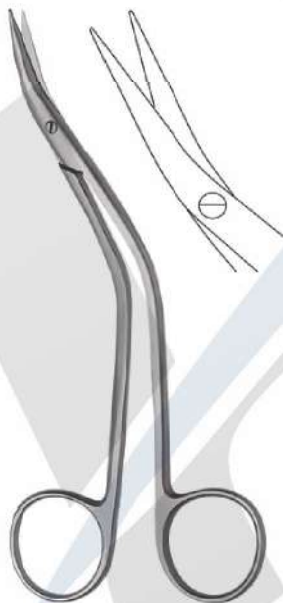

DE BAKY
15,5 cm, 6"
HS-1149-15

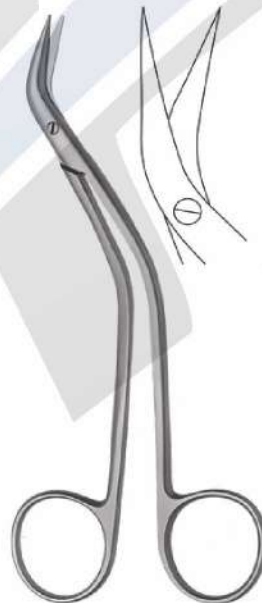

DE BAKY
15,5 cm, 6"
HS-1150-15



DE BAKY
15,5 cm, 6"
HS-1151-15



MC INDOE
19,0 cm, 7 1/2"
HS-1152-19



11,5 cm, 4 1/2"
HS-1153-11

geknöpftes Blatt
probe-pointed blade
punta botonda
lame bottonuta



CRAFOORD
30,0 cm, 12"
HS-1154-30



SATINSKY
15,5 cm, 9 5/8"
HS-1155-24



KLINGENBERG-LOTH
23,0 cm, 9"
HS-1162-23



SIMS



20,0 cm, 8" HS-1156-20 HS-1157-20 HS-1158-20
23,0 cm, 9" HS-1159-23 HS-1160-23 HS-1161-23



SIMS

20,0 cm, 8"
23,0 cm, 9"



HS-1163-20
HS-1166-23



HS-1164-20
HS-1167-23



HS-1165-20
HS-1168-23



SIEBOLD
24,0 cm, 9 1/2"
HS-1169-24



BOZEMANN
22,0 cm, 8 3/4"
HS-1170-22



DOYEN

16,0 cm, 6 1/4"
17,5 cm, 6 7/8"



HS-1171-16
HS-1174-17



HS-1172-16
HS-1175-17



HS-1173-16
HS-1176-16



KELLY

16,0 cm, 6 1/4" HS-1177-16
18,0 cm, 7" HS-1177-18

Fistelscheren
Fistula scissors
Tijeras para fistulas
Forbici per fistole



HAGGAI

S U R G I C A L

Gynäkologische Scheren, Darmscheren
Gynecology scissors, Enterotomy Scissors
Tijeras para ginecología, Tijeras enterótomas
Forbici per ginecologia, Forbici per enterotomia



Fistelscheren
Fistula scissors
Tijeras para fistulas
Forbici per fistole

KELLY

16,0 cm, 6¹/₄" HS-1179-16
18,0 cm, 7" HS-1179-18



WERTHEIM

19,5 cm, 7³/₄" HS-1180-19
22,5 cm, 8³/₄" HS-1180-23



HS-1178-18

DUBOIS

27,0 cm, 10⁵/₈"
HS-1181-18



DARMSCHERE
21,0 cm, 8¹/₄"
HS-1182-21



DARMSCHERE
21,0 cm, 8¹/₄"
HS-1183-21



**DARMSCHERE
GEKNÖPFT**
21,0 cm, 8¹/₄"
HS-1184-21



LLOYD-DAVIES
27,0 cm, 10⁵/₈"
HS-1185-27

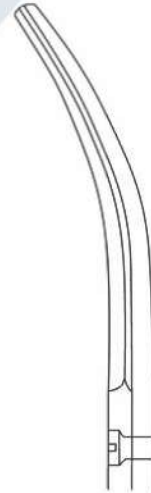

Lungenlappen- und Rektumscheren, Lungenscheren, Dammscheren
 Lobectomy and Rectal Scissors, Lobectomy Scissors, Episiotomy Scissors
 Tijeras para lobectomía y recto, Tijera para lobectomía, Tijeras para episiotomía
 Forbici per lobo polmonare e per il retto, Forbici per lobo, Forbici per episiotomia

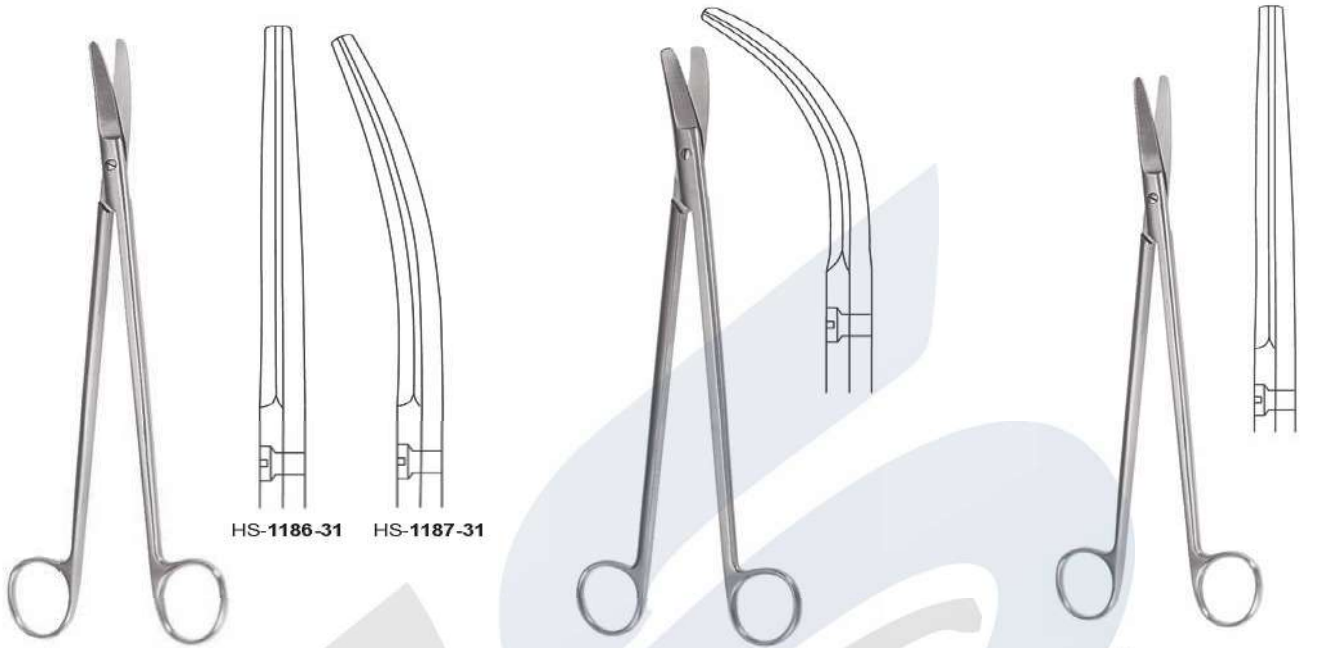

STELZNER
 31,0 cm, 12¹/₄"

HS-1186-31 HS-1187-31

RECTAL
 32,5 cm, 12³/₄"
 HS-1188-32

WILLAUER	
25,0 cm, 9 ³ / ₄ "	HS-1189-25
28,0 cm, 11"	HS-1189-28



WILLAUER	
25,0 cm, 9 ³ / ₄ "	HS-1190-25
28,0 cm, 11"	HS-1190-28

POTTS-SMITH
 19,0 cm, 7¹/₂"
 HS-1191-19

FINOCHIETTO
 32,5 cm, 10⁵/₈"
 HS-1192-27



HAGGAI

S U R G I C A L

Lungenscheren, Dammscheren, Nabelschnurscheren
Lobectomy Scissors, Episiotomy Scissors, Umbilical Cord Scissors
Tijera para lobectomía, Tijeras para episiotomía, Tijeras umbilicales
Forbici per lobo, Forbici per episiotomia, Forbici ombelicali



WALDMANN
18,0 cm, 7"
HS-1193-18



BRAUN-STADLER
14,5 cm, 5³/₄" HS-1194-14
20,0 cm, 8" HS-1194-20



EPISIOTOMIE SCHERE
20,0 cm, 8"
HS-1195-20



MOD. USA
10,5 cm, 4¹/₈"
HS-1196-10



BUSCH
13,5 cm, 5³/₈" HS-1197-13
16,0 cm, 6¹/₄" HS-1197-16



SCHUMACHER
16,0 cm, 16¹/₄"
HS-1198-16

Drahtscheren, Verband- und Kleiderstoffscheren
 Wire Scissors, Bandage and Cloth Scissors
 Cizallas corta-alambres, Tijeras para vendajes y tela
 Forbici taglia cavo, Forbici per bendaggi e vestiti



gezahnt
 serrated
 dentada
 dentata

UNIVERSAL
 12,0 cm, 4³/₄"
 HS-1200-12



LISTER

9,0 cm, 3 ¹ / ₂ "	HS-1199-09
11,0 cm, 4 ³ / ₈ "	HS-1199-11
14,0 cm, 5 ¹ / ₂ "	HS-1199-14
18,0 cm, 7"	HS-1199-18
20,0 cm, 8"	HS-1199-20



LISTER

18,5 cm, 7 ¹ / ₄ "	HS-1201-18
21,0 cm, 8 ¹ / ₄ "	HS-1201-21



gezahnt
 serrated
 dentada
 dentata

LISTER-EXCENTRIC

16,0 cm, 6 ¹ / ₄ "	HS-1202-16
19,0 cm, 7 ¹ / ₂ "	AK-1202-19



BERGMANN

23,0 cm, 9"	HS-1203-23
-------------	------------

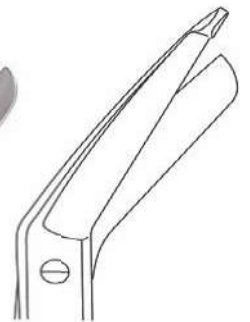



HAGGAI

S U R G I C A L

Verband- und Kleiderstoffscheren, Gipsscheren
Bandage and Cloth Scissors, Plaster-of-Paris Shears
Tijeras para vendajes y tela, Cizallas para escayolas
Forbici per bendaggi e vestiti, Cesioie per gessi



ESMARCH

20,0 cm, 8"	HS-1204-20
22,0 cm, 8 ⁵ / ₈ "	HS-1204-22



KNOWLES

14,0 cm, 5 ¹ / ₂ "	HS-1205-14
--	------------



gezahnt
serrated
dentada
dentata

BRUNS

24,0 cm, 9 ¹ / ₂ "	HS-1206-24
	HS-1207-24



LORENZ

23,0 cm, 9"	HS-1208-23
-------------	------------

bis 134°C autoklavierbar
autoclavable up to 134°C
esterilizable en autoclave hasta 134°C
Sterilizabile in autoclave fino 134°C



SMITH (MOD. USA)

16,0 cm, 6 ¹ / ₄ "	HS-1209-16
18,0 cm, 7"	HS-1209-18
20,0 cm, 8"	HS-1209-20
23,0 cm, 9"	HS-1209-23



gezahnt
serrated
dentada
dentata

GIPSSCHERE

20,0 cm, 8"	HS-1210-20
-------------	------------



gezahnt
serrated
dentada
dentata

UNIVERSAL

14,0 cm, 5 ¹ / ₂ "	HS-1211-14
16,0 cm, 6 ¹ / ₄ "	HS-1211-16
18,0 cm, 7"	HS-1211-18



HAGGAI

S U R G I C A L

Chirurgische Scheren mit Hartmetallschneiden
Surgical Scissors with tungsten carbide edges
Tijeras para cirugía con filos de carburo tungsteno
Forbici per chirurgia con lame in carburo di tungsteno



STANDARD

14,5 cm, 5 ³ / ₄ "	HS-1212-14-TC
16,5 cm, 6 ¹ / ₂ "	HS-1212-16-TC
18,5 cm, 7 ¹ / ₄ "	HS-1212-18-TC



STANDARD

14,5 cm, 5 ³ / ₄ "	HS-1213-14-TC
16,5 cm, 6 ¹ / ₂ "	HS-1213-16-TC
18,5 cm, 7 ¹ / ₄ "	HS-1213-18-TC



STANDARD

14,5 cm, 5 ³ / ₄ "	HS-1214-14-TC
16,5 cm, 6 ¹ / ₂ "	HS-1214-16-TC
18,5 cm, 7 ¹ / ₄ "	HS-1214-18-TC



STANDARD

14,5 cm, 5 ³ / ₄ "	HS-1215-14-TC
16,5 cm, 6 ¹ / ₂ "	HS-1215-16-TC
18,5 cm, 7 ¹ / ₄ "	HS-1215-18-TC



STANDARD

14,5 cm, 5 ³ / ₄ "	HS-1216-14-TC
16,5 cm, 6 ¹ / ₂ "	HS-1216-16-TC
18,5 cm, 7 ¹ / ₄ "	HS-1216-18-TC



STANDARD

14,5 cm, 5 ³ / ₄ "	HS-1217-14-TC
16,5 cm, 6 ¹ / ₂ "	HS-1217-16-TC
18,5 cm, 7 ¹ / ₄ "	HS-1217-18-TC



HAGGAI

S U R G I C A L

Chirurgische Scheren mit Hartmetallschneiden
Surgical Scissors with tungsten carbide edges
Tijeras para cirugía con filos de carburo tungsteno
Forbici per chirurgia con lame in carburo di tungsteno



MAYO

14,5 cm, 5 ³ / ₄ "	HS-1218-14-TC
17,0 cm, 6 ³ / ₄ "	HS-1218-17-TC
23,0 cm, 9"	HS-1218-23-TC



MAYO

14,5 cm, 5 ³ / ₄ "	HS-1219-14-TC
17,0 cm, 6 ³ / ₄ "	HS-1219-17-TC
23,0 cm, 9"	HS-1219-23-TC



MAYO-STILLE

15,0 cm, 6"	HS-1220-15-TC
17,0 cm, 6 ³ / ₄ "	HS-1220-17-TC



MAYO-STILLE

15,0 cm, 6"	HS-1221-15-TC
17,0 cm, 6 ³ / ₄ "	HS-1221-17-TC



LEXER

16,0 cm, 6 ¹ / ₄ "	HS-1222-16-TC
21,0 cm, 8 ¹ / ₄ "	HS-1222-21-TC



LEXER

16,0 cm, 6 ¹ / ₄ "	HS-1223-16-TC
21,0 cm, 8 ¹ / ₄ "	HS-1223-21-TC

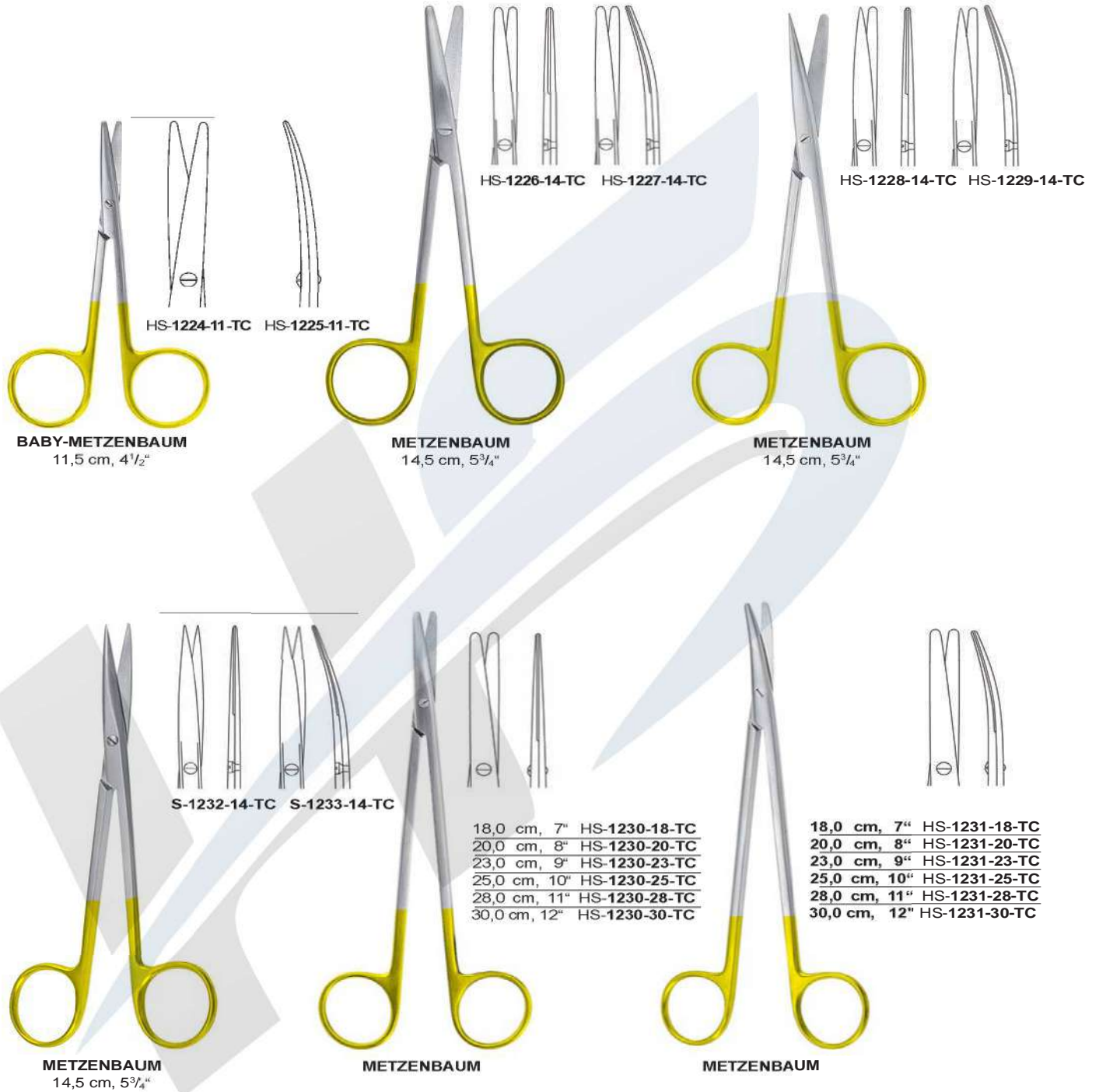



18,0 cm, 7" HS-1234-18-TC
 20,0 cm, 8" HS-1234-20-TC
 23,0 cm, 9" HS-1234-23-TC
 25,0 cm, 10" HS-1234-25-TC
 28,0 cm, 11" HS-1234-28-TC
 30,0 cm, 12" HS-1234-30-TC

METZENBAUM

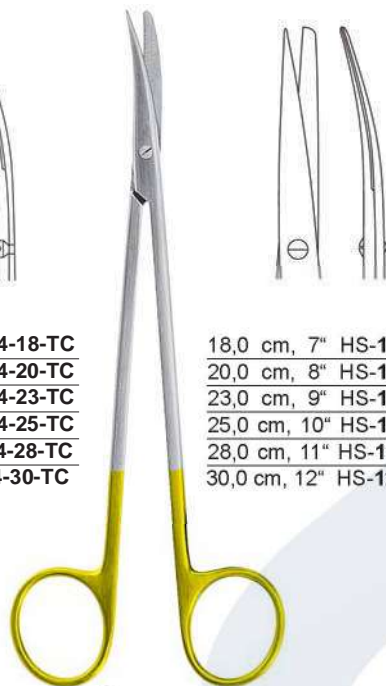

18,0 cm, 7" HS-1235-18-TC
 20,0 cm, 8" HS-1235-20-TC
 23,0 cm, 9" HS-1235-23-TC
 25,0 cm, 10" HS-1235-25-TC
 28,0 cm, 11" HS-1235-28-TC
 30,0 cm, 12" HS-1235-30-TC

METZENBAUM

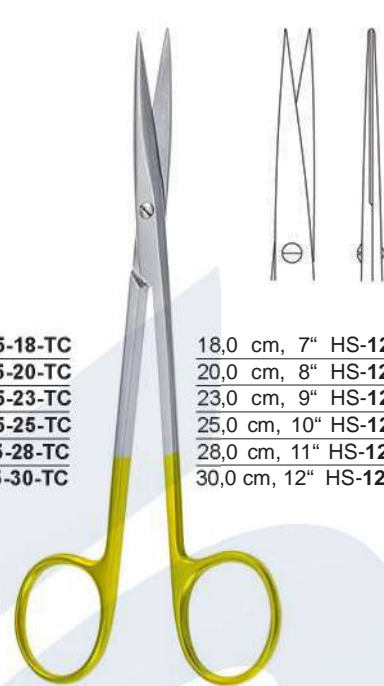

18,0 cm, 7" HS-1236-18-TC
 20,0 cm, 8" HS-1236-20-TC
 23,0 cm, 9" HS-1236-23-TC
 25,0 cm, 10" HS-1236-25-TC
 28,0 cm, 11" HS-1236-28-TC
 30,0 cm, 12" HS-1236-30-TC

METZENBAUM



18,0 cm, 7" HS-1237-18-TC
 20,0 cm, 8" HS-1237-20-TC
 23,0 cm, 9" HS-1237-23-TC
 25,0 cm, 10" HS-1237-25-TC
 28,0 cm, 11" HS-1237-28-TC
 30,0 cm, 12" HS-1237-30-TC

METZENBAUM



HS-1238-14-TC HS-1239-14-TC

METZENBAUM-FINO
 14,5 cm, 5³/₄"



HS-1240-14-TC HS-1241-14-TC

METZENBAUM-FINO
 14,5 cm, 5³/₄"



HAGGAI

S U R G I C A L

Präparierscheren mit Hartmetallschneiden
Dissecting Scissors with tungsten carbide edges
Tijeras para disección con filos de carburo tungsteno
Forbici per dissezione con lame in carburo di tungsteno



18,0 cm, 7" HS-1242-18-TC
20,0 cm, 8" HS-1242-20-TC
23,0 cm, 9" HS-1242-23-TC
25,0 cm, 10" HS-1242-25-TC
28,0 cm, 11" HS-1242-28-TC
30,0 cm, 12" HS-1242-30-TC

METZENBAUM-FINO

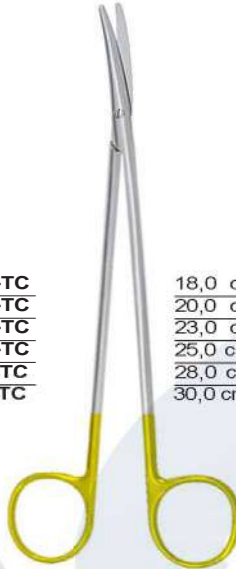

18,0 cm, 7" HS-1243-18-TC
20,0 cm, 8" HS-1243-20-TC
23,0 cm, 9" HS-1243-23-TC
25,0 cm, 10" HS-1243-25-TC
28,0 cm, 11" HS-1243-28-TC
30,0 cm, 12" HS-1243-30-TC

METZENBAUM-FINO



18,0 cm, 7" HS-1244-18-TC
20,0 cm, 8" HS-1244-20-TC
23,0 cm, 9" HS-1244-23-TC
25,0 cm, 10" HS-1244-25-TC
28,0 cm, 11" HS-1244-28-TC
30,0 cm, 12" HS-1244-30-TC

METZENBAUM-FINO

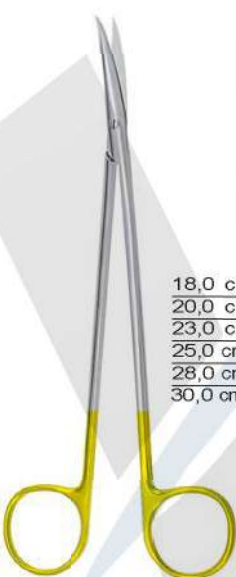

18,0 cm, 7" HS-1245-18-TC
20,0 cm, 8" HS-1245-20-TC
23,0 cm, 9" HS-1245-23-TC
25,0 cm, 10" HS-1245-25-TC
28,0 cm, 11" HS-1245-28-TC
30,0 cm, 12" HS-1245-30-TC

METZENBAUM-FINO



METZENBAUM-LAHEY
14,0 cm, 5 1/2"
HS-1246-14-TC



TOENNIS-ADSON
17,0 cm, 6 3/4"
HS-1247-17-TC



HAGGAI

S U R G I C A L

Präparierscheren mit Hartmetallschneiden
Dissecting Scissors with tungsten carbide edges
Tijeras para disección con filos de carburo tungsteno
Forbici per dissezione con lame in carburo di tungsteno



18,0 cm, 7" HS-1248-18-TC
20,0 cm, 8" HS-1248-20-TC
23,0 cm, 9" HS-1248-23-TC

METZENBAUM-FINO S



18,0 cm, 7" HS-1249-18-TC
20,0 cm, 8" HS-1249-20-TC
23,0 cm, 9" HS-1249-23-TC

METZENBAUM-FINO S



REYNOLDS
15,0 cm, 6"
HS-1250-15-TC



REYNOLDS
15,0 cm, 6"
HS-1251-15-TC



HYSTEREKTOMY
25,5 cm, 10"
HS-1252-25-TC



HYSTEREKTOMY
Y 25,0 cm, 9³/₄"
HS-1253-25-TC



HAGGAI

S U R G I C A L

Gynäkologische Scheren mit Hartmetallschneiden
Gynecology Scissors with tungsten carbide edges
Tijeras para ginecología con filos de carburo tungsteno
Forbici per ginecologia con lame in carburo di tungsteno



SIMS

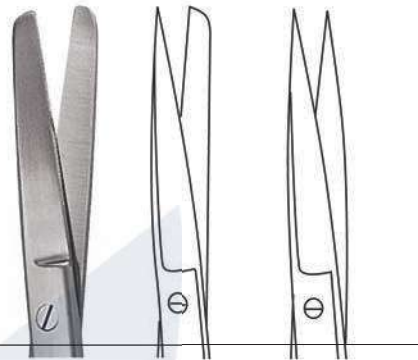

20,0 cm, 8"	HS-1254-20-TC	HS-1255-20-TC	HS-1256-20-TC
23,0 cm, 9"	HS-1254-23-TC	HS-1255-23-TC	HS-1256-23-TC



SIMS



20,0 cm, 8"	HS-1257-20-TC	HS-1258-20-TC	HS-1259-20-TC
23,0 cm, 9"	HS-1257-23-TC	HS-1258-23-TC	HS-1259-23-TC



HAGGAI

S U R G I C A L

Gefäßscheren mit Hartmetallschneiden
Vascular Scissors with tungsten carbide edges
Tijeras vasculares con filos de carburo tungsteno
Forbici vascolari con lame in carburo di tungsteno



DIETHRICH
17,5 cm, 6⁵/₈"
HS-1260-17-TC



POTTS DE MARTEL
24,0 cm, 9¹/₂"
HS-1261-24-TC



DE BAKEY

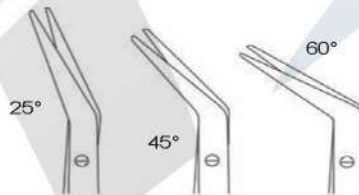

20,0 cm, 8"	HS-1262-25-TC	HS-1264-45-TC	HS-1266-60-TC
23,0 cm, 9"	HS-1263-25-TC	HS-1265-45-TC	HS-1267-60-TC



HAGGAI

S U R G I C A L

Gefäßscheren mit Hartmetallschneiden
Vascular Scissors with tungsten carbide edges
Tijeras vasculares con filos de carburo tungsteno
Forbici vascolari con lame in carburo di tungsteno



DIETRICH-HEGEMANN
18,0 cm, 7"



POTTS-SMITH
18,0 cm, 7 1/2"

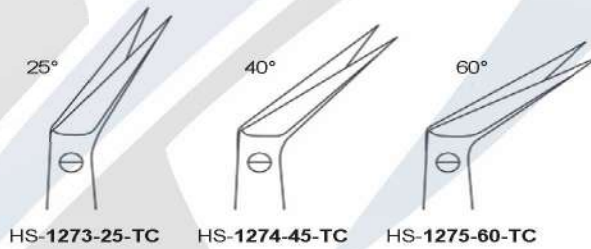



HAGGAI

S U R G I C A L

Scheren mit Hartmetallschneiden
Scissors with tungsten carbide edges
Tijeras con filos de carburo tungsteno
Forbici con lame in carburo di tungsteno



HS-1277-11-TC HS-1278-11-TC

IRIS
11,5 cm, 4 1/2"



gezahnt
serrated
dentada
dentata

UNIVERSAL
12,0 cm, 4 3/4"
HS-1279-12-TC



LISTER
18,0 cm, 7"
HS-1280-18-TC

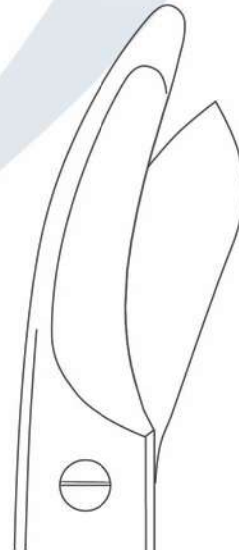

BRUNS
24,0 cm, 9 1/2"
HS-1281-24-TC



MAYO
17,0 cm, 6³/₄"

HS-1284-17-SC HS-1285-17-SC



METZENBAUM

14,5 cm, 5³/₄" HS-1282-14-SC
18,0 cm, 7" HS-1282-18-SC
20,0 cm, 8" HS-1282-20-SC
23,0 cm, 9" HS-1282-23-SC



METZENBAUM-FINO

14,5 cm, 5³/₄" HS-1283-14-SC
18,0 cm, 7" HS-1283-18-SC
20,0 cm, 8" HS-1283-20-SC
23,0 cm, 9" HS-1283-23-SC



KAYE FACE LIFT

15,0 cm, 6" HS-1286-15-SC
19,0 cm, 7¹/₂" HS-1287-19-SC



JABALEY
13,0 cm, 5"
HS-1288-13-SC



ENDARTERECTOMY
18,0 cm, 7"
HS-1289-18-SC



TOENNIS-ADSON
17,0 cm, 6³/₄"
HS-1290-17-SC

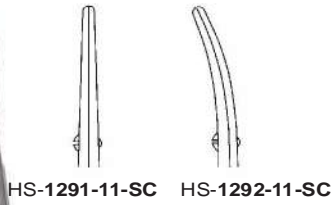

STRABISMUS
11,5 cm, 4 1/2"



JAMISON
15,0 cm, 6" HS-1293-15-SC
18,0 cm, 7" HS-1293-18-SC



REYNOLDS
12,5 cm, 5"
HS-1294-12-SC



BABY-METZENBAUM
11,0 cm, 4 3/8" HS-1295-11-SC
14,5 cm, 5 3/4" HS-1295-14-SC



IRIS
11,0 cm, 4 3/8"
HS-1296-11-SC



IRIS
11,0 cm, 4 3/8"
HS-1297-11-SC



STEVENS TENOTOMY
11,0 cm, 4 3/8"
HS-1298-11-SC



STEVENS TENOTOMY
11,0 cm, 4 3/8"
HS-1299-11-SC



PAR TYPE
 12,0 cm, 4³/₄"
 HS-1303-12-SC



PAR TYPE
 12,0 cm, 4³/₄"
 HS-1304-12-SC

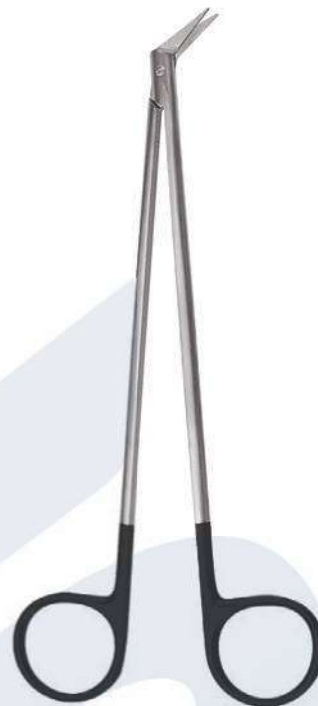

POTTS
 19,0 cm, 7¹/₂"



25°
 HS-1300-25-SC



45°
 HS-1301-45-SC



60°
 HS-1302-60-SC



FOMON
 14,5 cm, 5³/₄"
 HS-1305-15-SC



COTTLE
 16,5 cm, 6¹/₂"
 HS-1306-16-SC



S U R G I C A L



WESTCOTT
11,0 cm, 4³/₈"

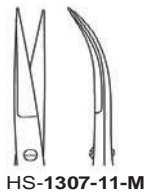

HS-1307-11-M

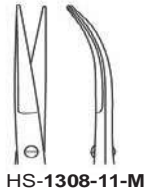

HS-1308-11-M



GOMEL

14,0 cm, 5¹/₂" HS-1312-14-M
16,0 cm, 6¹/₄" HS-1312-16-M



gezahnt
serrated
dentada
dentata



HEPP SCHEIDEL

14,0 cm, 5¹/₂" HS-1313-14-M
16,0 cm, 6¹/₄" HS-1313-16-M



Mikro-Präparierscheren
Micro-dissecting scissors
Micro-tijeras de disección
Micro-forbici per dissezione



18,5 cm, 7¹/₄"

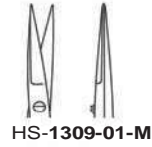

HS-1309-01-M



HS-1310-02-M

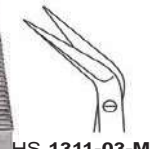

HS-1311-03-M



SIMS



18,5 cm, 7¹/₄" HS-1314-01 HS-1315-02 HS-1316-03 HS-1318-04
22,5 cm, 8³/₄" HS-1319-01 HS-1320-02 HS-1321-03 HS-1322-04



18,5 cm, 7¹/₄" HS-1323-01-M HS-1325-02-M
22,5 cm, 8³/₄" HS-1324-01-M HS-1326-02-M



HAGGAI

S U R G I C A L

Mikro-Scheren, Mikro-Disektionsscheren
Micro Scissors, Micro Dissecting Scissors
Micro-Tijeras, Micro-Tijeras de disección
Micro-Forbici, Micro-Forbici per dissezione



18,0 cm, 7"



25°
HS-1327-25-M



45°
HS-1328-45-M

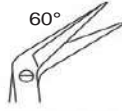

60°
HS-1329-60-M



90°
HS-1330-90-M



125°
HS-1331-12-M

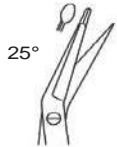

25°
HS-1332-25-M



45°
HS-1333-45-M



60°
HS-1334-60-M



90°
HS-1335-90-M



125°
HS-1336-12-M



15,0 cm, 6"
HS-1337-15-M



15,0 cm, 6"
HS-1338-15-M



gezahnt
serrated
dentada
dentata



15,0 cm, 6"
HS-1339-15-M



18,0 cm, 7"
HS-1340-18-M





HAGGAI

S U R G I C A L

Mikro-Adventitiascheren
Micro Adventitia Scissors
Micro-Tijeras Adventitia
Micro-Forbici Adventitia



15,0 cm, 6"
HS-1341-15-M



15,0 cm, 6"
HS-1342-15-M



gezahn
serrated
dentada
dentata



15,0 cm, 6"
HS-1343-15-M



18,0 cm, 7"
HS-1344-18-M

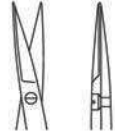

Pinzetten
Forceps
Pinzas
Pinze





STANDARD

10,5 cm, 4 1/8"	HS-1345-10
11,5 cm, 4 1/2"	HS-1345-11
13,0 cm, 5"	HS-1345-13
14,5 cm, 5 3/4"	HS-1345-14
15,0 cm, 6"	HS-1345-15
16,0 cm, 6 1/4"	HS-1345-16
18,0 cm, 7"	HS-1345-18
20,0 cm, 8"	HS-1345-20
25,0 cm, 10"	HS-1345-25
30,0 cm, 12"	HS-1345-30



schmal
narrow
estrechos
stretti

STANDARD

10,5 cm, 4 1/8"	HS-1346-10
11,5 cm, 4 1/2"	HS-1346-11
13,0 cm, 5"	HS-1346-13
14,5 cm, 5 3/4"	HS-1346-14
15,0 cm, 6"	HS-1346-15
16,0 cm, 6 1/4"	HS-1346-16
18,0 cm, 7"	HS-1346-18
20,0 cm, 8"	HS-1346-20
25,0 cm, 10"	HS-1346-25
30,0 cm, 12"	HS-1346-30



schmal
narrow
estrechos
stretti

STANDARD

10,5 cm, 4 1/8"	HS-1347-10
11,5 cm, 4 1/2"	HS-1347-11
13,0 cm, 5"	HS-1347-13
14,5 cm, 5 3/4"	HS-1347-14
15,0 cm, 6"	HS-1347-15
16,0 cm, 6 1/4"	HS-1347-16
18,0 cm, 7"	HS-1347-18
20,0 cm, 8"	HS-1347-20
25,0 cm, 10"	HS-1347-25
30,0 cm, 12"	HS-1347-30



fein
fine
finas
fini

STANDARD

10,5 cm, 4 1/8"	HS-1348-10
11,5 cm, 4 1/2"	HS-1348-11
13,0 cm, 5"	HS-1348-13
14,5 cm, 5 3/4"	HS-1348-14
15,0 cm, 6"	HS-1348-15
16,0 cm, 6 1/4"	HS-1348-16
18,0 cm, 7"	HS-1348-18
20,0 cm, 8"	HS-1348-20
25,0 cm, 10"	HS-1348-25
30,0 cm, 12"	HS-1348-30



fein
fine
finas
fni



fein
fine
finas
fni

mit Stift
with pin
con perno
con espiga



schmal
narrow
estrechos
stretti

10,5 cm, 4 ¹ / ₈ "	HS-1349-10
11,5 cm, 4 ¹ / ₂ "	HS-1349-11
13,0 cm, 5"	HS-1349-13
14,5 cm, 5 ³ / ₄ "	HS-1349-14
16,0 cm, 6 ¹ / ₄ "	HS-1349-16
18,0 cm, 7"	HS-1349-18
20,0 cm, 8"	HS-1349-20
25,0 cm, 10"	HS-1349-25
30,0 cm, 12"	HS-1349-30

10,5 cm, 4 ¹ / ₈ "	HS-1350-10
11,5 cm, 4 ¹ / ₂ "	HS-1350-11
13,0 cm, 5"	HS-1350-13
14,5 cm, 5 ³ / ₄ "	HS-1350-14
16,0 cm, 6 ¹ / ₄ "	HS-1350-16
18,0 cm, 7"	HS-1350-18
20,0 cm, 8"	HS-1350-20
25,0 cm, 10"	HS-1350-25
30,0 cm, 12"	HS-1350-30

MOD. USA

12,0 cm, 4 ³ / ₄ "	HS-1351-10
13,0 cm, 5"	HS-1351-13
14,5 cm, 5 ³ / ₄ "	HS-1351-14
15,0 cm, 6"	HS-1351-15
18,0 cm, 7"	HS-1351-18
20,0 cm, 8"	HS-1351-20
25,5 cm, 10"	HS-1351-25
30,0 cm, 12"	HS-1351-30

MOD. USA

12,0 cm, 4 ³ / ₄ "	HS-1352-11
13,0 cm, 5"	HS-1352-13
14,5 cm, 5 ³ / ₄ "	HS-1352-14
15,0 cm, 6"	HS-1352-15
18,0 cm, 7"	HS-1352-18
20,0 cm, 8"	HS-1352-20
25,5 cm, 10"	HS-1352-25



ADSON

12,0 cm, 4 ³ / ₄ "	HS-1353-12
15,0 cm, 6"	HS-1353-15



MICRO-ADSON

12,0 cm, 4 ³ / ₄ "	HS-1354-12
15,0 cm, 6"	HS-1354-15



STILLE

15,0 cm, 6"	HS-1355-15
-------------	------------



MC INDOE

15,0 cm, 6"	HS-1356-15
-------------	------------



TAYLOR

17,5 cm, 6 ⁵ / ₈ "	HS-1357-17
--	------------



TAYLOR

17,5 cm, 6 ⁵ / ₈ "	HS-1358-17
--	------------



TAYLOR

18,5 cm, 7 ¹ / ₄ "	HS-1359-18
--	------------



GERALD

18,0 cm, 7"	HS-1360-18
-------------	------------



GERALD
18,0 cm, 7"
HS-1361-18



POTTS-SMITH
18,0 cm, 7" HS-1362-18
21,0 cm, 8 1/4" HS-1362-21
25,0 cm, 10" HS-1362-25



POTTS-SMITH
18,0 cm, 7" HS-1363-18
21,0 cm, 8 1/4" HS-1363-21
25,0 cm, 10" HS-1363-25



englische Modelle
english patterns
modelos ingleses
modelli inglese

13,0 cm, 5" HS-1364-13
14,5 cm, 5 3/4" HS-1364-14
15,0 cm, 6" HS-1364-15



SEMKEN
12,5 cm, 5" HS-1365-12
15,0 cm, 6" HS-1365-15



CUSHING
17,5 cm, 6 5/8"
HS-1366-17



CUSHING
17,5 cm, 6 5/8"
HS-1367-17



BROPHY
20,0 cm, 8"
HS-1368-20



BROPHY
20,0 cm, 8"
HS-1369-20



BONNEY
18,0 cm, 7"
HS-1370-18



SINGLE-TUTTLE
23,0 cm, 9"
HS-1371-23



DENNIS BROWN
20,0 cm, 8"
HS-1372-20



DUEHRSEN
20,0 cm, 8"
HS-1373-20



WAUGH
15,0 cm, 6" HS-1374-15
20,0 cm, 8" HS-1374-20



RAMSEY
18,0 cm, 7"
HS-1375-18

1 x 2



2 x 3



3 x 4



4 x 5



STANDARD

10,5 cm, 4 1/8"	HS-1376-10
11,5 cm, 4 1/2"	HS-1376-11
13,0 cm, 5"	HS-1376-13
14,5 cm, 5 3/4"	HS-1376-14
15,0 cm, 6"	HS-1376-15
16,0 cm, 6 1/4"	HS-1376-16
18,0 cm, 7"	HS-1376-18
20,0 cm, 8"	HS-1376-20
25,0 cm, 10"	HS-1376-25
30,0 cm, 12"	HS-1376-30

11,5 cm, 4 1/2"	HS-1377-11
13,0 cm, 5"	HS-1377-13
14,5 cm, 5 3/4"	HS-1377-14
16,0 cm, 6 1/4"	
18,0 cm	HS-1377-16S-1377-18
20,0 cm, 8"	HS-1377-20
25,0 cm, 10"	HS-1377-25
30,0 cm, 12"	HS-1377-30

13,0 cm, 5"	HS-1378-13
14,5 cm, 5 3/4"	HS-1378-14
16,0 cm, 6 1/4"	
18,0 cm,	HS-1378-16S-1378-18
20,0 cm, 8"	HS-1378-20

13,0 cm, 5"	HS-1379-13
14,5 cm, 5 3/4"	HS-1379-14
16,0 cm, 6 1/4"	
18,0 cm,	HS-1379-16S-1379-18
20,0 cm, 8"	HS-1379-20



1 x 2



fein
fine
finas
fini

13,0 cm, 5"	HS-1380-13
14,5 cm, 5 ³ / ₄ "	HS-1380-14
15,5 cm, 6"	HS-1380-15
16,0 cm, 6 ¹ / ₄ "	HS-1380-16
18,0 cm, 7"	HS-1380-18
20,0 cm, 8"	HS-1380-20
25,0 cm, 10"	HS-1380-25
30,0 cm, 12"	HS-1380-30

1 x 2



mit Stift
with pin
con perno
con espiga

13,0 cm, 5"	HS-1381-13
14,5 cm, 5 ³ / ₄ "	HS-1381-14
15,5 cm, 6"	HS-1381-15
16,0 cm, 6 ¹ / ₄ "	HS-1381-16
18,0 cm, 7"	HS-1381-18
20,0 cm, 8"	HS-1381-20
25,0 cm, 10"	HS-1381-25
30,0 cm, 12"	HS-1381-30

1 x 2



mit Stift
with pin
con perno
con espiga

13,0 cm, 5"	HS-1382-13
14,5 cm, 5 ³ / ₄ "	HS-1382-14
16,0 cm, 6 ¹ / ₄ "	HS-1382-16
18,0 cm, 7"	HS-1382-18
20,0 cm, 8"	HS-1382-20

1 x 2



englische Modelle
english patterns
modelos ingleses
modelli inglese

13,0 cm, 5"	HS-1383-13
14,5 cm, 5 ³ / ₄ "	HS-1383-14
15,0 cm, 6"	HS-1383-15



1 x 2



2 x 3



1 x 2



1 x 2



MOD. USA

12,0 cm, 4 ³ / ₄ "	HS-1384-12
13,0 cm, 5"	HS-1384-13
14,5 cm, 5 ³ / ₄ "	HS-1384-14
15,5 cm, 6"	HS-1384-15
18,0 cm, 7"	HS-1384-18
20,0 cm, 8"	HS-1384-20
25,0 cm, 10"	HS-1384-25
30,0 cm, 12"	HS-1384-30

MOD. USA

12,0 cm, 4 ³ / ₄ "	HS-1385-12
13,0 cm, 5"	HS-1385-13
14,5 cm, 5 ³ / ₄ "	HS-1385-14
15,5 cm, 6"	HS-1385-15
18,0 cm, 7"	HS-1385-18
20,0 cm, 8"	HS-1385-20
25,0 cm, 10"	HS-1385-25
30,0 cm, 12"	HS-1385-30

ADSON

12,0 cm, 4 ³ / ₄ "	HS-1386-12
15,0 cm, 6"	HS-1386-15

MICRO-ADSON

12,0 cm, 4 ³ / ₄ "	HS-1387-12
15,0 cm, 6"	HS-1387-15

2 x 3



ADSON
12,0 cm, 4³/₄" HS-1388-12
15,0 cm, 6" HS-1388-15

7 x 7



ADSON-BROWN
12,0 cm, 4³/₄" HS-1389-12
15,0 cm, 6" HS-1389-15

1 x 2



ADSON
12,0 cm, 4³/₄" HS-1390-12

1 x 2



STILLE
15,0 cm, 6" HS-1391-15

2 x 3



STILLE
15,0 cm, 6" HS-1392-15

1 x 2



GILLIES
15,0 cm, 6" HS-1393-15

2 x 3



ADLERKREUTZ
15,0 cm, 6" HS-1394-15
20,0 cm, 8" HS-1394-20

4 x 5



ADLERKREUTZ
15,0 cm, 6" HS-1395-15
20,0 cm, 8" HS-1395-20



1 x 2



SEMKEN
12,5 cm, 5" HS-1396-12
15,5 cm, 6" HS-1396-15

2 x 3



SEMKEN
12,5 cm, 5" HS-1397-12

1 x 2



MC INDOE
15,0 cm, 6" HS-1398-15

1 x 2



TAYLOR
17,5 cm, 6⁵/₈" HS-1399-17

1 x 2



TAYLOR
17,5 cm, 6⁵/₈" HS-1400-17

1 x 2



TAYLOR
17,5 cm, 6⁵/₈" HS-1401-17

1 x 2



GERALD
18,0 cm, 7" HS-1402-18

1 x 2



GERALD
18,0 cm, 7" HS-1403-18

1 x 2



CUSHING
17,5 cm, 6⁷/₈"
HS-1404-17

1 x 2



CUSHING
17,5 cm, 6⁷/₈"
HS-1405-17

1 x 2



POTTS-SMITH
18,0 cm, 7" HS-1406-18
21,0 cm, 8¹/₄" HS-1406-21
25,0 cm, 10" HS-1406-25

1 x 2



POTTS-SMITH
18,0 cm, 7" HS-1407-18
21,0 cm, 8¹/₄" HS-1407-21
25,0 cm, 10" HS-1407-25

1 x 2



WAUGH
15,0 cm, 6" HS-1408-15
20,0 cm, 8" HS-1408-20

1 x 2



BROPHY
20,0 cm, 8"
HS-1409-20

x 2



BROPHY
20,0 cm, 8"
HS-1410-20



RUSS. MODELL
15,0 cm, 6" HS-1411-15
20,0 cm, 8" HS-1411-20
25,0 cm, 10" HS-1411-25



DURANTE

14,5 cm, 5 ³ / ₄ "	HS-1413-14
16,0 cm, 6 ¹ / ₄ "	HS-1413-16
20,0 cm, 8"	HS-1413-20



DUEHRSEN

20,0 cm, 8"



1 x 2
HS-1412-12



2 x 3
HS-1412-23



1 x 4
HS-1412-34



NELSON

15,0 cm, 6"	HS-1414-15
20,0 cm, 8"	HS-1414-20
23,0 cm, 9"	HS-1414-23



DUVAL

14,0 cm, 5¹/₂"



Fig. 1
HS-1415-14



Fig. 2
HS-1416-14



COLLIN-DUVAL

20,0 cm, 8"



Fig. 1
HS-1417-01



Fig. 2
HS-1418-02



Fig. 3
HS-1419-03

1 x 2



LANE

14,5 cm, 5 ³ / ₄ "	HS-1420-14
20,0 cm, 8"	HS-1420-20

2 x 3



LANE

14,5 cm, 5 ³ / ₄ "	HS-1421-14
20,0 cm, 8"	HS-1421-20

7 x 7



BROWN

15,0 cm, 6"	HS-1422-15
20,0 cm, 8"	HS-1422-20
25,0 cm, 10"	HS-1422-25

1 x 2



TREVES

13,0 cm, 5"	HS-1423-13
15,0 cm, 6"	HS-1423-15

1 x 2



RAMSEY
18,0 cm, 7"
HS-1424-18

2 x 3



RAMSEY
18,0 cm, 7"
HS-1425-18

1 x 2



RAMSEY
18,0 cm, 7"
HS-1426-18

2 x 3



RAMSEY
18,0 cm, 7"
HS-1427-18



gerieft



8,0 cm, 3 1/4"	HS-1428-08
9,0 cm, 3 1/2"	HS-1428-09
10,5 cm, 4 1/8"	HS-1428-10
11,5 cm, 4 1/2"	HS-1428-11
13,0 cm, 5"	HS-1428-13
14,5 cm, 5 1/2"	HS-1428-14

gebogen
gerieft



8,0 cm, 3 1/4"	HS-1429-08
9,0 cm, 3 1/2"	HS-1429-09
10,5 cm, 4 1/8"	HS-1429-10
11,5 cm, 4 1/2"	HS-1429-11
13,0 cm, 5"	HS-1429-13
14,5 cm, 5 1/2"	HS-1429-14

mit Stift



8,0 cm, 3 1/4"	HS-1430-08
9,0 cm, 3 1/2"	HS-1430-09
10,5 cm, 4 1/8"	HS-1430-10
11,5 cm, 4 1/2"	HS-1430-11
13,0 cm, 5"	HS-1430-13
14,5 cm, 5 1/2"	HS-1430-14

mit Stift
gebogen
gerieft



8,0 cm, 3 1/4"	HS-1431-08
9,0 cm, 3 1/2"	HS-1431-09
10,5 cm, 4 1/8"	HS-1431-10
11,5 cm, 4 1/2"	HS-1431-11
13,0 cm, 5"	HS-1431-13
14,5 cm, 5 1/2"	HS-1431-14



HAGGAI

S U R G I C A L

Splitterpinzetten, Mikro-Pinzetten
Splinter Forceps, Micro Forceps
Pinzas para espinas, Pinzas para microscopia
Pinze per schegge, Pinze per microscopia



HUNTER
10,5 cm, 4 1/4"
HS-1432-10



HUNTER
10,5 cm, 4 1/4"
HS-1433-10



WALTER-CARMALT
10,5 cm, 4 1/4"
HS-1434-10



WALTER-CARMALT
10,5 cm, 4 1/4"
HS-1435-10



FEILCHENFELD
7,5 cm, 3 1/8" HS-1436-07
9,0 cm, 3 1/2" HS-1436-09
11,5 cm, 4 1/2" HS-1436-11



10,0 cm, 4"
HS-1437-10



10,0 cm, 4"
HS-1438-10



10,0 cm, 4"
HS-1439-10
selbsthaltend
glatt



HAGGAI

S U R G I C A L

Mikro-Pinzetten
Micro Forceps
Pinzas para microscopia
Pinze per microscopia



GRAEFE
10,0 cm, 4"
HS-1440-10



GRAEFE
10,0 cm, 4"
HS-1441-10



GRAEFE
10,0 cm, 4"
HS-1442-10



GRAEFE
10,0 cm, 4"
HS-1443-10



GRAEFE
10,0 cm, 4"
HS-1444-10



GRAEFE
10,0 cm, 4"
HS-1445-10



Fig. 3
11,5 cm, 4 1/2"
HS-1446-03



Fig. 4
11,5 cm, 4 1/2"
HS-1447-04



Fig. 5
11,5 cm, 4 1/2"
HS-1448-05



Fig. 7
11,5 cm, 4 1/2"
HS-1449-07

0,3 mm x 45°



9 mm

11,0 cm, 4 3/8"
HS-1450-01

0,3 mm x 90°



9 mm

11,0 cm, 4 3/8"
HS-1451-02

0,3 mm



9 mm

11,0 cm, 4 3/8"
HS-1452-03

0,3 mm x 45°



9 mm

diamantbeschichtet
diamond coated
diamantado
diamantato

11,0 cm, 4 3/8"
HS-1453-04



HAGGAI

Gefäßdilatoren, Atraumatische Pinzetten
Vessel Dilators, Atraumatic Forceps
Dilatadores vasculares, Pinzas atraumáticas
Dilatatori vascolari, Pinze anatomiche atraumatica

0,3 mm

S U R G I C A L

0,3 mm x 45°



9 mm

12,0 cm, 4³/₄"
HS-1454-12



9 mm

13,5 cm, 5³/₈"
HS-1455-13



9 mm

13,5 cm, 5³/₈"
HS-1456-13



9 mm

13,5 cm, 5³/₈"
HS-1457-13



1,5 mm

2,0 mm

2,4 mm

2,8 mm



16,0 cm, 6 ¹ / ₄ "	HS-1458-16	HS-1459-16	HS-1460-16	HS-1461-16
20,0 cm, 8"	HS-1458-20	HS-1459-20	HS-1460-20	HS-1461-20
24,0 cm, 9 ¹ / ₂ "	HS-1458-24	HS-1459-24	HS-1460-24	HS-1461-24
30,0 cm, 12"	HS-1458-30	HS-1459-30	HS-1460-30	HS-1461-30

2,8 mm

3,5 mm

3,5 mm



16,0 cm, 6 ¹ / ₄ "	HS-1462-16	HS-1463-16	HS-1464-16
20,0 cm, 8"	HS-1462-20	HS-1463-20	HS-1464-20
24,0 cm, 9 ¹ / ₂ "	HS-1462-24	HS-1463-24	HS-1464-24
30,0 cm, 12"	HS-1462-30	HS-1463-30	HS-1464-30



1,5 mm

2,0 mm



16,0 cm, 6 ¹ / ₄ "	HS-1465-16	HS-1466-16
20,0 cm, 8"	HS-1465-20	HS-1466-20
24,0 cm, 9 ¹ / ₂ "	HS-1465-24	HS-1466-24
30,0 cm, 12"	HS-1465-30	HS-1466-30

DE BAKEY

DE BAKEY



HAGGAI

S U R G I C A L

Pinzette mit Hartmetalleinlagen
Forceps with tungsten carbide inserts
Pinzas con bocas de carburo tungsteno
Pinze con morsi in carburo di tungsteno

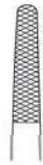

STANDARD

14,5 cm, 5 ³ / ₄ "	HS-1467-14
16,0 cm, 6 ¹ / ₄ "	HS-1467-16
18,0 cm, 7"	HS-1467-18
20,0 cm, 8"	HS-1467-20
25,0 cm, 10"	HS-1467-25
30,0 cm, 12"	HS-1467-30



STANDARD

14,0 cm, 5 ¹ / ₂ "	HS-1468-14
16,0 cm, 6 ¹ / ₄ "	HS-1468-16
18,0 cm, 7"	HS-1468-18
20,0 cm, 8"	HS-1468-20
25,0 cm, 10"	HS-1468-25
30,0 cm, 12"	HS-1468-30



STANDARD

12,5 cm, 5"	HS-1469-12
15,0 cm, 6"	HS-1469-15



STANDARD

15,0 cm, 6"	HS-1470-15
23,0 cm, 9"	HS-1470-23
25,0 cm, 10"	HS-1470-25



HAGGAI

S U R G I C A L

Pinzette mit Hartmetalleinlagen
Forceps with tungsten carbide inserts
Pinzas con bocas de carburo tungsteno
Pinze con morsi in carburo di tungsteno



GILLIES
15,0 cm, 6"
HS-1471-15



MC INDOE
15,0 cm, 6"
HS-1472-15



HS-1474-17



HS-1475-17



POTTS-SMITH

15,0 cm, 6"	HS-1473-15
18,0 cm, 7"	HS-1473-18
20,0 cm, 8"	HS-1473-20



BONNEY
17,5 cm, 6⁷/₈"
HS-1481-17



HS-1476-17

CUSHING
17,5 cm, 6⁷/₈"



HS-1477-17



CUSHING-TAYLOR
18,0 cm, 7"
HS-1482-18



12,0 cm, 4³/₄"
HS-1478-12

12,0 cm, 4³/₄"
HS-1479-12

15,0 cm, 6"
HS-1480-15

15,0 cm, 6"
HS-1483-15

ADSON
17,5 cm, 6⁷/₈"

Tuch-, Schlauchklemmen, Tupferzangen

Towel Clamps, Sponge and Dressing Forceps, Tubing Clamps

Pinzas de campo, Pinzas para vendajes y torundas y para tubos

Pinze per fissare le compresse, per medicatura e tamponi, e per tubi





SCHAEDEL
9,0 cm, 3 1/2"
HS-1484-09



ENGL. MODELL
9,0 cm, 3 1/2"
HS-1485-09



JONES	
5,0 cm, 2"	HS-1486-05
7,0 cm, 2 3/4"	HS-1486-07
9,0 cm, 3 1/2"	HS-1486-09



JONES
9,0 cm, 3 1/2"
HS-1487-09



BACKHAUS	
9,0 cm, 3 1/2"	HS-1488-09
11,0 cm, 4 3/8"	HS-1488-11
13,0 cm, 5"	HS-1488-13
15,0 cm, 6"	HS-1488-15



mit Schlauch- oder Kabelhalter
with clip for tubing or cable
con porta-tubo o porta-cable
con porta-tubo o porta-cavo

11,0 cm, 4 3/8"
HS-1489-11



ROEDER
13,0 cm, 5"
HS-1490-13



ROEDER
15,0 cm, 5"
HS-1491-15



BERNHARD
16,5 cm, 6 1/2"
HS-1492-16



13,0 cm, 5"
HS-1493-13

Kugel / Pfanne
Ball / Socket
Bola / Cojinete
Palla / Cuscinetto



LORNA



10,0 cm, 4"
HS-1494-10



13,0 cm, 5"
HS-1494-13



LANE

15,0 cm, 6"	HS-1495-15
18,0 cm, 7"	HS-1495-18
20,0 cm, 8"	HS-1495-20



HAGGAI

S U R G I C A L

Tuchklemmen, Korn- und Tupferzangen
Towel Clamps, Sponge and Dressing Forceps
Pinzas de campo, Pinzas para vendajes y torundas
Pinze per fissare le compresse, Pinze per medicatura e tamponi



TOHOKU



10,0 cm, 4"
HS-1496-10

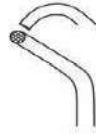

13,0 cm, 5"
HS-1496-13



PEERS
14,5 cm, 5³/₄"
HS-1497-14



LISTER

13,0 cm, 5"	HS-1498-13
16,0 cm, 6 ¹ / ₄ "	HS-1498-16
18,0 cm, 7"	HS-1498-18



BRYANT

13,0 cm, 5"
HS-1499-13



BOZEMANN

26,0 cm, 10¹/₄"
HS-1500-26



HAGGAI

S U R G I C A L

Korn- und Tupferzangen
Sponge and Dressing Forceps
Pinzas para vendajes y torundas
Pinze per medicatura e tamponi

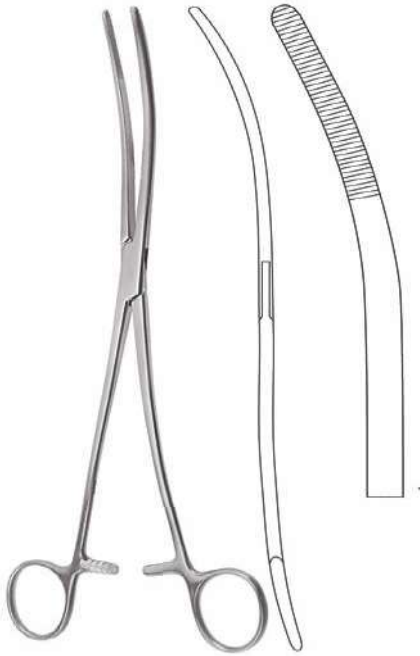

BOZEMANN
26,0 cm, 10¹/₄"
HS-1501-26



COLLIN
25,0 cm, 9³/₄"
HS-1502-25



CHERON
25,0 cm, 9³/₄"
HS-1503-25



PERLKAMM
25,0 cm, 9³/₄"



HS-1504-25



HS-1505-25



ULRICH

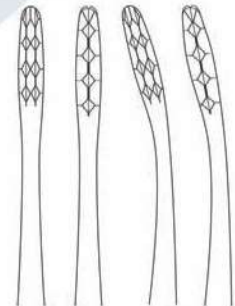

22,0 cm, 8 ⁵ / ₈ "	HS-1506-22	HS-1507-22
25,0 cm, 9 ³ / ₄ "	HS-1506-25	HS-1507-25
27,0 cm, 10 ² / ₈ "	HS-1506-27	HS-1507-27



GROSS-MAIER

20,0 cm, 8"	HS-1508-20	HS-1509-20
22,0 cm, 8 ⁵ / ₈ "	HS-1508-22	HS-1509-22
25,0 cm, 9 ³ / ₄ "	HS-1508-25	HS-1509-25
27,0 cm, 10 ⁵ / ₈ "	HS-1508-27	HS-1509-27

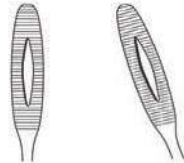

FOERSTER

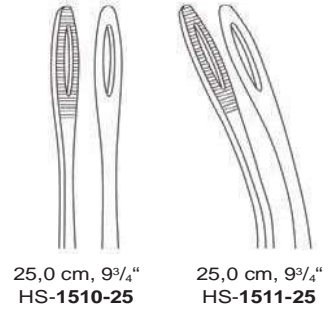

25,0 cm, 9³/₄"
HS-1510-25

25,0 cm, 9³/₄"
HS-1511-25



FOERSTER-BALLEGER

18,0 cm, 7"	HS-1512-18	HS-1513-18	HS-1514-18	HS-1515-18
20,0 cm, 8"	HS-1512-20	HS-1513-20	HS-1514-20	HS-1515-20
25,0 cm, 9 ³ / ₄ "	HS-1512-25	HS-1513-25	HS-1514-25	HS-1515-25



RAMPLEY

18,0 cm, 7"	HS-1516-18
25,0 cm, 9 ³ / ₄ "	HS-1516-25



PRESBYTERIAN
16,5 cm, 6½" HS-1517-16
18,0 cm, 7" HS-1517-18
20,0 cm, 8" HS-1517-20

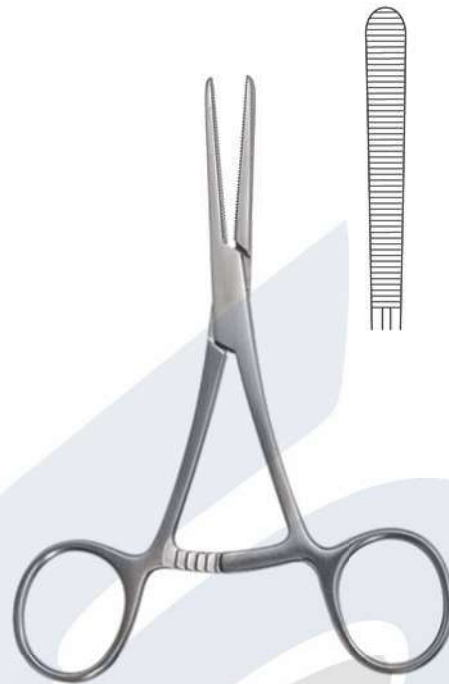

BERLIN
14,5 cm, 5¾" HS-1518-14

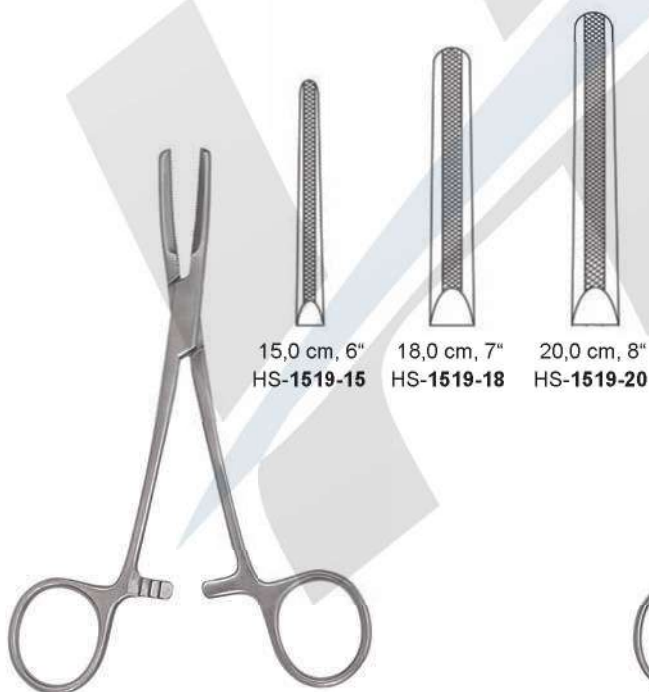

15,0 cm, 6" HS-1519-15
18,0 cm, 7" HS-1519-18
20,0 cm, 8" HS-1519-20

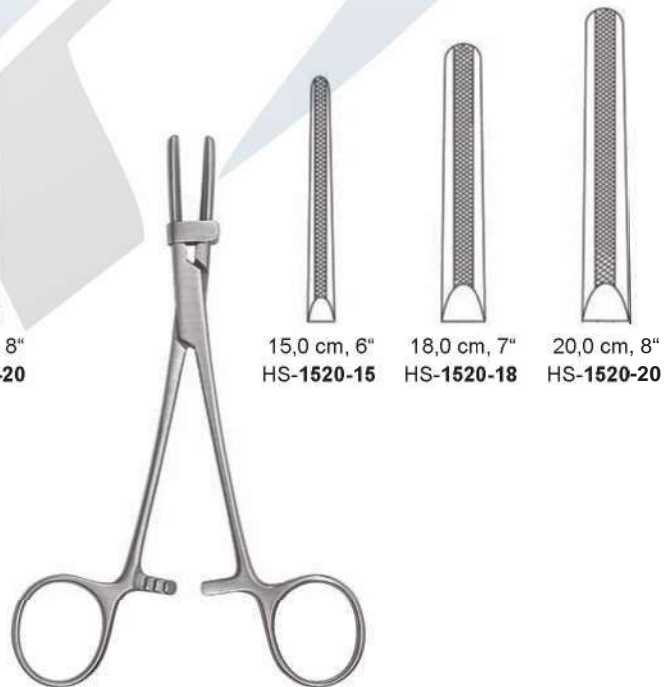

15,0 cm, 6" HS-1520-15
18,0 cm, 7" HS-1520-18
20,0 cm, 8" HS-1520-20

MIT BÜGEL



HAGGAI

S U R G I C A L

Klemmen

Forceps

Pinas

Pinze





3,5 cm, 1 1/2"
5,0 cm, 2"

HS-1521-03 HS-1522-03
HS-1521-05 HS-1522-05



HESS
HS-1523-01



HESS
HS-1524-02



3,8 cm, 1 1/2"
5,0 cm, 2"
6,3 cm, 2 1/2"
7,6 cm, 3"
9,0 cm, 3 1/2"

HS-1525-04 HS-1526-04
HS-1525-05 HS-1526-05
HS-1525-06 HS-1526-06
HS-1525-07 HS-1526-07
HS-1525-09 HS-1526-09

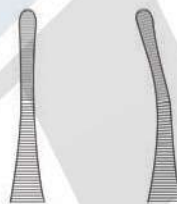

JOHNS-HOPKINS



JOHNS-HOPKINS
23,0 cm, 9"
HS-1527-23



mit atraumatischer Riefung
with non-traumatic serration
con bocas atraumáticas
con presa atraumatica

		L	
7,5 cm, 3"	HS-1528-07	2,5 cm, 1"	
8,5 cm, 3 ¹ / ₄ "	HS-1528-08	3,5 cm, 1 ³ / ₈ "	
10,5 cm, 4 ¹ / ₈ "	HS-1528-10	5,0 cm, 2"	
12,0 cm, 4 ³ / ₄ "	HS-1528-12	6,8 cm, 2 ³ / ₄ "	

DE BAKEY



mit atraumatischer Riefung
with non-traumatic serration
con bocas atraumáticas
con presa atraumatica

		L	
7,0 cm, 2 ³ / ₄ "	HS-1529-07	2,5 cm, 1"	
8,0 cm, 3 ¹ / ₈ "	HS-1529-08	3,5 cm, 1 ³ / ₈ "	
10,0 cm, 3 ³ / ₄ "	HS-1529-10	5,0 cm, 2"	
11,5 cm, 4 ¹ / ₂ "	HS-1529-12	6,8 cm, 2 ³ / ₄ "	

DE BAKEY



TITANIUM

3,5 cm, 1³/₈"
vena HS-1530-35
arteria HS-1531-35



TITANIUM

3,5 cm, 1³/₈"
vena HS-1532-35
arteria HS-1533-35



TITANIUM

4,0 cm, 1⁵/₈"
vena HS-1534-40
arteria HS-1535-40



TITANIUM

4,0 cm, 1⁵/₈"
vena HS-1536-40
arteria HS-1537-40



HAGGAI

S U R G I C A L

Bulldogklemmen, Darm- und Gewebefaßzangen
Bulldog Clamps, Intestinal and Tissue Grasping Forceps
Clamps Bulldog, Pinzas intestinales y para tejidos
Pinze Bulldog, Pinze da presa per intestino e tessuti

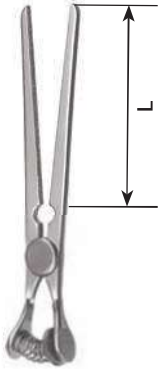

GLOVER

		L	
6,8 cm, 2 ³ / ₄ "	HS-1538-07	3,3 cm, 1 ³ / ₈ "	
9,6 cm, 3 ³ / ₄ "	HS-1538-09	5,0 cm, 2"	
11,7 cm, 4 ³ / ₄ "	HS-1538-11	6,9 cm, 2 ³ / ₄ "	

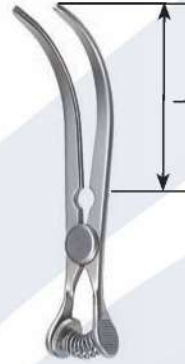

GLOVER

		L	
6,5 cm, 2 ¹ / ₂ "	HS-1539-06	3,3 cm, 1 ³ / ₈ "	
9,1 cm, 3 ¹ / ₂ "	HS-1539-09	5,0 cm, 2"	
11,0 cm, 4 ³ / ₈ "	HS-1539-11	6,9 cm, 2 ³ / ₄ "	



CHAPUT
13,0 cm, 5"
HS-1540-13



TUFFIER
13,0 cm, 5"
HS-1541-13



COLLIN
16,0 cm, 6¹/₄"
HS-1542-16



PENNINGTON

15,5 cm, 6" HS-1543-15
20,0 cm, 8" HS-1543-20



ATRAUMA



25,0 cm, 9³/₄"
HS-1544-25



27,0 cm, 10¹/₂"
HS-1544-27



MARTEL

14,0 cm, 5¹/₂"
HS-1545-14



WILLET-MARTEL

19,0 cm, 7¹/₂"
HS-1546-19



PRATT
15,0 cm, 6"
HS-1549-15



FERGUSSON

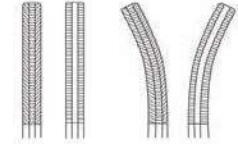

16,0 cm, 6³/₄" HS-1547-16 HS-1548-16
20,0 cm, 8" HS-1547-20 HS-1548-20



CARREL
10,0 cm, 4"
HS-1550-10



TERRIER
10,0 cm, 4"
HS-1551-10



KROENLEIN
13,0 cm, 5"
HS-1552-13



PEAN

14,0 cm, 5 1/2" HS-1555-14
16,0 cm, 6 1/4" HS-1555-16



BABY-MIXTER

14,0 cm, 5 1/2"

HS-1553-01

HS-1554-02



SPENCER-WELLS

13,0 cm, 5" HS-1556-13 HS-1557-13
15,0 cm, 6" HS-1556-15 HS-1557-15
18,0 cm, 7" HS-1556-18 HS-1557-18
20,0 cm, 8" HS-1556-20 HS-1557-20



HARTMANN

10,0 cm, 4"

HS-1558-10

HS-1559-10

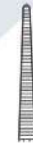

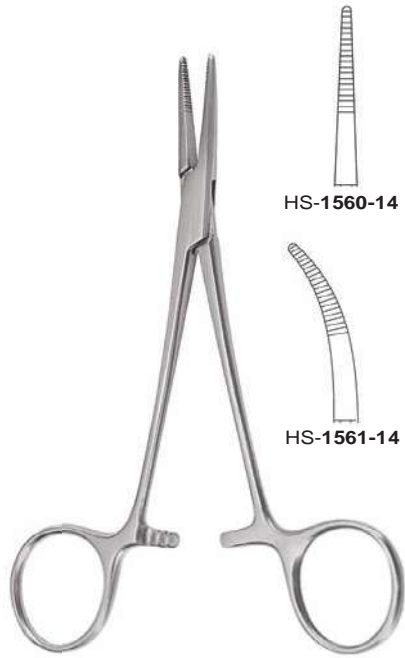

PROVICENCE-HOSPITAL
14,0 cm, 5 1/2"

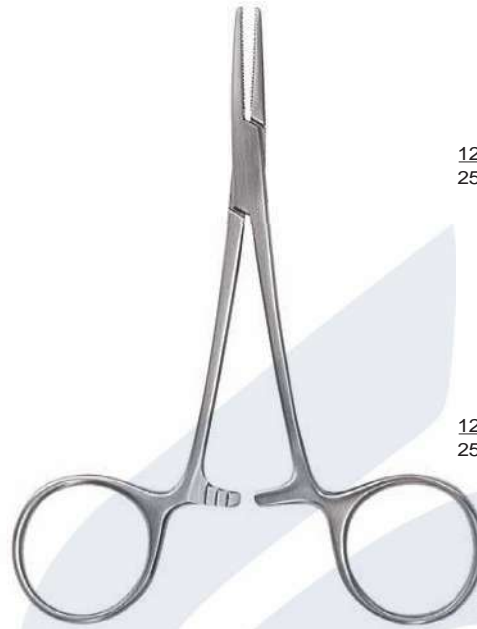

HALSTED-MOSQUITO

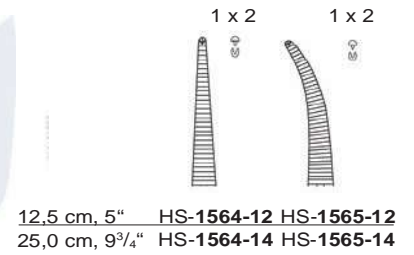
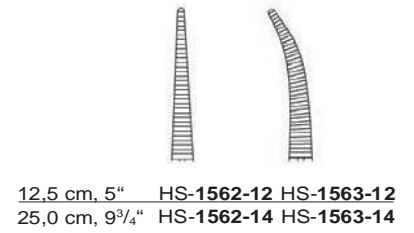

HALSTED-MOSQUITO

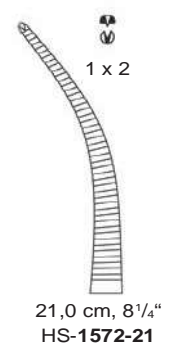
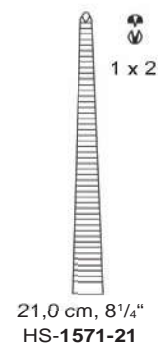
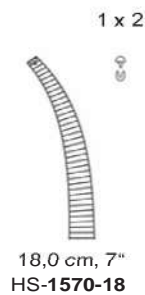
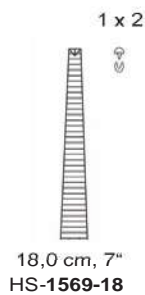
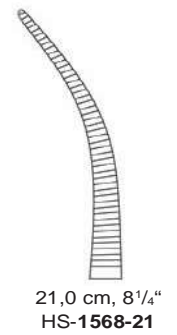
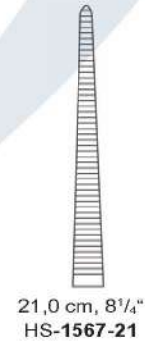



1 x 2

1 x 2

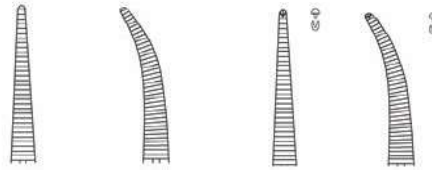

10,0 cm, 4" HS-1573-10 HS-1574-10 HS-1575-10 HS-1576-10
12,0 cm, 4 3/4" HS-1573-12 HS-1574-12 HS-1575-12 HS-1576-12



MICRO-MOSQUITO



HS-1577-14



HS-1578-14



KELLY
14,0 cm, 5 1/2"



HS-1579-16



HS-1580-16



KELLY-RANKIN
16,0 cm, 6 1/4"



LERICHE
15,0 cm, 6"



HS-1581-15



HS-1582-15

1 x 2



HS-1583-15

1 x 2



HS-1584-15



BABY-OVERHOLT 13,5
cm, 5 1/4"
HS-1585-14



DANDY
14,0 cm, 5 1/2"

1 x 2



HS-1586-14



CRILE
14,0 cm, 5 1/2"



HS-1587-14



HS-1588-14

1 x 2



HS-1589-14

1 x 2



HS-1590-14



DIXON-LOVELACE
15,0 cm, 6"

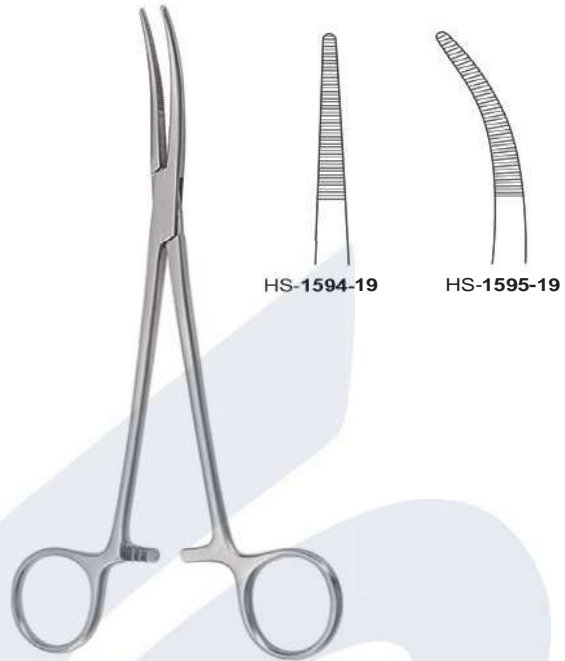
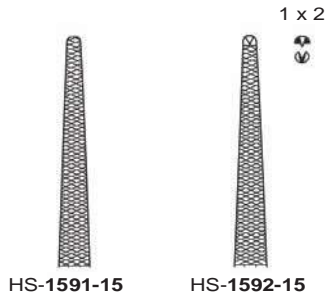

BIRKETT
19,0 cm, 7 1/2"

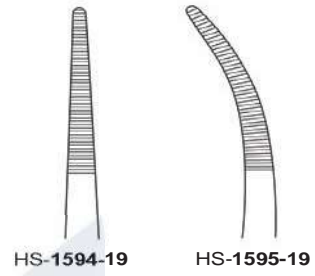

CRILE-RANKIN
16,0 cm, 6 1/4"

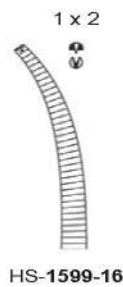
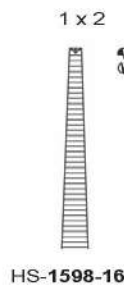

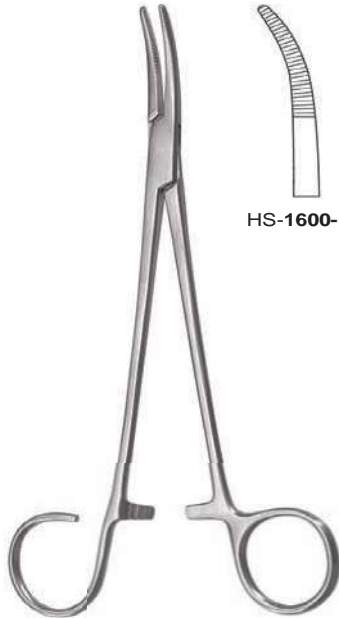

SCHNIDT
19,0 cm, 7 1/2"



HS-1600-19



HS-1601-19

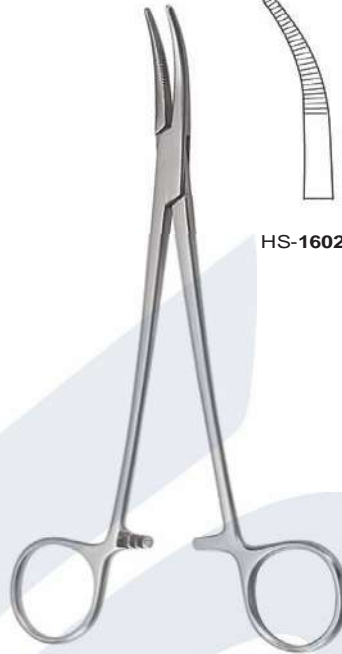

SCHNIDT-SAWTELL
19,0 cm, 7 1/2"



HS-1602-19



HS-1603-19



ADSON
18,5 cm, 7 1/4"



HS-1604-16



HS-1605-16



HS-1606-16

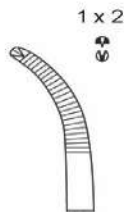

HS-1607-16



CRAFOORD
24,0 cm, 9 1/2"
HS-1608-24

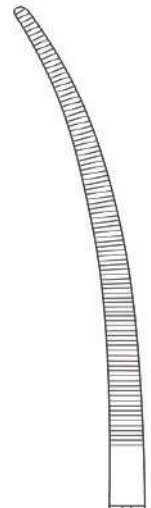



BAINBRIDGE

15,0 cm, 6" HS-1609-15 HS-1610-15
18,5 cm, 7 1/4" HS-1609-18 HS-1610-18

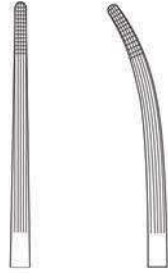

ROCHESTER-CARMALT

16,0 cm, 6 1/4" HS-1611-16 HS-1612-16
20,0 cm, 8" HS-1611-20 HS-1612-20

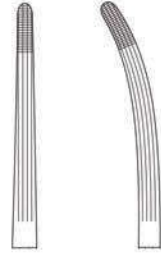

PEAN DELICATE

13,0 cm, 5" HS-1613-13 HS-1614-13
14,0 cm, 5 1/2" HS-1613-14 HS-1614-14
16,0 cm, 6 1/4" HS-1613-16 HS-1614-16

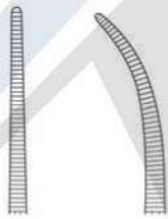

KOCHER DELICATE

13,0 cm, 5" HS-1615-13 HS-1616-13
14,0 cm, 5 1/2" HS-1615-14 HS-1616-14
16,0 cm, 6 1/4" HS-1615-16 HS-1616-16

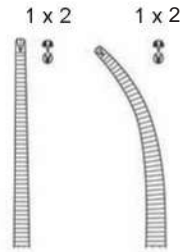



14,0 cm, 5 1/2"	HS-1617-14	HS-1618-14
16,0 cm, 6 1/4"	HS-1617-16	HS-1618-16
18,0 cm, 7"	HS-1617-18	HS-1618-18
20,0 cm, 8"	HS-1617-20	HS-1618-20
22,0 cm, 8 5/8"	HS-1617-22	HS-1618-22
24,0 cm, 9 1/2"	HS-1617-24	HS-1618-24
26,0 cm, 10 1/4"	HS-1617-26	HS-1618-26
30,0 cm, 12"	HS-1617-30	HS-1618-30

ROCHESTER-PEAN

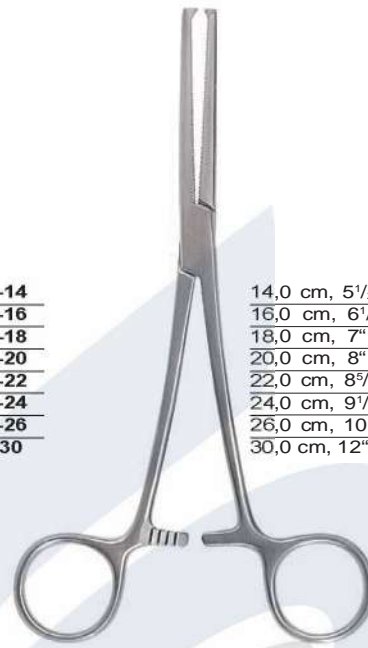

14,0 cm, 5 1/2"	HS-1619-14	HS-1620-14
16,0 cm, 6 1/4"	HS-1619-16	HS-1620-16
18,0 cm, 7"	HS-1619-18	HS-1620-18
20,0 cm, 8"	HS-1619-20	HS-1620-20
22,0 cm, 8 5/8"	HS-1619-22	HS-1620-22
24,0 cm, 9 1/2"	HS-1619-24	HS-1620-24
26,0 cm, 10 1/4"	HS-1619-26	HS-1620-26
30,0 cm, 12"	HS-1619-30	HS-1620-30

KOCHER-OCHSNER



20,0 cm, 8"	HS-1621-20	HS-1622-20	HS-1623-20	HS-1624-20
26,0 cm, 10 1/4"	HS-1621-26	HS-1622-26	HS-1623-26	HS-1624-26

BENGOLEA

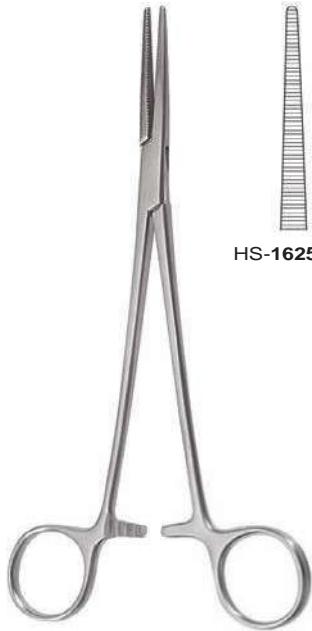

HEISS
20,0 cm, 8"

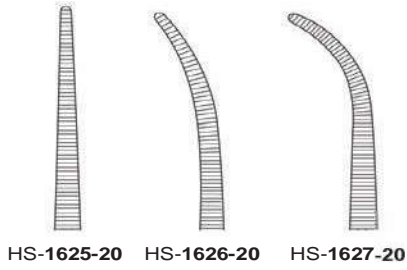

ROBERTS
22,0 cm, 8⁵/₈"

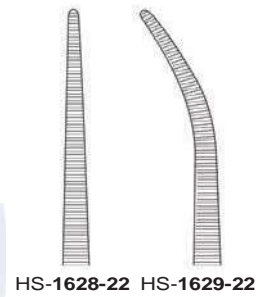

SAROT
24,0 cm, 9¹/₂"

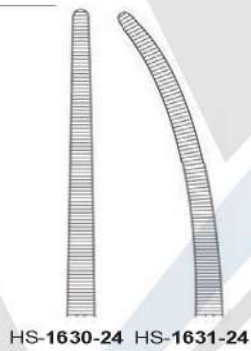

NEGUS
19,0 cm, 7¹/₂"

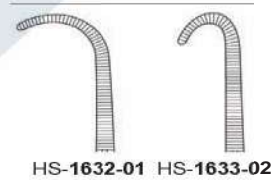



14,0 cm, 5 1/2" HS-1634-14
18,0 cm, 7" HS-1635-18

BABY-ADSON



MICRO-ADSON
14,0 cm, 5 1/2"
HS-1636-14



BABY-MIXTER
18,0 cm, 7"
HS-1637-18



OVERHOLT-MIXTER
21,0 cm, 8 1/4"
HS-1638-21



JOHNS HOPKINS
20,0 cm, 8"
HS-1639-20



HAGGAI

S U R G I C A L

Präparier- und Ligaturklemmen
Dissecting and Ligature Forceps
Pinzas de disección y ligaduras
Pinze per preparazioni e legature



OVERHOLT

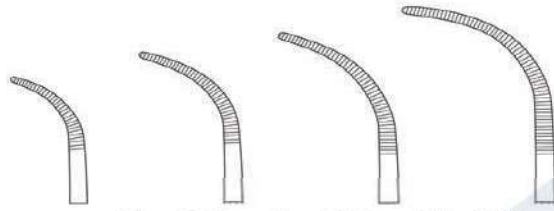

18,5 cm, 7 1/4"
HS-1640-01

20,0 cm, 8"
HS-1640-02

21,0 cm, 8 1/4"
HS-1640-03

21,5 cm, 8 1/2"
HS-1640-04



RUMEL
23,0 cm, 9"

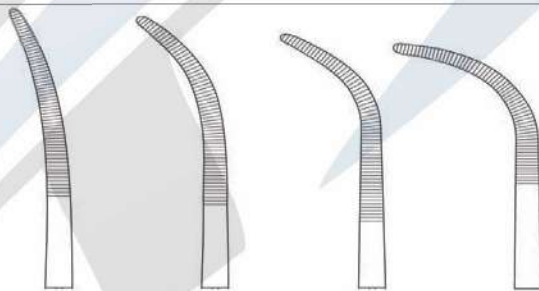

HS-1641-01

HS-1641-02

HS-1641-03

-1641-04



OVERHOLT-GEISSENDOERFER

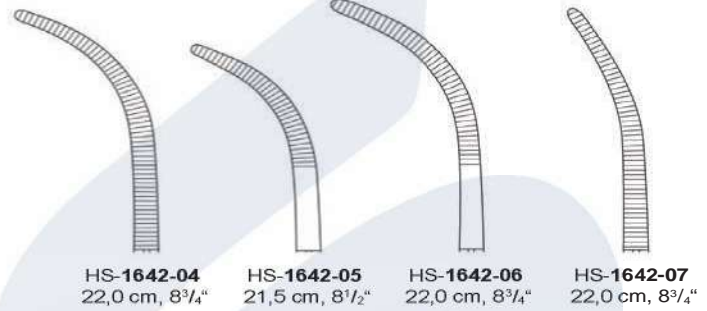
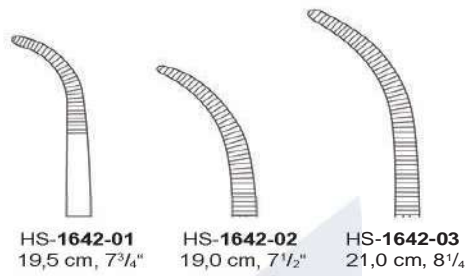

OVERHOLT-GEISSENDOERFER

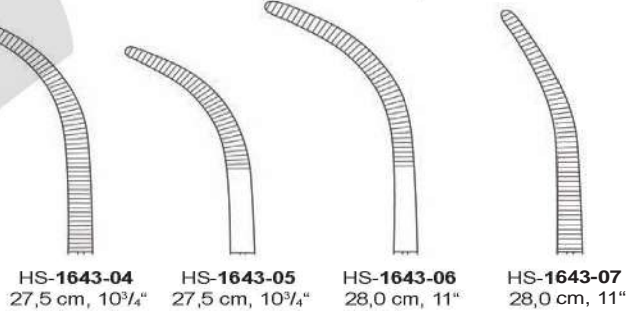
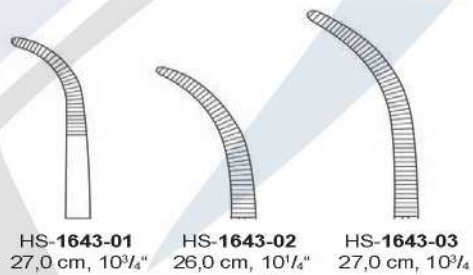



HAGGAI

S U R G I C A L

Präparier- und Ligaturklemmen
Dissecting and Ligature Forceps
Pinzas de disección y ligaduras
Pinze per preparazioni e legature



TOENNIS

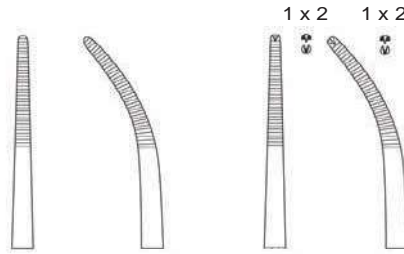

21,0 cm, 8 ¹ / ₄ "	HS-1644-21	HS-1645-21	HS-1646-21	HS-1647-21
26,0 cm, 10 ¹ / ₄ "	HS-1644-26	HS-1645-26	HS-1646-26	HS-1647-26



KELLY

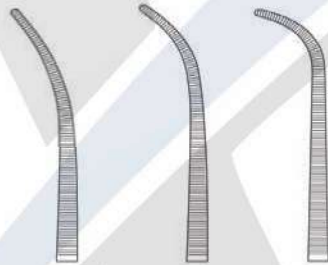

19,0 cm, 7 ¹ / ₂ "	HS-1648-19	HS-1649-19	HS-1650-19
22,0 cm, 8 ⁵ / ₈ "	HS-1648-22	HS-1649-22	HS-1650-22
24,0 cm, 9 ¹ / ₂ "	HS-1648-24	HS-1649-24	HS-1650-24



MINI-GEMINI

- 18,0 cm, 7" HS-1651-18
- 22,0 cm, 8⁵/₈" HS-1651-22
- 25,0 cm, 9³/₄" HS-1651-25
- 28,0 cm, 11" HS-1651-28



GEMINI

- 14,0 cm, 5¹/₂" HS-1652-14
- 16,0 cm, 6¹/₄" HS-1652-16
- 18,0 cm, 7" HS-1652-18
- 20,0 cm, 8" HS-1652-20
- 23,0 cm, 9" HS-1652-23
- 25,0 cm, 9³/₄" HS-1652-25
- 28,0 cm, 11" HS-1652-28



KANTROWITZ

- 20,0 cm, 8" HS-1653-20
- 24,0 cm, 9¹/₂" HS-1653-24
- 28,0 cm, 11" HS-1653-28



WIKSTROEM

- 19,0 cm, 7¹/₂" HS-1654-19
- 21,0 cm, 8¹/₄" HS-1654-21
- 24,0 cm, 9¹/₂" HS-1654-24



MIXTER

15,5 cm, 6" HS-1655-15
19,0 cm, 7½" HS-1655-19



MIXTER-O'SHAUGNESSY

15,5 cm, 6" HS-1656-15
19,0 cm, 7½" HS-1656-19



MIXTER

22,0 cm, 8¾" HS-1657-22



MIXTER

23,0 cm, 9" HF-1473-23



ZENKER



HS-1658-01 HS-1659-02



ZENKER

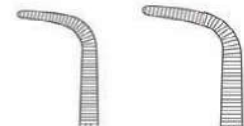

HS-1660-18 HS-1661-28



LAWRENCE
27,5 cm, 10³/₄"
HS-1664-28



HOSEMANN
21,0 cm, 8¹/₄"



DESJARDINS
21,0 cm, 8¹/₄"
HS-1665-21

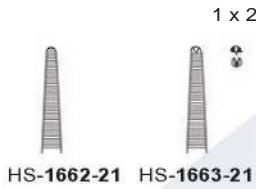

HS-1662-21 HS-1663-21

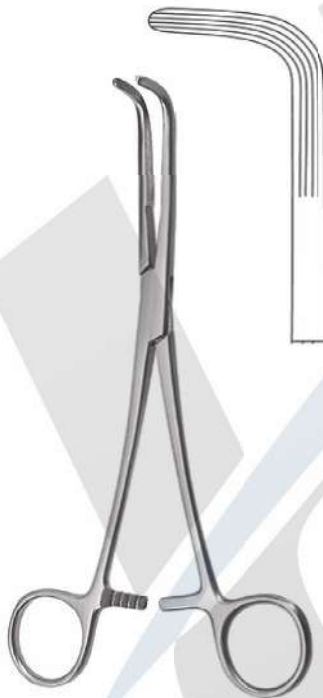

MIXER
22,0 cm, 8³/₄" HS-1666-22
25,0 cm, 9³/₄" HS-1666-25
28,0 cm, 11" HS-1666-28



LAHEY
19,0 cm, 7¹/₂" HS-1667-19
23,0 cm, 9" HS-1667-23



LOWER
18,0 cm, 7"
HS-1668-18



MC QUIGG-MIXTER
22,0 cm, 8³/₄"
HS-1671-22

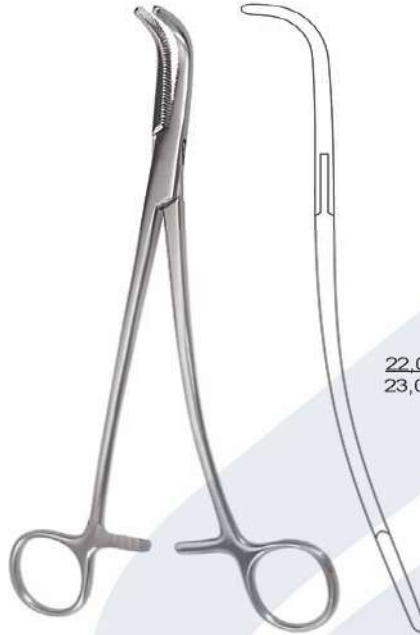

GRAY

22,0 cm, 8³/₄" HS-1669-22 HS-1670-22
23,0 cm, 9" HS-1669-23 HS-1670-23

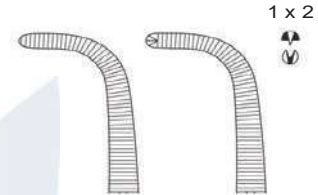

1 x 2
↕



CRAFOORD-SELLORS

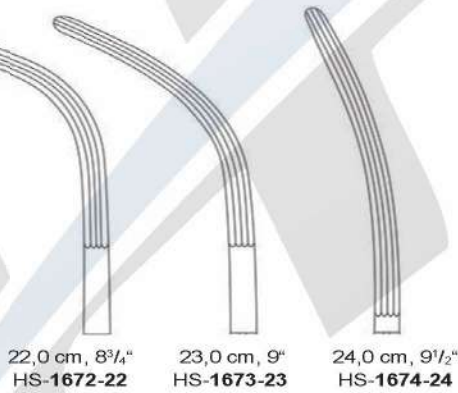

22,0 cm, 8³/₄" HS-1672-22
23,0 cm, 9" HS-1673-23
24,0 cm, 9¹/₂" HS-1674-24



FINOCCHIETTO
24,0 cm, 9¹/₂"
HS-1675-24



GUYON

20,0 cm, 8"	HS-1676-20
22,0 cm, 8 ³ / ₄ "	HS-1676-22
24,0 cm, 9 ¹ / ₂ "	HS-1676-24

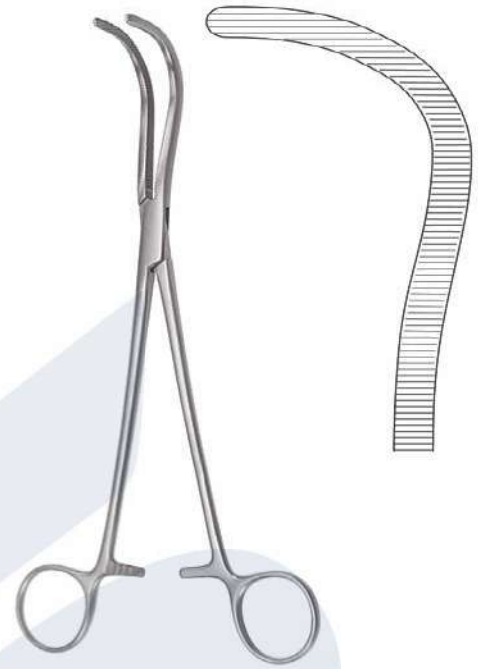

GUYON

23,0 cm, 9"	HS-1677-23
-------------	------------



GUYON



23,0 cm, 9"
HS-1678-23



24,0 cm, 9¹/₂"
HS-1679-24



STILLE

23,0 cm, 9"	HS-1680-23
-------------	------------



HERRICK
23,0 cm, 9"
HS-1681-23



URO-TANGENTIAL
26,0 cm, 10¹/₄"

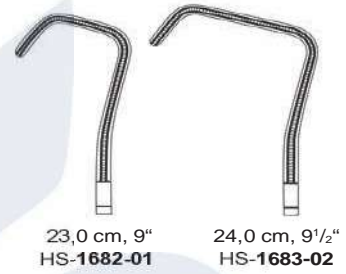

23,0 cm, 9"
HS-1682-01

24,0 cm, 9¹/₂"
HS-1683-02



LOVELACE
20,0 cm, 8"
HS-1684-20

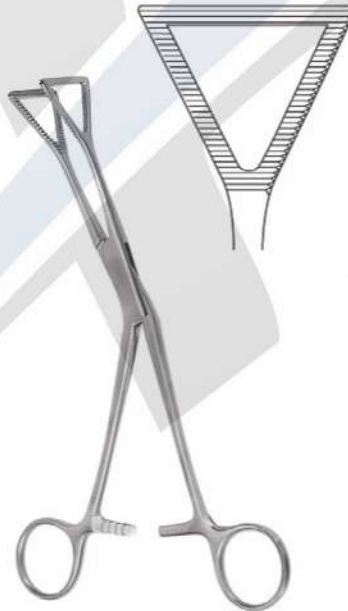

LOVELACE
20,0 cm, 8"
HS-1685-20



PRICE-THOMAS
22,0 cm, 8³/₄"
HS-1686-22



HAGGAI

S U R G I C A L

Bronchusklemmen, Peritoneumklemmen, Hysterektomieklemmen
 Bronchus Forceps, Peritoeum Forceps, Hysterectomy Forceps
 Pinzas-clamps para bronquios, Pinzas-clamps para peritoneo y para histerectomia
 Pinze per legature, Pinze per peritoneo e per isterectomia



PRICE-THOMAS
22,0 cm, 8³/₄"



HS-1687-01

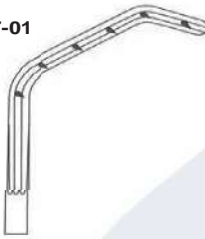

HS-1688-02



SEMB
24,0 cm, 9¹/₂"



HS-1689-01



HS-1690-02



BABY-MIKULICZ
14,0 cm, 5¹/₂"
HS-1691-14



1 x 2



MIKULICZ
18,0 cm, 7"
HS-1692-18



1 x 2



MIKULICZ
20,0 cm, 8"
HS-1693-20

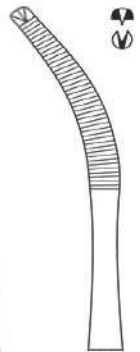

1 x 2



HAGGAI

S U R G I C A L

Peritoneumklemmen, Hysterektomieklemmen
Peritoneum Forceps, Hysterectomy Forceps
Pinzas-clamps para peritoneo y para histerectomía
Pinze per peritoneo e per isterectomia



FAURE
20,0 cm, 8"

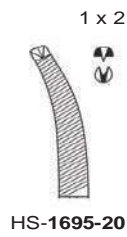
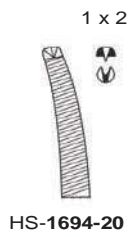

PHANEUF
21,5 cm, 8 1/2"

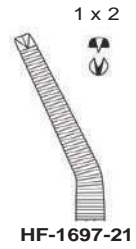

WERTHEIM
24,0 cm, 9 1/2"
HF-1698-24

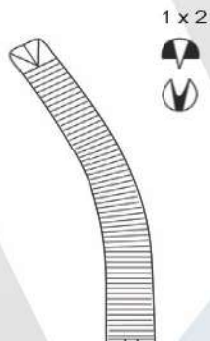

WERTHEIM
25,0 cm, 10"
HF-1699-25





WERTHEIM
23,0 cm, 9"

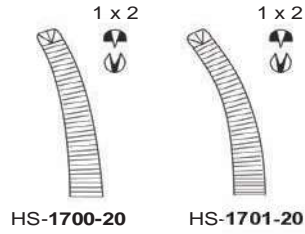

MAINGOT
21,5 cm, 8 1/2"

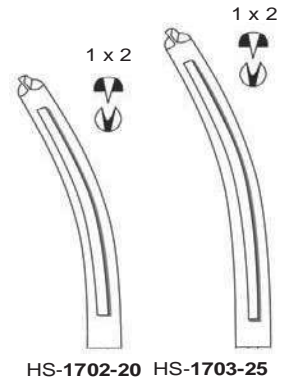

MOYNIHAN

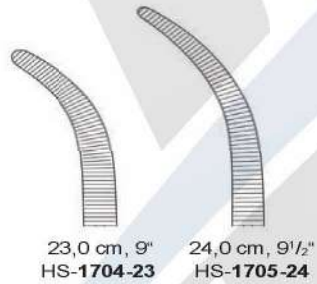

WERTHEIM-CULLEN
21,5 cm, 8 1/2"
HS-1706-21



S U R G I C A L

1x2

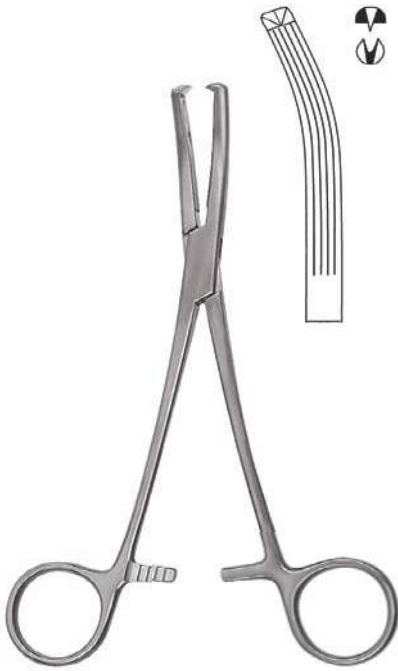

LONG
19,0 cm, 7 1/4"
HS-1707-19

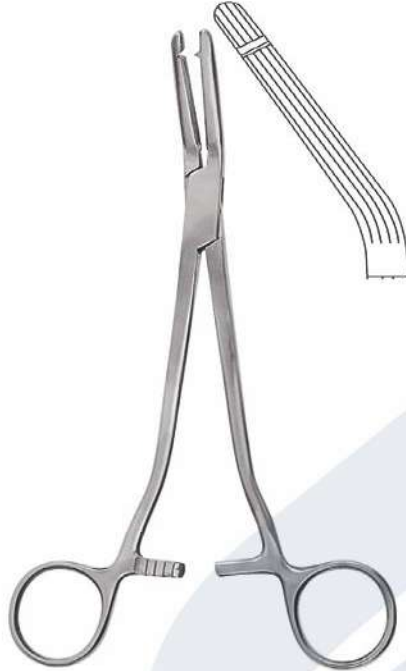

GARLAND
21,0 cm, 8 1/4"
HS-1708-21

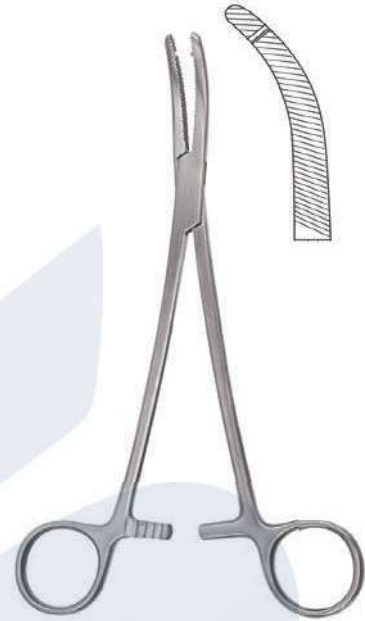

HEANEY
21,0 cm, 8 1/4"
HS-1709-21



HEANEY-BALLANTINE
21,0 cm, 8 1/4"



HS-1710-21



HS-1711-21



HEANEY-KANTER
21,0 cm, 8 1/4"
HS-1712-21

Hysterektomieklemmen
Hysterectomy Forceps
Pinzas-clamps para histerectomía
Pinze per isterectomia



HEANEY

21,0 cm, 8¹/₄" HS-1713-21 HS-1714-21
23,0 cm, 9" HS-1713-23 HS-1714-23



HAGGAI

S U R G I C A L

Nahtinstrumente

Suture Instruments

Instrumentos para sutura

Strumenti per sutura





DERF

HS-1715-12
12,0 cm, 4³/₄"



HS-1716-12
12,5 cm, 5"



COLLIER
12,5 cm, 5"
HS-1717-12



WEBSTER
13,0 cm, 5"
HS-1718-13



HALSEY
13,0 cm, 5"

HS-1719-13 HS-1720-13



NEIVERT
13,0 cm, 5"
HS-1721-13



HEGAR-BAUMGARTNER
14,0 cm, 5¹/₂"
HS-1722-14





HS-1723-13
13,0 cm, 5"



BROWN



CRILE-MURRAY
15,0 cm, 6"
HS-1725-15



HS-1724-15
15,0 cm, 6"



CRILE-WOOD



ADSON
18,0 cm, 7"
HS-1726-18



METZENBAUM
18,0 cm, 7"
HS-1727-18



MASS.-GENERAL-HOSPITAL
17,0 cm, 6³/₄"
HS-1728-17



HS-1729-14

HS-1729-16

HS-1729-18

HS-1729-20

HS-1729-24

HS-1729-26

HS-1729-30

MAYO-HEGAR



HS-1730-16
16,0 cm, 6 1/4"

HS-1730-18
18,0 cm, 7"

HS-1730-20
20,0 cm, 8"

MAYO-HEGAR-DELICATE



LAWRENCE
15,0 cm, 6"
HS-1731-15



HEANEY
21,0 cm, 8¹/₄"
HS-1732-21



JAMISON
23,5 cm, 9¹/₄"
HS-1733-23



MASSON
27,0 cm, 10¹/₂"
HS-1734-27



FINOCCHIETTO
27,0 cm, 10¹/₂"
HS-1735-27



WANGENSTEEN
27,0 cm, 10¹/₂"
HS-1736-27

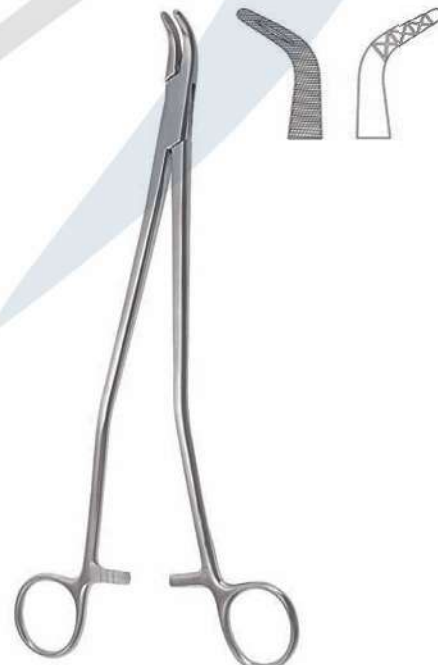

JOHNSON
27,0 cm, 10¹/₂"
HS-1737-27

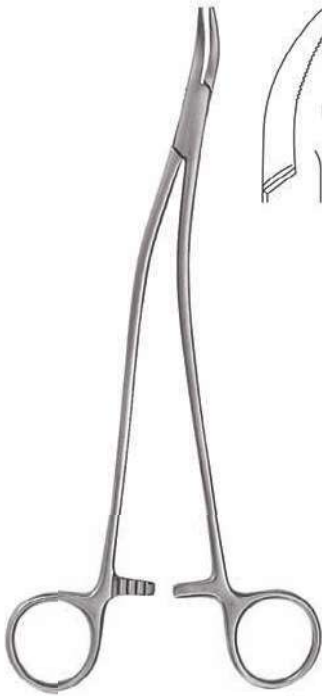

STRATTE
23,0 cm, 9"
HS-1738-23



OLSEN-HEGAR
17,0 cm, 6³/₄"
HS-1739-17

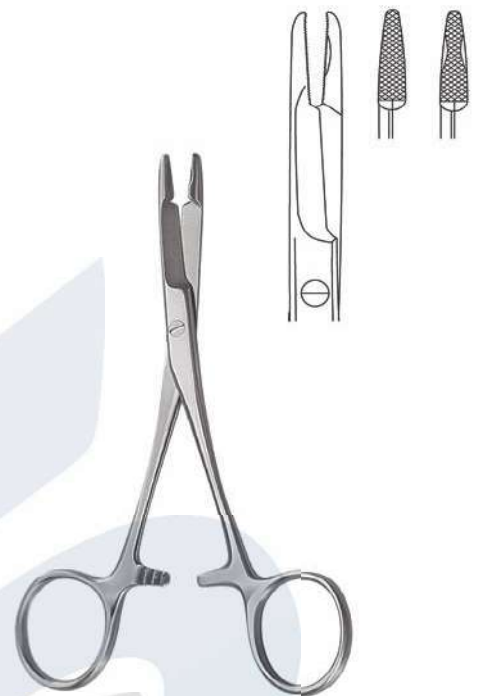

OLSEN-HEGAR
14,0 cm, 5¹/₂"
HS-1740-14



OLSEN-HEGAR

14,0 cm, 5¹/₂"
HS-1741-14



18,0 cm, 7"
HS-1741-18



TOENNIS
18,0 cm, 7"
HS-1742-18



MATHIEU



HS-1743-14
14,0 cm, 5½"



HS-1743-17
17,0 cm, 6¾"



HS-1743-20
20,0 cm, 8"



MATHIEU



HS-1744-17
17,0 cm, 6¾"



HS-1744-20
20,0 cm, 8"



LICHTENBERG
20,0 cm, 8"
HS-1746-20



MATHIEU



HS-1745-14
14,0 cm, 5½"



HS-1745-17
17,0 cm, 6¾"



MATHIEU-KOCHER



HS-1747-14
14,0 cm, 5 1/2"



HS-1747-17
17,0 cm, 6 3/4"



HS-1747-20
20,0 cm, 8"



BARRAQUER-TROUTMAN
10,0 cm, 4"



HS-1748-10



HS-1749-10



BARRAQUER



HS-1750-10



HS-1751-10



BARRAQUER
13,5 cm, 5 3/8"
HS-1752-13



GOMEL
14,0 cm, 5 1/2"
HS-1753-14

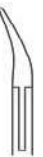



HS-1754-18 HS-1755-18

ohne Sperre
without ratchet
sin cremallera
senza cremagliera

18,5 cm, 7¹/₄"



HS-1757-18 HS-1758-18

mit Sperre
with ratchet
con cremallera
con cremagliera

18,5 cm, 7¹/₄"



HS-1759-14 HS-1760-14

mit Sperre
with ratchet
con cremallera
con cremagliera

CASTROVIEJO
14,5 cm, 5³/₄"



HS-1763-18 HS-1764-18



HS-1765-18 HS-1766-18

mit Sperre
with ratchet
con cremallera
con cremagliera

CASTROVIEJO
18,0 cm, 7"



0,4 mm



gerade, ohne Sperre
straight, without ratchet
recta, sin cremallera
retta, senza cremagliera

14,0 cm, 5 1/2"
HS-1767-14

0,4 mm



gebogen, ohne Sperre
curved, without ratchet
curva, sin cremallera
curva, senza cremagliera

14,0 cm, 5 1/2"
HS-1768-14

0,4 mm



14,0 cm, 5 1/2"
HS-1769-14

0,5 mm



gebogen, ohne Sperre
curved, without ratchet
curva, sin cremallera
curva, senza cremagliera

14,0 cm, 5 1/2"
HS-1770-14

Ø 10 mm

0,5 mm



gebogen, ohne Sperre
curved, without ratchet
curva, sin cremallera
curva, senza cremagliera

14,0 cm, 5 1/2"
HS-1771-14

Ø 10 mm

0,4 mm



gebogen, ohne Sperre
curved, without ratchet
curva, sin cremallera
curva, senza cremagliera

13,0 cm, 5"
HS-1772-13

Ø 8 mm

0,4 mm



gebogen, ohne Sperre
curved, without ratchet
curva, sin cremallera
curva, senza cremagliera

13,0 cm, 5"
HS-1773-13

Ø 8 mm



HAGGAI

S U R G I C A L

Nadelhalter mit Hartmetalleinlagen
Needle Holders with tungsten carbide inserts
Porta-agujas con bocas de carburo tungsteno
Portaghi con morsi in carburo di tungsteno



KALT
13,5 cm, 5³/₈"
HS-1776-14



- | | |
|---|------------|
| 16,0 cm, 5 ³ / ₈ " | HS-1775-16 |
| 18,0 cm, 7" | HS-1775-18 |
| 20,0 cm, 8" | HS-1775-20 |
| 23,0 cm, 9" | HS-1775-23 |
| 26,0 cm, 10 ¹ / ₄ " | HS-1775-26 |

DIETHRICH



WEBSTER
13,0 cm, 5"
HS-1777-13



DERF
12,0 cm, 4³/₄"
HS-1780-12



HS-1778-12
12,5 cm, 5"

HEGAR-BAUMGARTNER



HS-1779-14
14,0 cm, 5¹/₂"



WEBSTER
13,0 cm, 5"
HS-1781-13



HAGGAI

S U R G I C A L

Nadelhalter mit Hartmetalleinlagen
Needle Holders with tungsten carbide inserts
Porta-agujas con bocas de carburo tungsteno
Portaghi con morsi in carburo di tungsteno



HALSEY
13,0 cm, 5"



HS-1782-13



HS-1783-13



CRILE-WOOD



HS-1784-15
15,0 cm, 6"



HS-1784-18
18,0 cm, 7"



SAROT



HS-1785-18
18,0 cm, 7"



HS-1785-20
20,0 cm, 8"



HS-1785-26
26,0 cm, 10 1/4"



HAGGAI

S U R G I C A L

Nadelhalter mit Hartmetalleinlagen
Needle Holders with tungsten carbide inserts
Porta-agujas con bocas de carburo tungsteno
Portaghi con morsi in carburo di tungsteno



MAYO-HEGAR

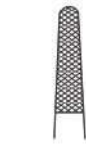

HS-1786-16
16,0 cm, 6¹/₄"



HS-1786-18
18,0 cm, 7"



HS-1786-20
20,0 cm, 8"



HS-1786-24
24,0 cm, 9¹/₂"



HS-1786-26
26,0 cm, 10¹/₄"



HS-1786-30
30,0 cm, 12"



MAYO-HEGAR (HEANEY)



HS-1787-20
20,0 cm, 8"



HS-1787-24
24,0 cm, 9¹/₄"



HS-1787-26
26,0 cm, 10¹/₄"



HAGGAI

S U R G I C A L

Nadelhalter mit Hartmetalleinlagen
Needle Holders with tungsten carbide inserts
Porta-agujas con bocas de carburo tungsteno
Portaghi con morsi in carburo di tungsteno



DE BAKEY



HS-1788-18
18,0 cm, 7"



HS-1788-20
20,0 cm, 8"



HS-1788-23
23,0 cm, 9"



HS-1788-26
26,0 cm, 10 1/4"



AKTC-1788-31
31,0 cm, 12 1/4"



HS-1788-37
37,0 cm, 14 1/2"

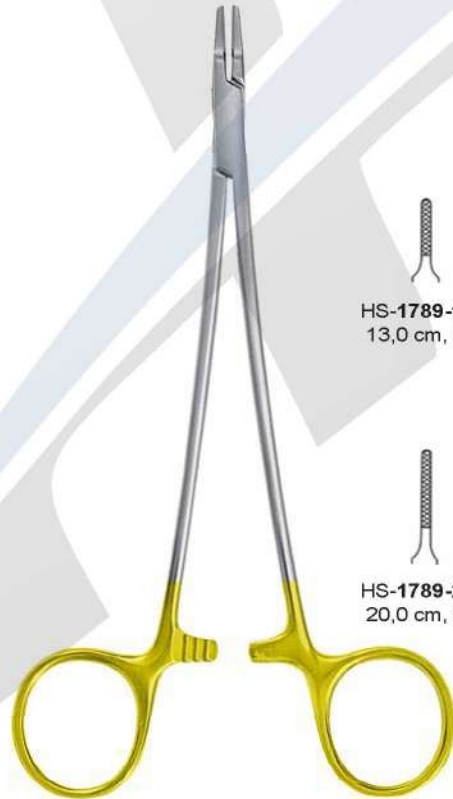

RYDER-VASCULAR



HS-1789-13
13,0 cm, 5"



HS-1789-15
15,0 cm, 6"



HS-1789-18
18,0 cm, 7"

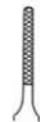

HS-1789-20
20,0 cm, 8"



HS-1789-23
23,0 cm, 9"



HS-1789-26
26,0 cm, 10 1/4"



HAGGAI

S U R G I C A L

Nadelhalter mit Hartmetalleinlagen
Needle Holders with tungsten carbide inserts
Porta-agujas con bocas de carburo tungsteno
Portaghi con morsi in carburo di tungsteno

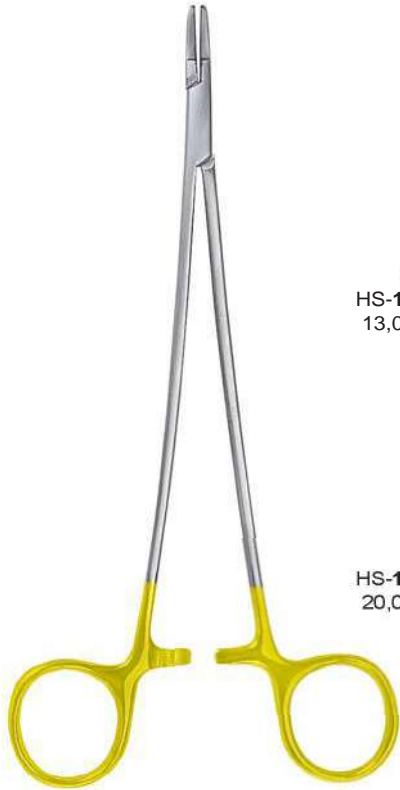

RYDER



HS-1790-13
13,0 cm, 5"

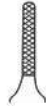

HS-1790-15
15,0 cm, 6"



HS-1790-18
18,0 cm, 7"



HS-1790-20
20,0 cm, 8"

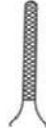

HS-1790-23
23,0 cm, 9"



HS-1790-26
26,0 cm, 10¹/₄"



SCHWEDISCHES MODELL



HS-1791-15
15,0 cm, 6"



HS-1791-17
17,0 cm, 6³/₄"



HS-1791-20
20,0 cm, 8"



HAGGAI

S U R G I C A L

Nadelhalter mit Hartmetalleinlagen
Needle Holders with tungsten carbide inserts
Porta-agujas con bocas de carburo tungsteno
Portaghi con morsi in carburo di tungsteno

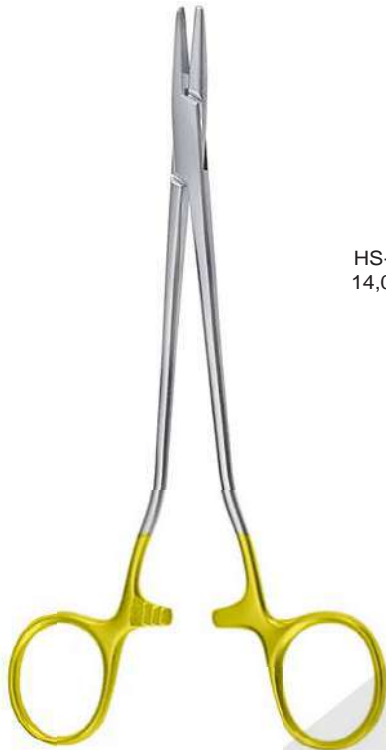

MAYO-HEGAR (HEANEY)



HS-1792-14
14,0 cm, 5½"



HS-1792-18
18,0 cm, 7"



HS-1792-20
20,0 cm, 8"



HS-1792-23
23,0 cm, 9"



FINOCCHIETTO
27,0 cm, 10½"
HS-1793-27



MASSON
27,0 cm, 10½"
HS-1794-27



WANGENSTEEN
27,0 cm, 10½"
HS-1795-27



BOZEMANN

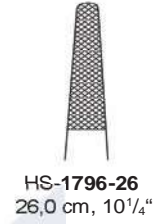

HEGAR



BARRY STERNAL





S U R G I C A L



STRATTE



HS-1799-22
22,0 cm, 8⁵/₈"



HS-1799-23
23,0 cm, 9"



GILLIES
16,0 cm, 6¹/₄"
HS-1800-16

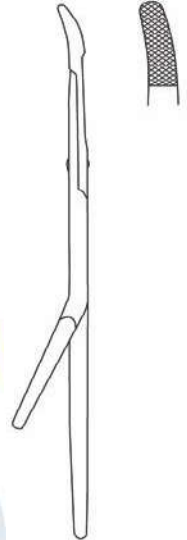

OLSEN-HEGAR



HS-1801-14
14,0 cm, 5¹/₂"



HS-1801-17
17,0 cm, 6³/₄"



HS-1801-18
18,0 cm, 7"



TOENNIS
18,0 cm, 7"
HS-1802-18



HAGGAI

S U R G I C A L

Nadelhalter mit Hartmetalleinlagen
Needle Holders with tungsten carbide inserts
Porta-agujas con bocas de carburo tungsteno
Portaghi con morsi in carburo di tungsteno



MATHIEU-KOCHER



HS-1803-14
14,0 cm, 5½"



HS-1803-17
17,0 cm, 6¾"



HS-1803-20
20,0 cm, 8"



MATHIEU



HS-1804-14
14,0 cm, 5½"



HS-1804-17
17,0 cm, 6¾"



HS-1804-20
20,0 cm, 8"



HAGGAI

S U R G I C A L

Nadelhalter mit Hartmetalleinlagen
Needle Holders with tungsten carbide inserts
Porta-agujas con bocas de carburo tungsteno
Portaghi con morsi in carburo di tungsteno



LICHTENBERG



HS-1805-17
17,0 cm, 6³/₄"



HS-1805-20
20,0 cm, 8"



MATHIEU



HS-1806-17
17,0 cm, 6³/₄"



HS-1806-20
20,0 cm, 8"



HS-1806-23
23,0 cm, 9"



HAGGAI

S U R G I C A L

Nadelhalter mit Hartmetalleinlagen
Needle Holders with tungsten carbide inserts
Porta-agujas con bocas de carburo tungsteno
Portaghi con morsi in carburo di tungsteno



ZWEIFEL



HS-1807-20
20,0 cm, 8"



HS-1807-23
23,0 cm, 9"



LANGENBECK



HS-1808-18
18,0 cm, 7"



HS-1808-20
20,0 cm, 8"



HS-1808-23
23,0 cm, 9"



HS-1809-18
18,0 cm, 7"



HS-1809-20
20,0 cm, 8"



HS-1809-23
23,0 cm, 9"



HAGGAI

S U R G I C A L

Nadelhalter mit Hartmetalleinlagen
Needle Holders with tungsten carbide inserts
Porta-agujas con bocas de carburo tungsteno
Portaghi con morsi in carburo di tungsteno



CASTROVIEJO
14,5 cm, 5³/₄"



HS-1810-14



HS-1810-14



HS-1810-14



HS-1810-14

mit Sperre
with ratchet
con cremallera
con cremagliera



CASTROVIEJO
18,0 cm, 7"



HS-1811-18



HS-1812-18



HS-1813-18



HS-1814-18

mit Sperre
with ratchet
con cremallera
con cremagliera



BARRAQUER
14,5 cm, 5³/₄"



HS-1815-14



HS-1816-14



HS-1817-14



HS-1818-14

mit Sperre
with ratchet
con cremallera
con cremagliera



HEPP SCHEIDEL
18,0 cm, 7"
HS-1819-18





REVERDIN
 14,0 cm, 5 1/2"

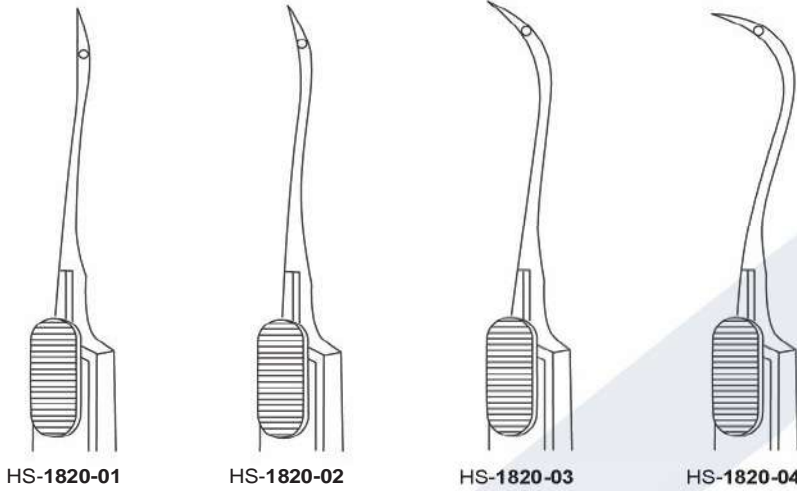

HS-1820-01

HS-1820-02

HS-1820-03

HS-1820-04



REVERDIN

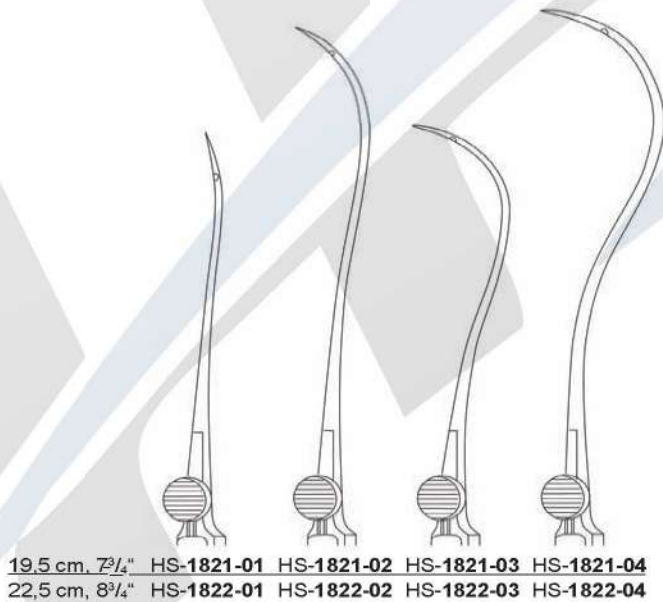

19,5 cm, 7 3/4" HS-1821-01 HS-1821-02 HS-1821-03 HS-1821-04
 22,5 cm, 8 3/4" HS-1822-01 HS-1822-02 HS-1822-03 HS-1822-04

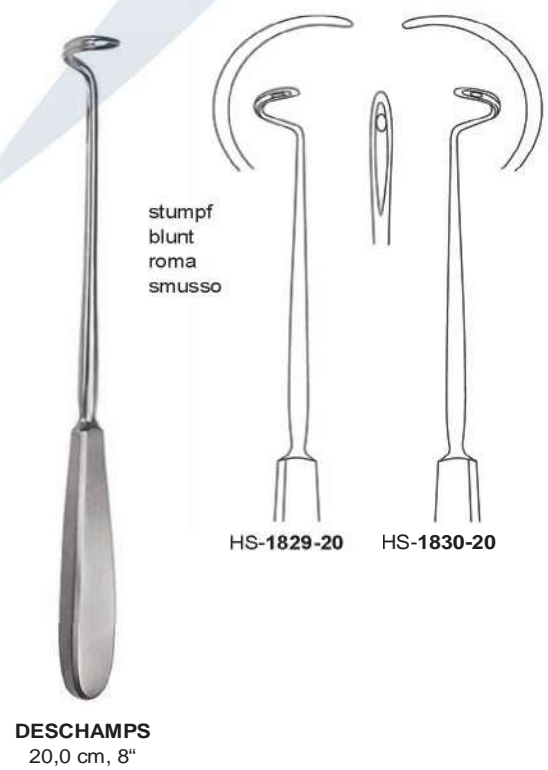
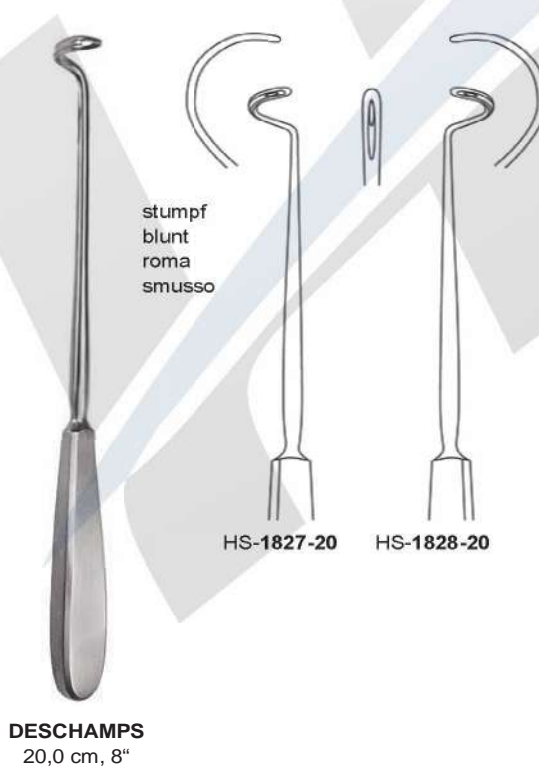
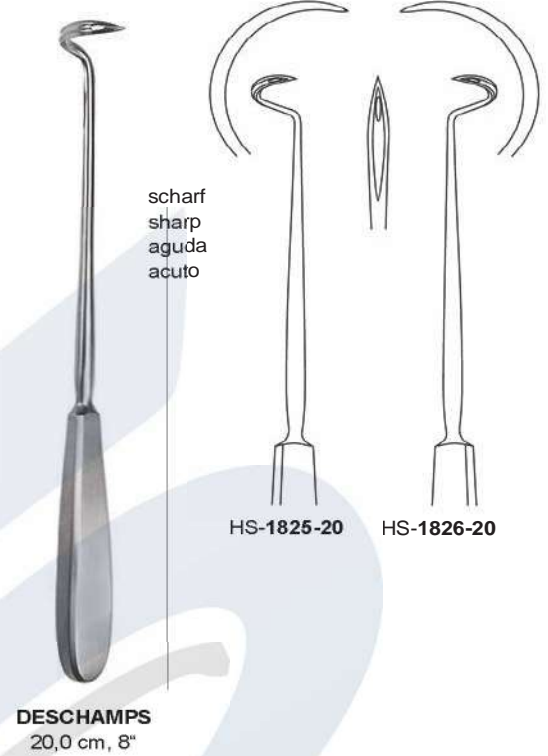

S U R G I C A L



scharf
sharp
aguda
acuto

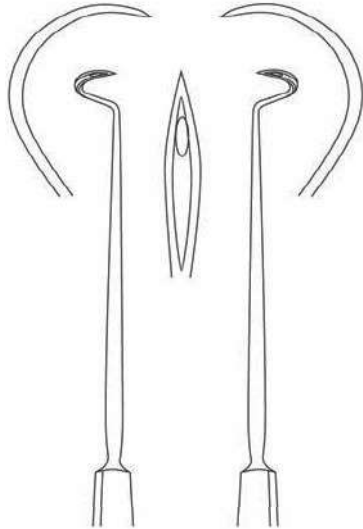

21,0 cm, 8¹/₄" HS-1831-21 HS-1832-21
27,0 cm, 10⁵/₈" HS-1831-27 HS-1832-27

DESCHAMPS



stumpf
blunt
roma
smusso

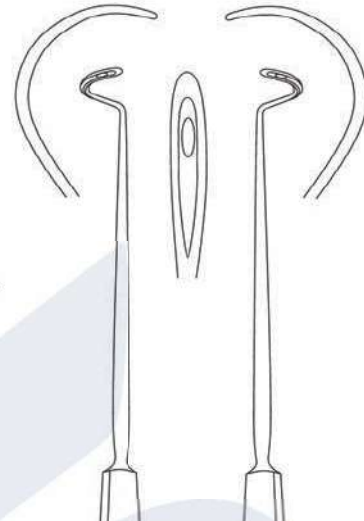

21,0 cm, 8¹/₄" HS-1833-21 HS-1834-21
27,0 cm, 10⁵/₈" HS-1833-27 HS-1834-27

DESCHAMPS



biegsam
malleable
maleable
malleabile

20,0 cm, 8"
HS-1835-20



COOPER
19,0 cm, 7¹/₂"
HS-1836-19



COOPER
20,0 cm, 8"
HS-1837-20



SYME
15,0 cm, 6"
HS-1838-15



KOCHER
19,0 cm, 7¹/₂"



HS-1839-01



HS-1839-02



HS-1839-03



BRUNNER
25,0 cm, 9³/₄"
HS-1840-25



BRUNNER
30,0 cm, 11³/₄"



HS-1841-01



HS-1841-02



SCHMIEDEN
21,0 cm, 8¹/₄"
HS-1842-21



YOUNG-HRYNTSCHAK
24,0 cm, 9 1/2"
LN-1844-24



HS-1843-01

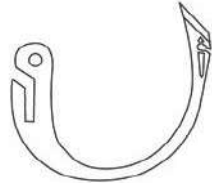

HS-1843-02

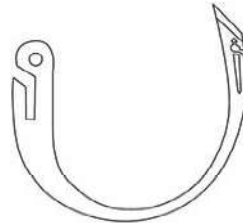

HS-1843-03



DE LA ROZA
12,0 cm, 4 3/4"
HS-1845-01



DE LA ROZA
12,0 cm, 4 3/4"
HS-1846-02



JAKOBI
14,0 cm, 5 1/2"
HS-1847-14



HESSEBERG
15,0 cm, 6"
HS-1848-15



KRONECKER
15,0 cm, 6"
HS-1849-01



KRONECKER
15,0 cm, 6"
HS-1850-02



TRÉLAT
23,0 cm, 9"
HS-1851-23



CLAUS
23,0 cm, 9"
HS-1852-23



HURD
21,0 cm, 8 1/4"
HS-1853-01



HURD
21,0 cm, 8 1/4"
HS-1854-02



NAGER
24,0 cm, 9 1/2"
HS-1855-24



CLAUS-EICKEN
23,0 cm, 9"
HS-1856-23



FALK
24,0 cm, 9 1/2"
HS-1857-01



FALK
24,0 cm, 9 1/2"
HS-1858-02

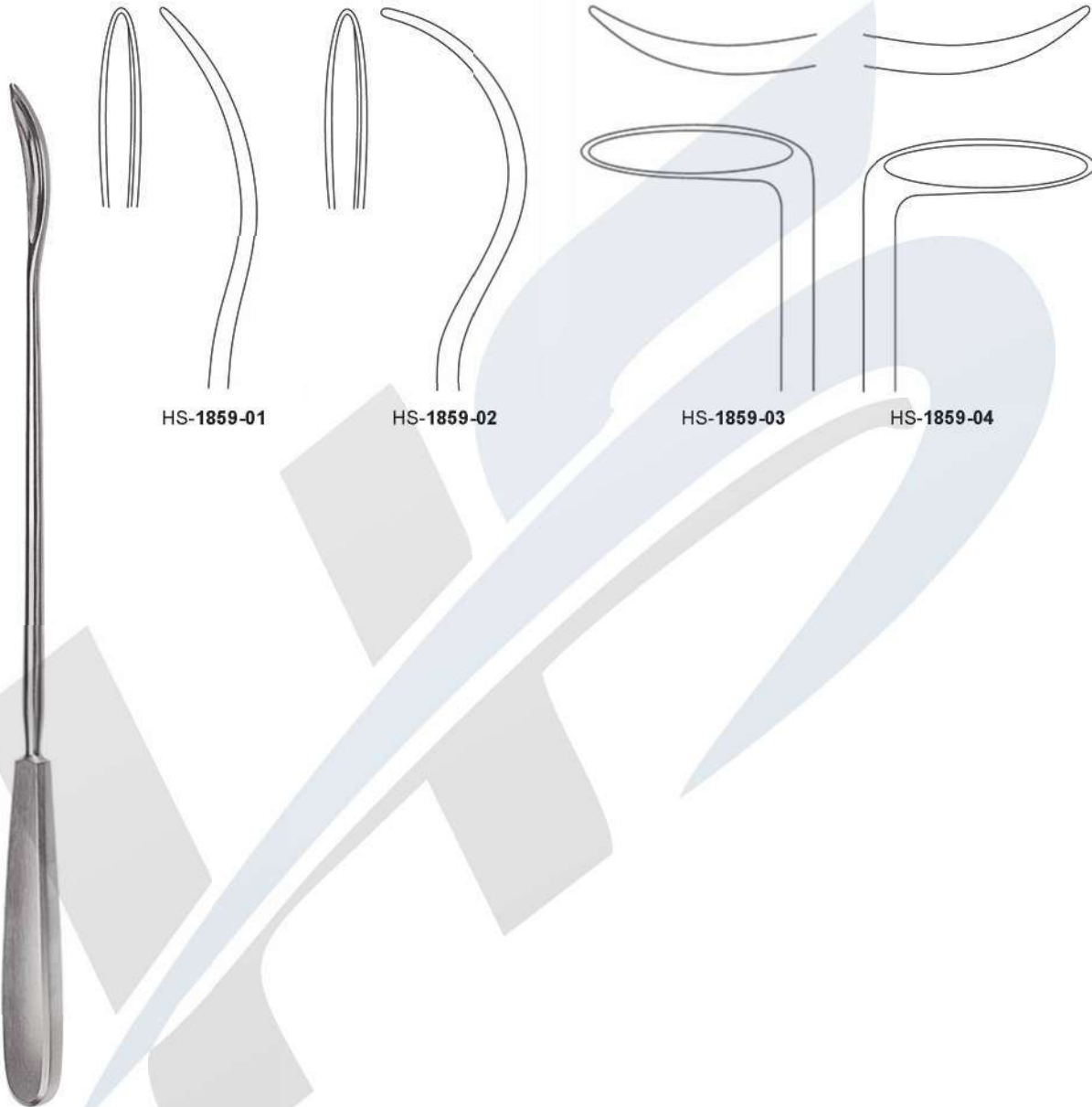

HS-1859-01

HS-1859-02

HS-1859-03

HS-1859-04

BRUNNER
30,0 cm, 11³/₄"



PAYR
22,0 cm, 8⁵/₈"
HS-1860-22



PAYR
22,0 cm, 8⁵/₈"
HS-1861-22



SCHMIEDEN-PAYR
19,0 cm, 7¹/₂"
HS-1862-19



SCHMIEDEN
19,0 cm, 7¹/₂"
HS-1863-19



KÖNIG
19,5 cm, 7³/₄"
HS-1864-03



KÖNIG
19,5 cm, 7³/₄"
HS-1865-05



KÖNIG
19,5 cm, 7³/₄"
HS-1866-07

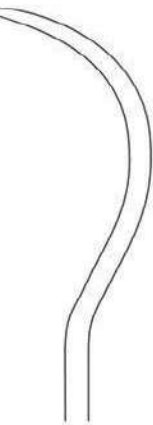

25,5 cm, 10"
 HS-1867-25

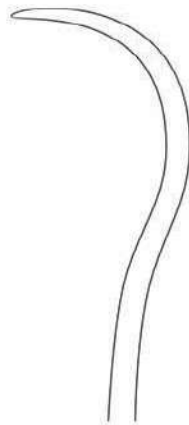

28,0 cm, 11"
 HS-1867-28

KIRSCHNER



BRUNNER-FERROZELL
 18,0 cm, 7" HS-1868-18
 27,0 cm, 10⁵/₈" HS-1868-27



KOCHER



15,0 cm, 6" HS-1869-15 LN-1870-15
 16,0 cm, 6¹/₄" HS-1869-16 LN-1870-16



18,0 cm, 7"
 HS-1871-18



MOD. WIEN
23,5 cm, 9¹/₄"
HS-1872-23



BOZEMANN
21,0 cm, 8¹/₄"
HS-1873-21



23,0 cm, 9"
HS-1874-23



MICHEL
12,0 cm, 4³/₄"
HS-1875-12



COLLIN
13,0 cm, 5"
HS-1876-13



RICHTER-HEATH
14,0 cm, 5¹/₂"
HS-1877-14



WACHENFELDT
12,5 cm, 5"
HS-1878-01



HEGENBARTH
12,5 cm, 5"
HS-1879-12



MICHEL
12,0 cm, 4 3/4"
HS-1880-12



LANGE
10,0 cm, 4"
HS-1881-10



CHILDE
18,0 cm, 7"
HS-1882-01



CHILDE
18,0 cm, 7"
HS-1883-02



- HS-1884-08 7,5 x 1,75 mm
- HS-1884-11 11,0 x 2,0 mm
- HS-1884-12 12,0 x 3,0 mm
- HS-1884-14 14,0 x 3,0 mm
- HS-1884-16 16,0 x 3,0 mm
- HS-1884-18 18,0 x 3,0 mm
- HS-1884-20 20,0 x 3,0 mm
- HS-1884-22 22,0 x 3,0 mm

MICHEL



CLIP-SET
056-558-00

bestehend aus, consisting of, compuesto de, composto da

- 1 x HS-1885-12
- 1 x HS-1886-12
- 50 x HS-1887-14

1 x HS-1888-01 (Etui)

Wundhaken
Retractors
Separadores
Divaricatori





GILLIES
 18,0 cm, 7"



Fig. 1
 HS-1889-01



Fig. 2
 HS-1890-02



KILNER
 15,0 cm, 6"
 HS-1891-15



FRAZIER
 13,0 cm, 5"
 HS-1892-13



O'CONNOR
 16,0 cm, 6 1/4"
 HS-1893-16



KLEINERT-KUTZ
 16,0 cm, 6 1/4"



Fig. 1
 HS-1894-01



Fig. 2
 HS-1895-02



Fig. 3
 HS-1895-03



JOSEPH
 16,0 cm, 6 1/4"
 HS-1898-16



GRAEFE
 16,0 cm, 6 1/4"



Fig. 1
 HS-1896-01



Fig. 2
 HS-1897-02



16,0 cm, 6 1/4"



Fig. 1
HS-1899-01



Fig. 2
HS-1900-02



Fig. 3
HS-1901-03



Fig. 4
HS-1902-04



GUTHRIE
16,0 cm, 6 1/4"



Fig. 1
HS-1903-01



Fig. 2
HS-1904-02



JOSEPH
16,0 cm, 6 1/4"



Fig. 1
HS-1905-01



Fig. 2
HS-1906-02



Fig. 3
HS-1907-03



Fig. 4
HS-1908-04

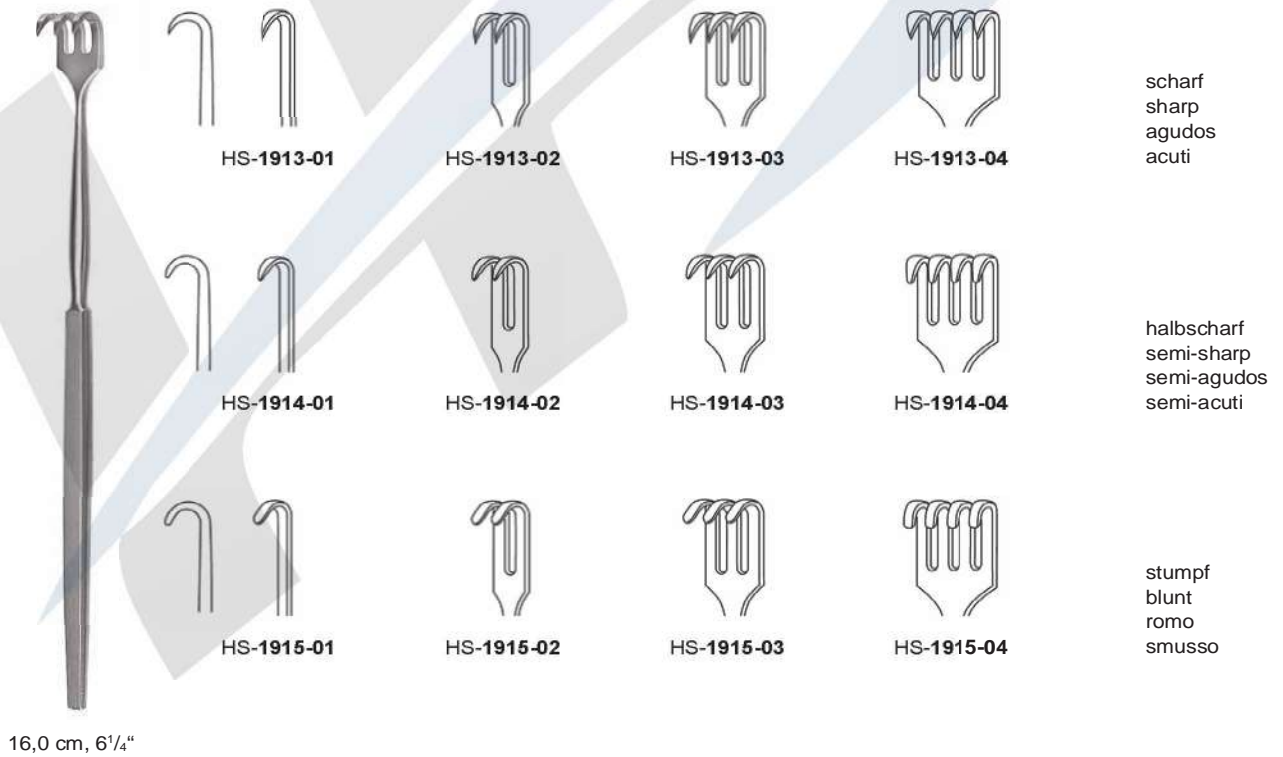
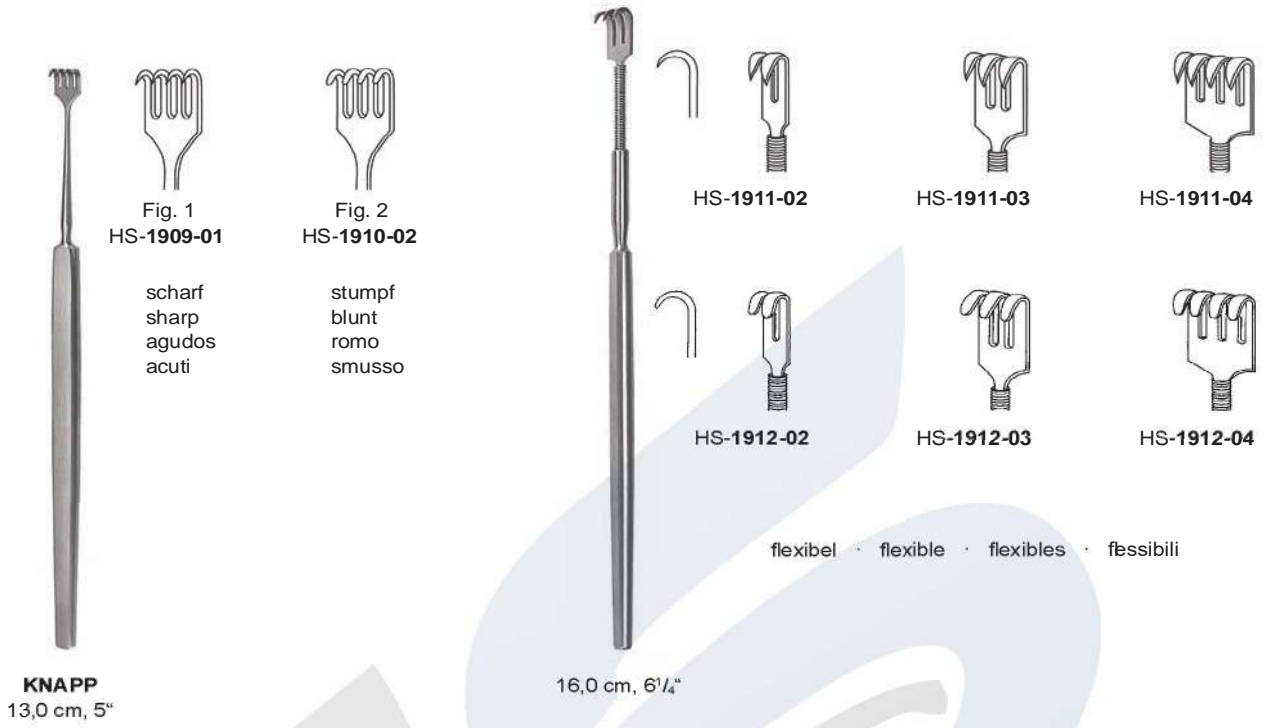

S U R G I C A L



16,0 cm, 6 1/4"



HS-1916-01



HS-1916-02



HS-1916-03

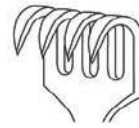

HS-1916-04

scharf
sharp
agudos
acuti



HS-1917-01



HS-1917-02

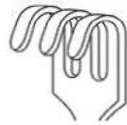

HS-1917-03



HS-1917-04

stumpf
blunt
romo
smusso



CUSHING
19,0 cm, 7 1/2"



Fig. 1
HS-1918-01



Fig. 2
HS-1918-02

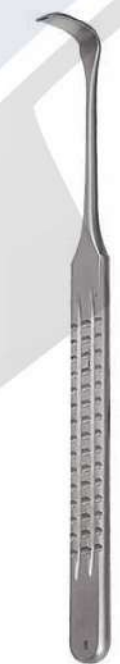

LANGENBECK-GREEN
16,0 cm, 6 1/4"



16 x 6 mm
HS-1919-01



24 x 6 mm
HS-1919-02



MEYERDING
18,0 cm, 7"



18 x 7 mm
HS-1920-01



16 x 5 mm
HS-1920-02



7 x 4 mm
HS-1920-03



14 x 8 mm
HS-1923-16



10 x 3 mm
HS-1921-04



7 x 4 mm
HS-1921-05



4 x 10 mm
HS-1921-06



16,0 cm, 6 1/4"



SENN-GREEN
15,0 cm, 6"



10 x 6 mm
HS-1924-10



20 x 6 mm
HS-1924-20



MINI-LANGENBECK
16,0 cm, 6 1/4"



10 x 6 mm
HS-1925-01

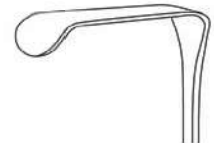

17 x 5 mm
HS-1925-02



20 x 6 mm
HS-1926-03



22 x 8 mm
HS-1926-04



RAGNELL-DAVIS
14,0 cm, 5 1/2"
HS-1927-14



RAGNELL
15,0 cm, 6"
HS-1928-15



BABY SENN-MILLER
15,0 cm, 6"

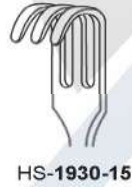

HS-1929-15

scharf
sharp
agudos
acuti

HS-1930-15

stumpf
blunt
romo
smusso

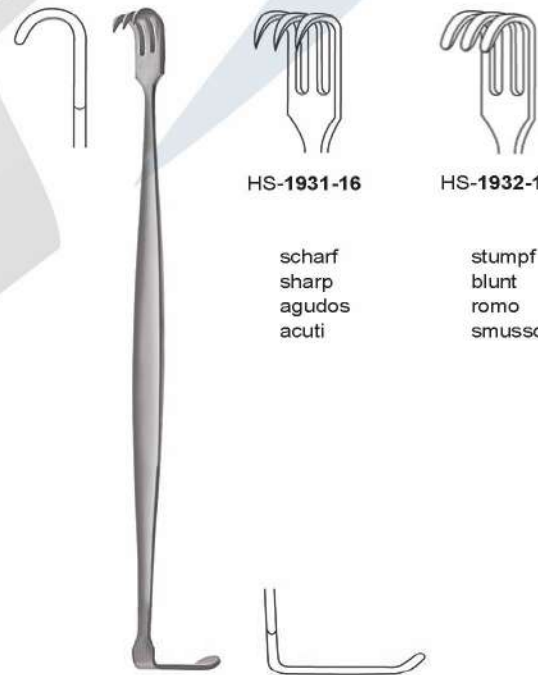

SENN-MILLER
16,0 cm, 6 1/4"



HS-1931-16

scharf
sharp
agudos
acuti



HS-1932-16

stumpf
blunt
romo
smusso



DESMARRES
13,0 cm, 5"



8 mm
HS-1933-08



10 mm
HS-1933-10

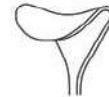

12 mm
HS-1933-12



14 mm
HS-1933-14



16 mm
HS-1933-16

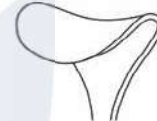

18 mm
HS-1933-18



DESMARRES
16,0 cm, 6 1/4"



8 mm
HS-1934-08



10 mm
HS-1934-10



12 mm
HS-1934-12



14 mm
HS-1934-14



16 mm
HS-1934-16

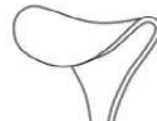

18 mm
HS-1934-18

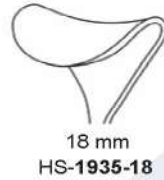
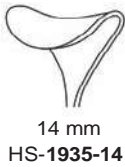

CUSHING
20,0 cm, 8"

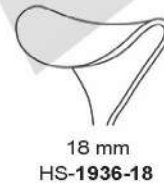

CUSHING
24,0 cm, 9 1/2"



GIL-VERNET
24,0 cm, 9 1/2"



8 mm
HS-1937-08



11 mm
HS-1937-11



13 mm
HS-1937-13



17 mm
HS-1937-17



20 mm
HS-1937-20



23 mm
HS-1937-23



GIL-VERNET
24,0 cm, 9 1/2"



8 mm
HS-1938-08



11 mm
HS-1938-11



13 mm
HS-1938-13



17 mm
HS-1938-17



20 mm
HS-1938-20



23 mm
HS-1938-23



Fig. 1 24 x 20 mm
Fig. 2 29 x 26 mm
Fig. 3 33 x 29 mm
Fig. 4 29 x 24 mm

Satz, Fig. 1-3
Set, fig. 1-3
Juego, fig. 1-3
Serie, fig. 1-3

Fig. 1 30 x 28 mm
Fig. 2 36 x 36 mm
Fig. 3 38 x 43 mm
Fig. 4 45 x 28 mm

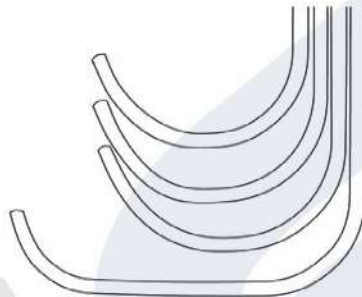
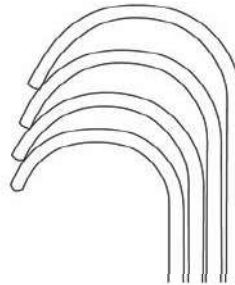

Fig. 1-3	17,0 cm, 6 ³ / ₄ "	HS-1940-00
Fig. 1	14,0 cm, 5 ¹ / ₂ "	HS-1940-01
Fig. 2	15,0 cm, 6"	HS-1940-02
Fig. 3	17,0 cm, 6 ³ / ₄ "	HS-1940-03
Fig. 4	18,0 cm, 7"	HS-1940-04

ROUX
HS-1939-12



Fig. 2 30 x 10 mm
Fig. 1 26 x 10 mm



Fig. 1 30 x 13 mm
Fig. 2 34 x 13 mm

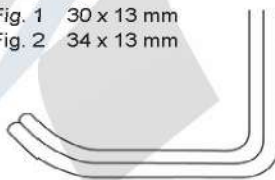

FARABEUF
12,0 cm, 4³/₄"
HS-1941-12



Fig. 2 23 x 16 mm
Fig. 1 27 x 16 mm

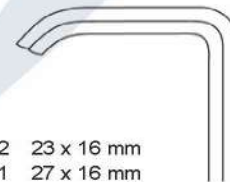
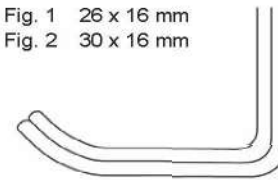

Fig. 1 26 x 16 mm
Fig. 2 30 x 16 mm



FARABEUF
15,0 cm, 5³/₄"
HS-1941-15



MINI-ROUX
14,0 cm, 5 1/2"
HS-1942-06



BABY-ROUX
13,0 cm, 5"
HS-1943-13



18 x 17 mm



24 x 21 mm



PARKER
13,5 cm, 5 3/8"
HS-1944-00

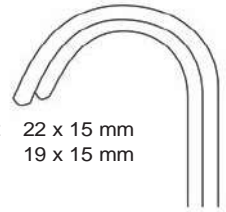

Fig. 2 22 x 15 mm
Fig. 1 19 x 15 mm

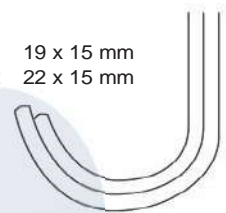

Fig. 1 19 x 15 mm
Fig. 2 22 x 15 mm



CZERNY
17,5 cm, 7"
HS-1945-00



36 mm

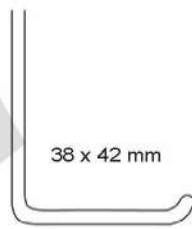

38 x 42 mm



MATHIEU
20,0 cm, 8"
HS-1946-00

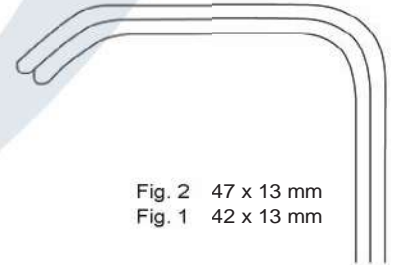

Fig. 2 47 x 13 mm
Fig. 1 42 x 13 mm

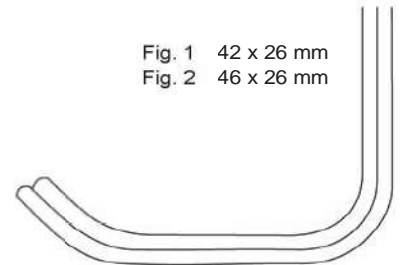
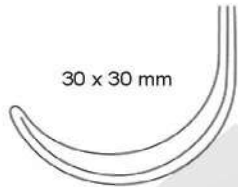
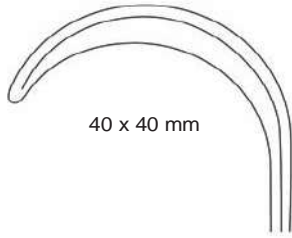

Fig. 1 42 x 26 mm
Fig. 2 46 x 26 mm



GOELET
19,0 cm, 7 1/2"
HS-1947-19



PARKER-LANGENBECK
21,0 cm, 8 1/4"
HS-1948-00

Fig. 2 25 x 24 mm
Fig. 1 21 x 24 mm

Fig. 1 40 x 15 mm
Fig. 2 45 x 15 mm



CANNY RYAL

16 mm	19,0 cm, 7 1/2"	HS-1949-16
20 mm	19,0 cm, 7 1/2"	HS-1949-20
25 mm	20,0 cm, 8"	HS-1949-25



VOLKMANN
21,5 cm, 8 1/2"



HS-1950-01



9 x 8 mm
HS-1950-02



9 x 13 mm
HS-1950-03



9 x 19 mm
HS-1950-04



9 x 29 mm
HS-1950-06



9 x 40 mm
HS-1950-08

scharf
sharp
agudos
acuti



VOLKMANN
21,5 cm, 8 1/2"



HS-1951-01



9 x 8 mm
HS-1951-02



9 x 13 mm
HS-1951-03



9 x 19 mm
HS-1951-04



9 x 29 mm
HS-1951-06



9 x 40 mm
HS-1951-08

halbscharf
semi-sharp
semi-agudos
semi-acuti



VOLKMANN
21,5 cm, 8 1/2"



HS-1952-01



9 x 8 mm
HS-1952-02



9 x 13 mm
HS-1952-03



stumpf
blunt
romo
smusso



9 x 19 mm
HS-1952-04

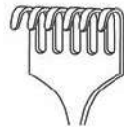

9 x 29 mm
HS-1952-06



9 x 40 mm
HS-1952-08



KOCHER
22,0 cm, 8 5/8"



HS-1953-01



9 x 8 mm
HS-1953-02



15 x 15 mm
HS-1953-03



scharf
sharp
agudos
acuti



15 x 20 mm
HS-1953-04

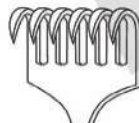

15 x 30 mm
HS-1953-06

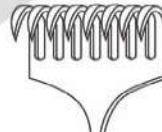

15 x 40 mm
HS-1953-08

S U R G I C A L



KOCHER
22,0 cm, 8⁵/₈"



HS-1954-01



9 x 8 mm
HS-1954-02



15 x 15 mm
HS-1954-03



15 x 20 mm
HS-1954-04



15 x 30 mm
HS-1954-06



15 x 40 mm
HS-1954-08

halbscharf
semi-sharp
semi-agudos
semi-acuti



KOCHER
22,0 cm, 8⁵/₈"



HS-1955-01



9 x 8 mm
HS-1955-02



15 x 15 mm
HS-1955-03



15 x 20 mm
HS-1955-04



15 x 30 mm
HS-1955-06

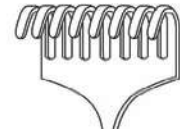

15 x 40 mm
HS-1955-08

stumpf
blunt
romo
smusso



26 x 40 mm
HS-1956-24

stumpf
blunt
romo
smusso



26 x 40 mm
HS-1957-24

scharf
sharp
agudos
acuti

KOERTE
24,0 cm, 9 1/2"



55 x 20 mm
HS-1956-55

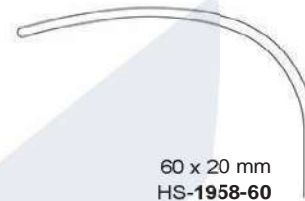

60 x 20 mm
HS-1958-60

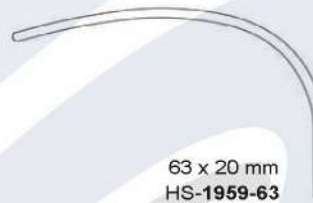

63 x 20 mm
HS-1959-63

LANGENBECK
21,0 cm, 8 1/4"



40 x 40 mm
HS-1960-04

4 Tähne
4 teeth
4 dientes
4 denti

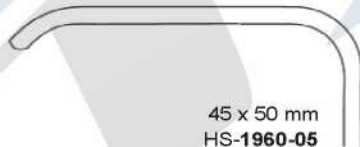

45 x 50 mm
HS-1960-05

5 Tähne
5 teeth
5 dientes
5 denti

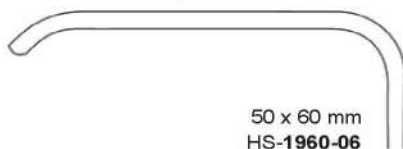

50 x 60 mm
HS-1960-06

6 Tähne
6 teeth
6 dientes
6 denti



70 x 70 mm
HS-1960-07

6 Tähne
6 teeth
6 dientes
6 denti

ISRAEL
25,0 cm, 9 3/4"



LANGENBECK
22,0 cm, 8⁵/₈"

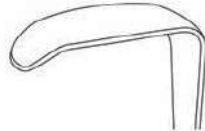

30 x 11 mm
HS-1961-30

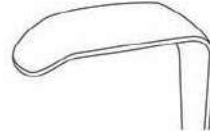

30 x 14 mm
HS-1961-31



30 x 16 mm
HS-1961-32

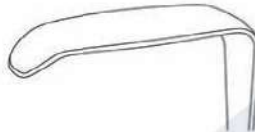

40 x 11 mm
HS-1961-40

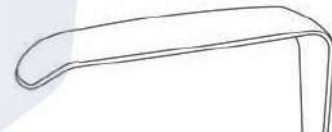

50 x 11 mm
HS-1961-50



LANGENBECK
22,0 cm, 8⁵/₈"



30 x 11 mm
HS-1962-30

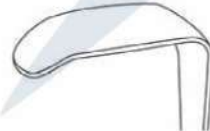

30 x 14 mm
HS-1962-31

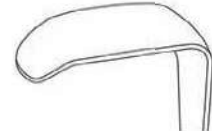

30 x 16 mm
HS-1962-32



40 x 11 mm
HS-1962-40

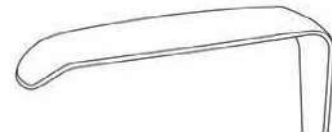

50 x 11 mm
HS-1962-50



KOCHER-LANGENBECK
21,5 cm, 8½"



22 x 6 mm
HS-1963-22



25 x 6 mm
HS-1963-25



25 x 8 mm
HS-1963-26



35 x 8 mm
HS-1963-35



35 x 11 mm
HS-1963-36



35 x 15 mm
HS-1963-37



40 x 11 mm
HS-1963-40



70 x 15 mm
HS-1963-70



80 x 12 mm
HS-1963-80



80 x 15 mm
HS-1963-85



22 x 6 mm
HS-1963-22



KOCHER
23,0 cm, 9"



40 x 18 mm
HS-1964-18



60 x 20 mm
HS-1964-20



60 x 25 mm
HS-1964-25



75 x 30 mm
HS-1964-30

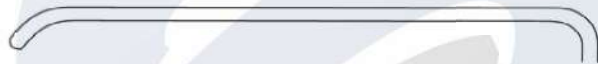

75 x 40 mm
HS-1964-40



SAUERBRUCH
22,5 cm, 8¾"



44 x 16 mm
HS-1965-44



55 x 22 mm
HS-1965-55



72 x 19 mm
HS-1965-72



MIDDELDORPF



MIDDELDORPF

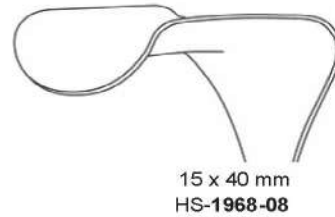
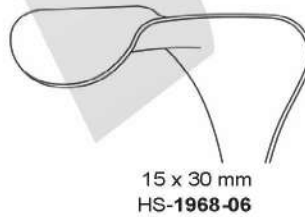
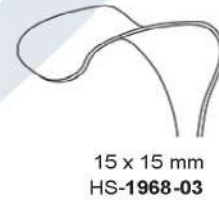

RICHARDSON (KELLY)
24,0 cm, 9¹/₂"

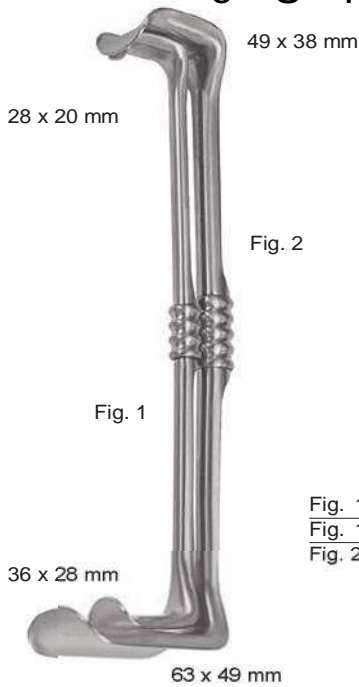
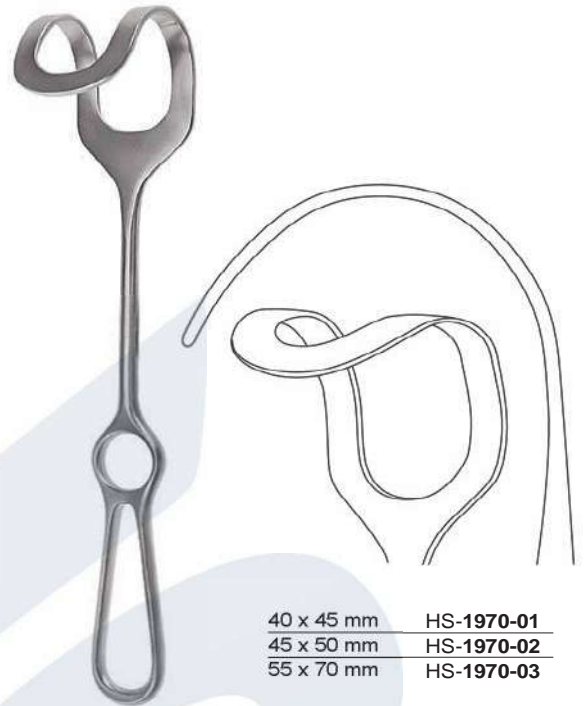

Fig. 1+2 28,0 cm, 11" HS-1969-00
 Fig. 1 26,0 cm, 10¹/₄" HS-1969-01
 Fig. 2 28,0 cm, 11" HS-1969-02

RICHARDSON-EASTMAN



MIDDELDORPF
 25,5 cm, 10"



FRITSCH
 24,0 cm, 9¹/₂"



DOYEN
 25,0 cm, 10"
 HS-1972-86



DOYEN-STILLE
22,0 cm, 8⁵/₈"

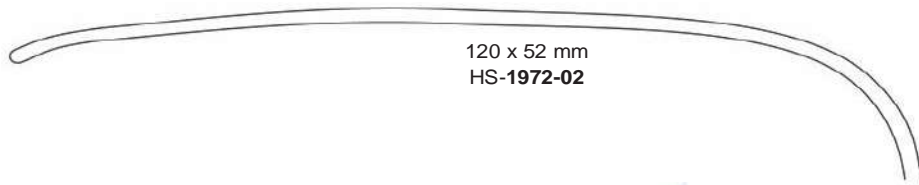

120 x 52 mm
HS-1972-02



105 x 30 mm
HS-1972-02

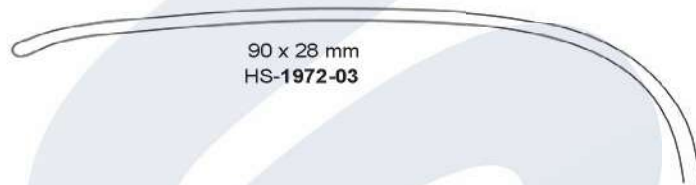

90 x 28 mm
HS-1972-03



ROCHER
25,0 cm, 10"

70 x 25 mm	HS-1973-70
80 x 42 mm	HS-1973-81
80 x 50 mm	HS-1973-82
80 x 60 mm	HS-1973-83



LAHEY
19,0 cm, 7¹/₂"
HS-1974-19

28 x 6 mm



12 x 14 mm

LITTLE
20,0 cm, 8"
HS-1976-20



115 x 22 mm HS-1975-01
115 x 27 mm HS-1975-02

SIMON
28,0 cm, 11"



160 x 38 mm HS-1977-61
160 x 57 mm HS-1977-62
190 x 38 mm HS-1977-91
190 x 57 mm HS-1977-92

KELLY
27,0 cm, 10½"



85 x 35 mm HS-1978-01
120 x 50 mm HS-1978-02
155 x 50 mm HS-1978-03

MIKULICZ
26,0 cm, 10¹/₄"



90 x 50 mm

MIKULICZ
26,0 cm, 10¹/₄"
HS-1980-90



70 x 38 mm HS-1979-38
70 x 50 mm HS-1979-51

MORRIS
24,5 cm, 9⁵/₈"



127 x 40 mm HS-1982-40
127 x 62 mm HS-1982-62

HARRINGTON
32,0 cm, 12 1/2"



82 x 22 mm HS-1981-01
108 x 43 mm HS-1981-02
115 x 65 mm HS-1981-03

CORYKKOS
24,0 cm, 9 1/2"

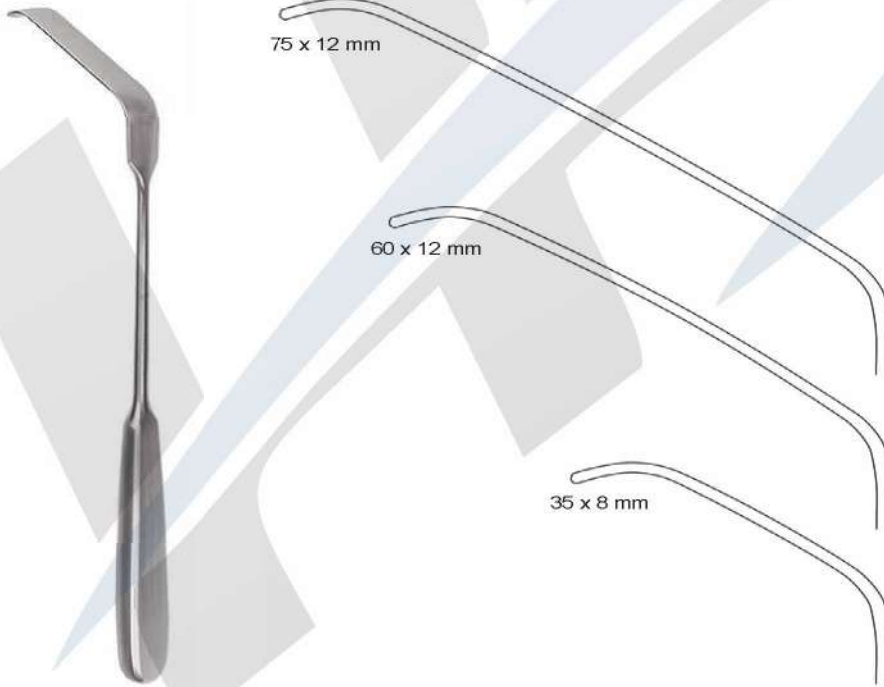

ZENKER

25,0 cm, 9 3/4"
HS-1983-25

35 x 8 mm

26,0 cm, 10 1/4"
HS-1983-26

27,5 cm, 10 3/4"
HS-1983-27



MEYERDING
22,5 cm, 8³/₄"

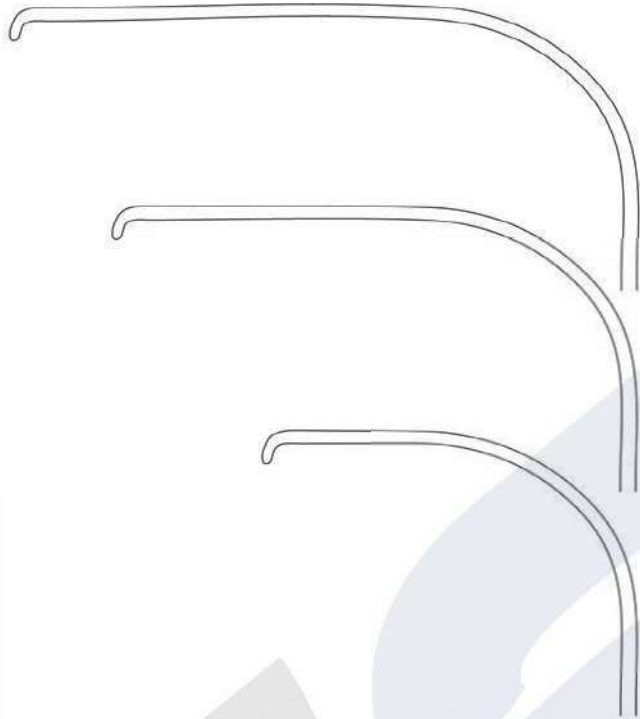

90 x 50 mm
HS-1984-50

75 x 25 mm
HS-1984-25

50 x 16 mm
HS-1984-16



BRUNNER
25,0 cm, 10"

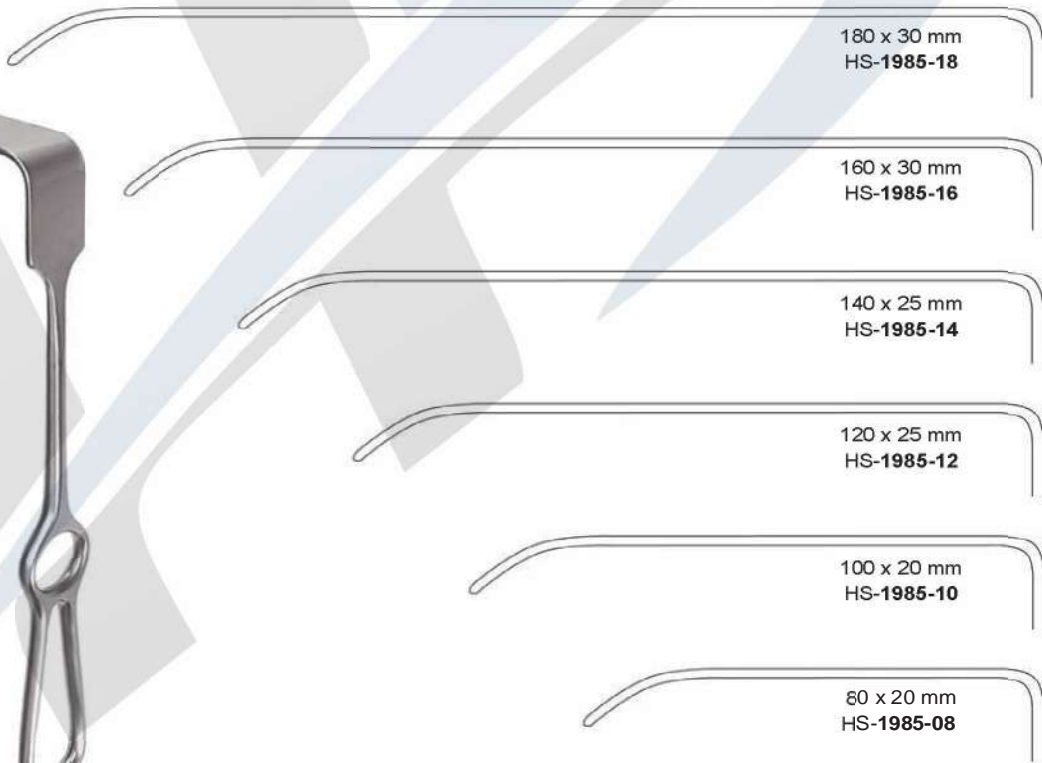

180 x 30 mm
HS-1985-18

160 x 30 mm
HS-1985-16

140 x 25 mm
HS-1985-14

120 x 25 mm
HS-1985-12

100 x 20 mm
HS-1985-10

60 x 20 mm
HS-1985-08



BRUNNER
25,0 cm, 10"

180 x 30 mm
HS-1986-18

160 x 30 mm
HS-1986-16

140 x 25 mm
HS-1986-14

120 x 25 mm
HS-1986-12

100 x 20 mm
HS-1986-10

80 x 20 mm
HS-1986-08

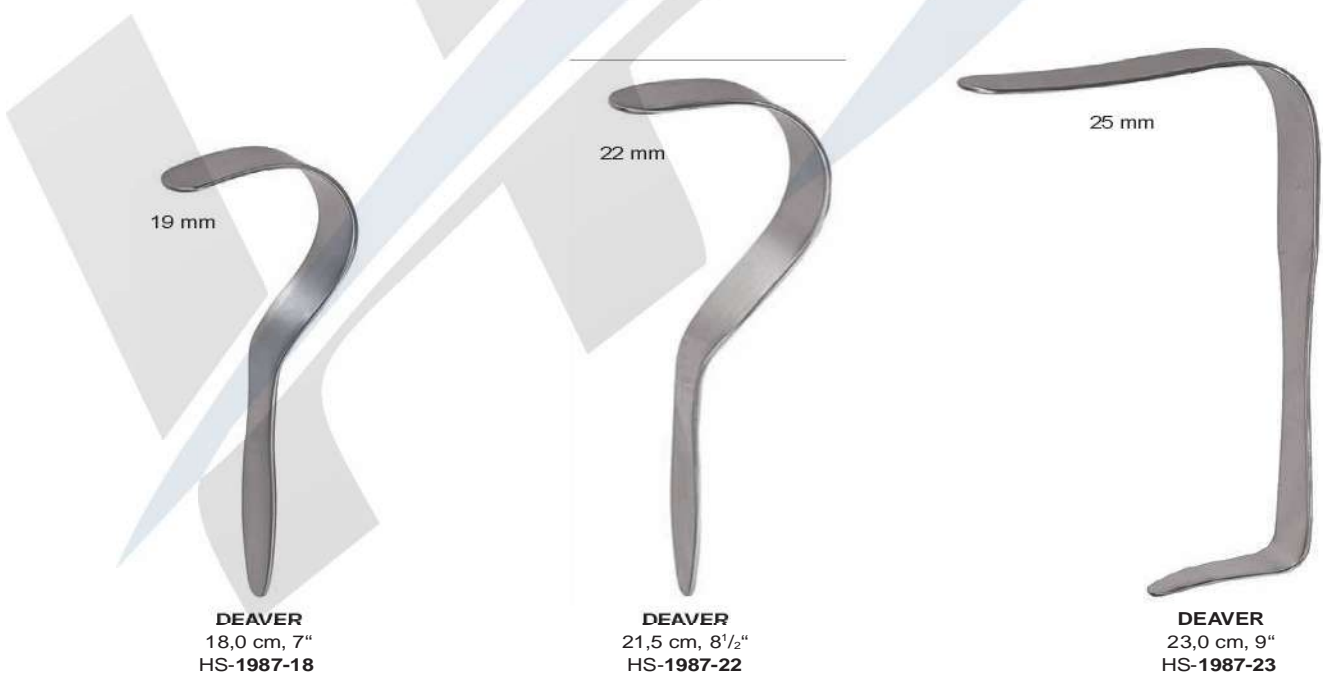

19 mm

22 mm

25 mm

DEAVER
18,0 cm, 7"
HS-1987-18

DEAVER
21,5 cm, 8½"
HS-1987-22

DEAVER
23,0 cm, 9"
HS-1987-23



25 mm

DEAVER
30,0 cm, 11³/₄"
HS-1987-30



25 mm

DEAVER
33,0 cm, 13"
HS-1987-33



25 mm

DEAVER
36,0 cm, 14¹/₈"
HS-1987-36



38 mm

DEAVER
30,0 cm, 11³/₄"
HS-1987-38



50 mm

DEAVER
30,0 cm, 11³/₄"
HS-1987-50



75 mm

DEAVER
30,0 cm, 11³/₄"
HS-1987-75

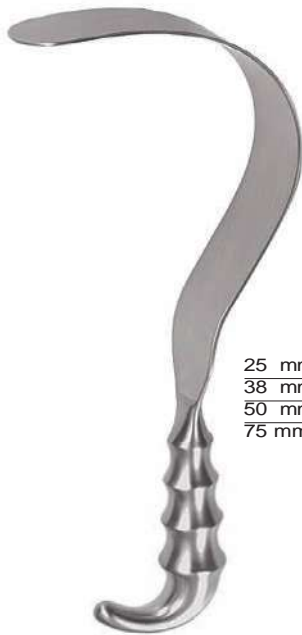

25 mm	HS-1988-25
38 mm	HS-1988-38
50 mm	HS-1988-50
75 mm	HS-1988-75

DEAVER GRIP
30,0 cm, 11³/₄"



40 mm	30,0 cm, 11 ³ / ₄ "	HS-1989-30
54 mm	32,0 cm, 12 ¹ / ₂ "	HS-1989-32

ALLISON



75 x 50 mm	16,0 cm, 6 ¹ / ₄ "	HS-1990-50
75 x 90 mm	16,0 cm, 6 ¹ / ₄ "	HS-1990-90

DAVIDSON



ST MARKS

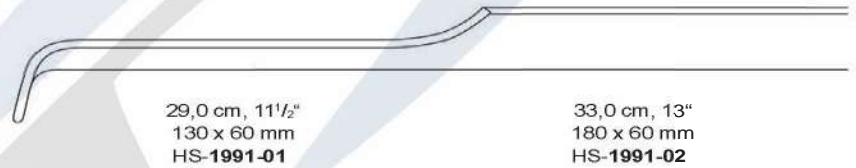

29,0 cm, 11¹/₂"
130 x 60 mm
HS-1991-01

33,0 cm, 13"
180 x 60 mm
HS-1991-02



29,0 cm, 11¹/₂"
130 x 60 mm
HS-1992-01

33,0 cm, 13"
180 x 60 mm
HS-1992-02

Wundspreizer
Self-Retaining Retractors
Separadores con retenida automática
Divaricatori autostatici





5,0 cm, 2"
HS-1993-05



5,0 cm, 2"
HS-1994-05



7,0 cm, 2 3/4"
HS-1993-07

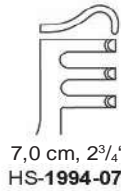

7,0 cm, 2 3/4"
HS-1994-07

scharf
sharp
agudos
acuti

stumpf
blunt
romo
smusso



JANSEN
10,0 cm, 4"

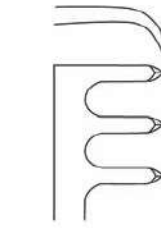

HS-1995-10

scharf
sharp
agudos
acuti

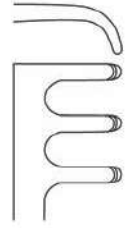

HS-1996-10

stumpf
blunt
romo
smusso



FINZEN



ALM

scharf
sharp
agudos
acuti

halbscharf
semi-sharp
semi-agudos
semi-acuti

stumpf
blunt
romo
smusso



7,0 cm, 2 3/4" HS-1997-07 HS-1998-07 HS-1999-07
10,0 cm, 4" HS-2000-10 HS-2001-10 HS-2002-10



ALLPORT
9,5 cm, 3 3/4"
HS-2003-09





SALP-CONTOUR
14,0 cm, 5 1/2"



HS-2004-14
scharf
sharp
agudos
acuti



HS-2005-14
stumpf
blunt
romo
smusso



ADSON-BABY
16,0 cm, 6 1/4"



HS-2006-16
scharf
sharp
agudos
acuti



HS-2007-16
stumpf
blunt
romo
smusso



ANDERSON-ADSON
20,0 cm, 8"



HS-2008-14
scharf
sharp
agudos
acuti



HS-2009-14
stumpf
blunt
romo
smusso



ADSON
26,5 cm, 10 1/2"



HS-2010-16
scharf
sharp
agudos
acuti



HS-2011-16
stumpf
blunt
romo
smusso



MOLLISON
15,5 cm, 6"
HS-2012-15



scharf
sharp
agudos
acuti



SCHUHKNECHT
12,5 cm, 5"



HS-2013-14
scharf
sharp
agudos
acuti



HS-2014-14
stumpf
blunt
romo
smusso



WULLSTEIN



scharf
sharp
agudos
acuti

stumpf
blunt
romo
smusso

10,5 cm, 4 1/8"	HS-2015-10	HS-2016-10
13,0 cm, 5"	HS-2015-13	HS-2016-13
15,0 cm, 6"	HS-2015-15	HS-2016-15
18,0 cm, 7"	HS-2015-18	HS-2016-18



MAYO-ADAMS
16,5 cm, 6 1/2"
HS-2017-17

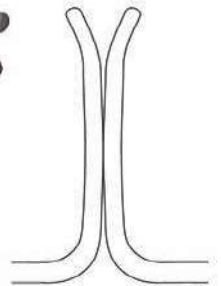



WEITLANER-LOKTITE
10,5 cm, 4¹/₈"



HS-2018-10
scharf
sharp
agudos
acuti



HS-2019-10
stumpf
blunt
romo
smusso



WEITLANER
13,0 cm, 5"



HS-2020-13
scharf
sharp
agudos
acuti



HS-2021-13
stumpf
blunt
romo
smusso



WEITLANER
16,5 cm, 6¹/₂"



HS-2022-16
scharf
sharp
agudos
acuti



HS-2023-16
stumpf
blunt
romo
smusso



WEITLANER
20,0 cm, 8"



HS-2024-20
scharf
sharp
agudos
acuti



HS-2025-20
stumpf
blunt
romo
smusso



WEITLANER
24,0 cm, 9 1/2"



HS-2026-20

scharf
sharp
agudos
acuti



HS-2027-20

stumpf
blunt
romo
smusso



PLESTER
13,0 cm, 5"



HS-2028-13

scharf
sharp
agudos
acuti



HS-2029-13

stumpf
blunt
romo
smusso



MILLIGAN
13,0 cm, 5"
HS-2030-13



PLESTER
11,0 cm, 4 3/8"
HS-2031-11

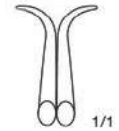

PLESTER
11,0 cm, 4 3/8"
HS-2032-11

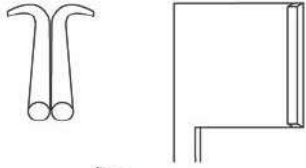

WEITLANER-BABY
13,0 cm, 5"
HS-2035-13



**ADSON
(CONE)**

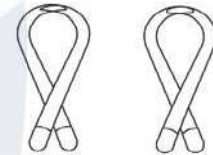

20,0 cm, 8" HS-2033-20 HS-2034-20
26,0 cm, 10 1/4" HS-2033-26 HS-2034-26

scharf	stumpf
sharp	blunt
agudos	romo
acuti	smusso



GELPI
13,5 cm, 5 3/8"
HS-2036-14



GELPI
19,0 cm, 7 1/2"
HS-2037-19



GELPI-LOKTITE
19,0 cm, 7 1/2"
HS-2038-19

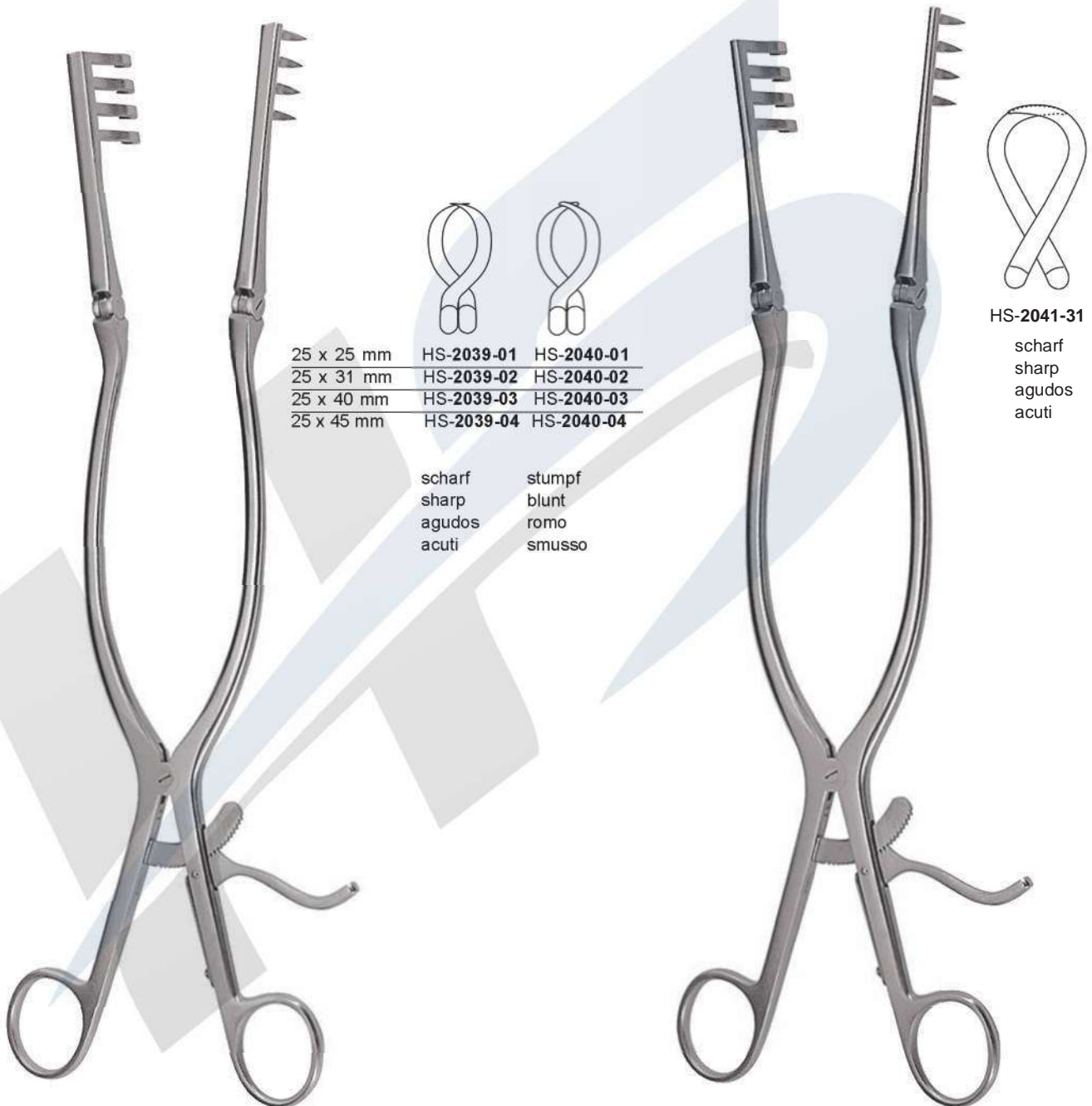

BECKMANN-ADSON
 31,0 cm, 12¹/₄"

BECKMANN
 31,0 cm, 12¹/₄"

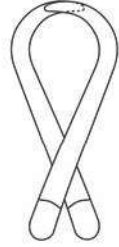

HS-2042-32

stumpf
blunt
romo
smusso



ADSON
32,0 cm, 12 1/2"



DE BAKEY

10,0 cm, 4" HS-2043-10
14,0 cm, 5 1/2" HS-2043-14



NORFOLK AND NORWICH
22,0 cm, 8⁵/₈"
HS-2044-22



stumpf
blunt
romo
smusso



JACKSON BURROWS
17,5 cm, 7"
HS-2045-17



stumpf
blunt
romo
smusso



RICHTER
17,0 cm, 6³/₄"
HS-2046-17



JOLL (FRIEDMAN)
15,5 cm, 6"
HS-2047-15



HENLEY
16,0 cm, 6 1/4"
HS-2048-16

scharf
sharp
agudos
acuti

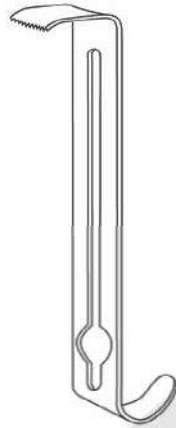

19 x 16 mm
HS-2048-19

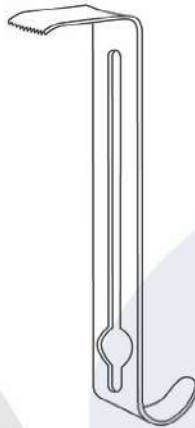

25 x 16 mm
HS-2048-25

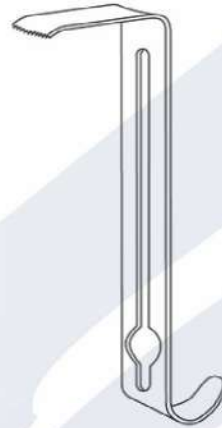

32 x 16 mm
HS-2048-32

stumpf
blunt
romo
smusso



HENLEY
16,0 cm, 6 1/4"
HS-2049-16

HENLEY
HS-2050-00

komplett, bestehend aus:

- 1 Sperrer mit Seitenventilen, scharf (HS-300-16)
- 1 Mittelvalve 19 x 16 mm (HS-300-19)
- 1 Mittelvalve 25 x 16 mm (HS-300-25)
- 1 Mittelvalve 32 x 16 mm (HS-300-32)

complete, consisting of:

- 1 Spreader with lateral valves, sharp (HS-300-16)
- 1 Central valve 19 x 16 mm (HS-300-19)
- 1 Central valve 25 x 16 mm (HS-300-25)
- 1 Central valve 32 x 16 mm (HS-300-32)

completo, compuesto of:

- 1 Separador con valvas laterales, agudas (HS-300-16)
- 1 Valva central 19 x 16 mm (HS-300-19)
- 1 Valva central 25 x 16 mm (HS-300-25)
- 1 Valva central 32 x 16 mm (HS-300-32)

completo, composto da:

- 1 Divaricatore con valve laterali, acuto (HS-300-16)
- 1 Valva centrale 19 x 16 mm (HS-300-19)
- 1 Valva centrale 25 x 16 mm (HS-300-25)
- 1 Valva centrale 32 x 16 mm (HS-300-32)

HENLEY
HS-2051-00

komplett, bestehend aus:

- 1 Sperrer mit Seitenventilen, stumpf (HS-301-16)
- 1 Mittelvalve 19 x 16 mm (HS-300-19)
- 1 Mittelvalve 25 x 16 mm (HS-300-25)
- 1 Mittelvalve 32 x 16 mm (HS-300-32)

complete, consisting of:

- 1 Spreader with lateral valves, blunt (HS-301-16)
- 1 Central valve 19 x 16 mm (HS-300-19)
- 1 Central valve 25 x 16 mm (HS-300-25)
- 1 Central valve 32 x 16 mm (HS-300-32)

completo, compuesto of:

- 1 Separador con valvas laterales, romas (HS-301-16)
- 1 Valva central 19 x 16 mm (HS-300-19)
- 1 Valva central 25 x 16 mm (HS-300-25)
- 1 Valva central 32 x 16 mm (HS-300-32)

completo, composto da:

- 1 Divaricatore con valve laterali, smusso (HS-301-16)
- 1 Valva centrale 19 x 16 mm (HS-300-19)
- 1 Valva centrale 25 x 16 mm (HS-300-25)
- 1 Valva centrale 32 x 16 mm (HS-300-32)

Wundspreizer, Bauchdeckenhalter
 Self-Retaining Retractors, Abdominal Retractors
 Separadores con retenida automática, Separadores abdominales
 Divaricatori autostatici, Divaricatori addominali



MAYO-ADAMS
 17,0 cm, 6³/₄"
 HS-2054-17



COLLIN-BABY
 18,0 cm, 7"
 HS-2055-18

30 x 44 mm
 HS-2052-30



23 x 44 mm
 HS-2053-23

Wechselvalven
 Exchangeable blades
 Valvas intergambiabiles
 Valve intercambiabili

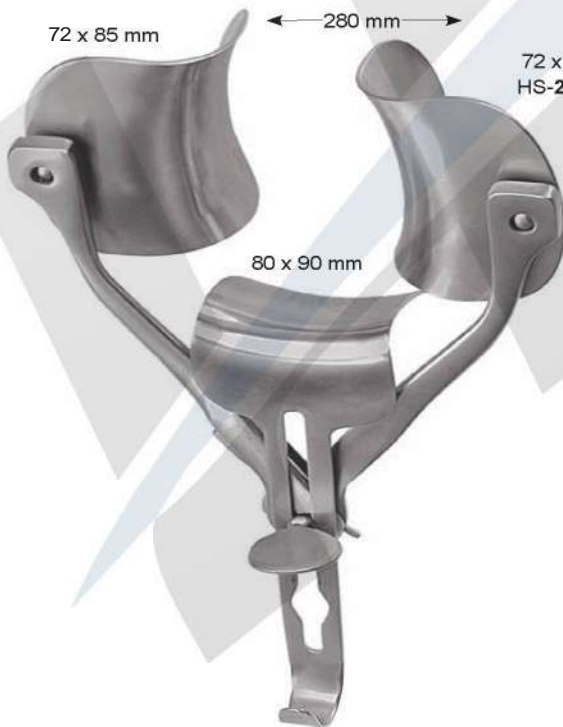

RICARD
 28,0 cm, 11"
 HS-2056-28



RICARD
 30,0 cm, 12"
 HS-2057-30



HAGGAI

S U R G I C A L

Wundspreizer, Bauchdeckenhalter
Self-Retaining Retractors, Abdominal Retractors
Separadores con retenida automática, Separadores abdominales
Divaricatori autostatici, Divaricatori addominali

38 x 62 mm
HS-2058-10

135-160 mm



38 x 62 mm

55 x 55 mm

COLLIN
23,5 cm, 9 1/4"
HS-2058-24

40 x 80 mm

135-160 mm



40 x 80 mm
HS-2059-11

55 x 65 mm

COLLIN
23,5 cm, 9 1/4"
HS-2059-24

60 x 80 mm
HS-2060-13

135-160 mm



60 x 80 mm

60 x 75 mm

COLLIN
23,5 cm, 9 1/4"
HS-2060-24

38 x 64 mm
HS-2061-01

38 x 64 mm

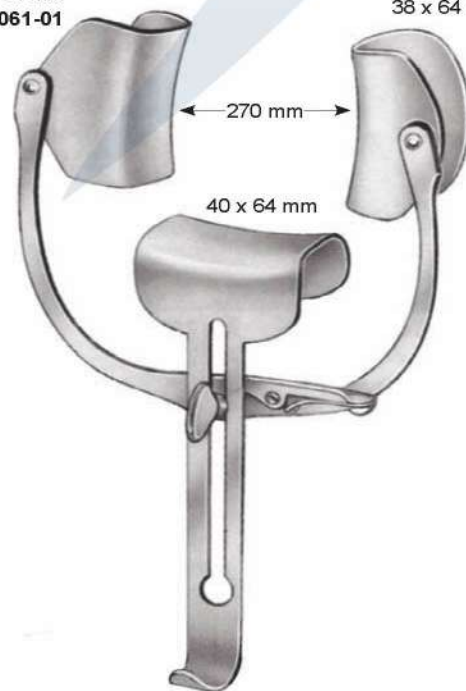

270 mm

40 x 64 mm

ROBIN-MASSE
HS-2061-27



HAGGAI

Wundspreizer, Bauchdeckenhalter
Self-Retaining Retractors, Abdominal Retractors
Separadores con retenida automática, Separadores abdominales
Divaricatori autostatici, Divaricatori addominali

S U R G I C A L



38 x 62 mm HS-2062-01
40 x 80 mm HS-2062-02
60 x 80 mm HS-2062-03

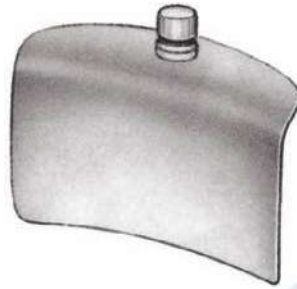

50 x 58 mm HS-2063-10
60 x 80 mm HS-2063-13
72 x 85 mm HS-2063-14



HS-2064-23
60 x 80 mm



HS-2067-33
60 x 80 mm



58 x 50 mm HS-2065-01
80 x 60 mm HS-2065-02
85 x 72 mm HS-2065-03



62 x 38 mm HS-2066-10
80 x 38 mm HS-2066-11
100 x 38 mm HS-2066-12
80 x 38 mm HS-2066-13



COLLIN
55 x 55 mm HS-2068-01
55 x 65 mm HS-2068-02
55 x 75 mm HS-2068-03



ROBIN-MASSE
40 x 64 mm HS-2069-01
55 x 65 mm HS-2069-02
55 x 75 mm HS-2069-03



RICARD
65 x 50 mm HS-2070-01
70 x 55 mm HS-2070-02
90 x 80 mm HS-2070-03



HAGGAI

S U R G I C A L

Bauchdeckenhalter
Abdominal Retractors
Separadores abdominales
Divaricatori addominali



GOSSET
HS-2071-10



GOSSET
HS-2072-14



GOSSET
HS-2073-16



ABADIE
HS-2074-12



BALFOUR
HS-2075-18



BALFOUR
HS-2076-20



BALFOUR
HS-2077-25

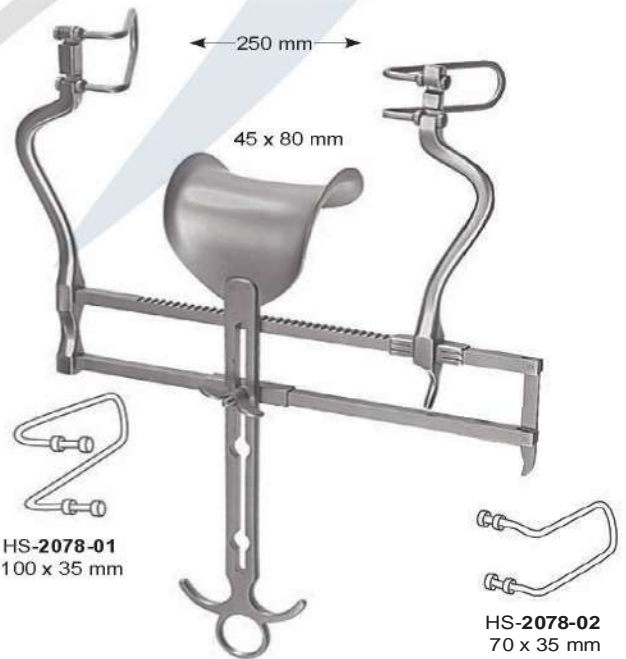

BALFOUR US-TYPE
HS-2078-25

HS-2078-01
100 x 35 mm

HS-2078-02
70 x 35 mm



BALFOUR
100 x 70 mm
HS-2079-70

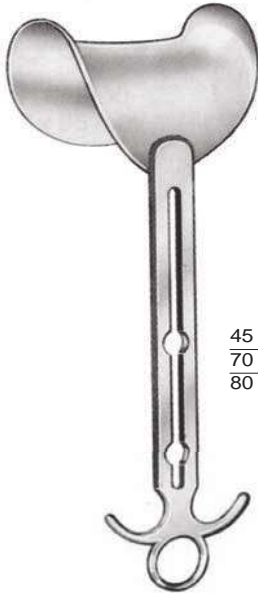

BALFOUR

45 x 80 mm	HS-2079-01
70 x 85 mm	HS-2079-02
80 x 90 mm	HS-2079-03

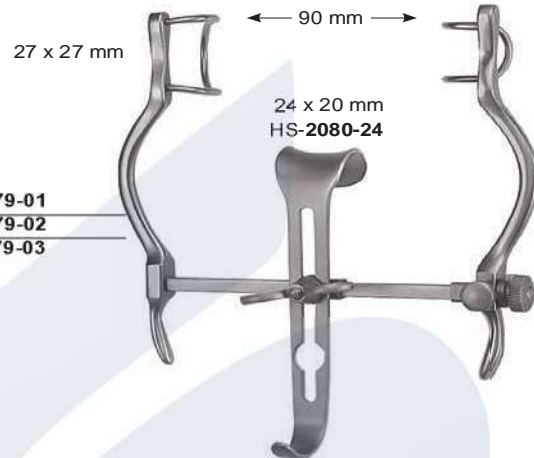

BALFOUR
HS-2080-09



BERKELEY
HS-2081-00

35 x 60 mm
HS-2081-01

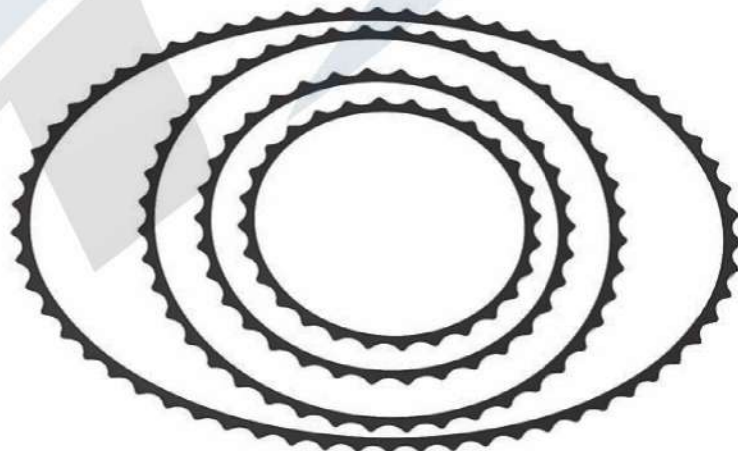

TURNER-WARNICK
modifiziert

Ø 180 mm, 7"	HS-2081-18
Ø 230 mm, 9"	HS-2081-23
Ø 305 mm, 12"	HS-2081-30
455 x 330 mm	HS-2081-45

geschwärzt, black finish, negra, nera



TURNER-WARNICK
modifiziert

geschwärzt, black finish, negra, nera



HS-2084-11
40 x 30 mm

HS-2084-22
40 x 40 mm



40 x 30 mm

40 x 40 mm

HS-2084-01
255 x 180 mm
Rahmen allein
frame only
cuadro suelto
solo telaio

DENNIS BROWN
255 x 180 mm
HS-2084-00
komplett complete
completo completo

HS-2085-11
80 x 45 mm

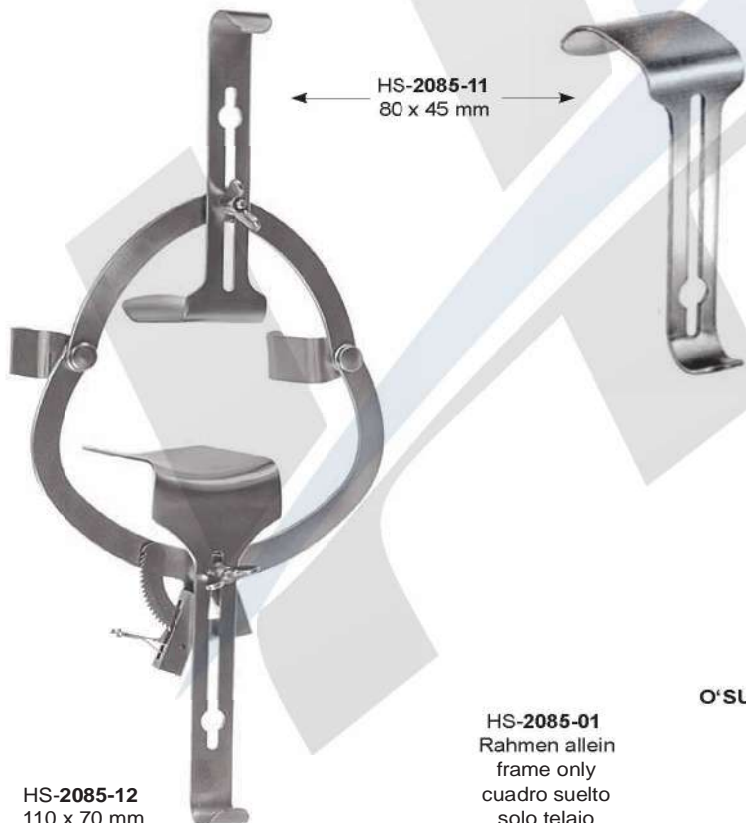

HS-2085-12
110 x 70 mm

HS-2085-01
Rahmen allein
frame only
cuadro suelto
solo telaio

O'SULLIVAN-O'CONNOR
HS-2085-00
komplett
complete
completo completo

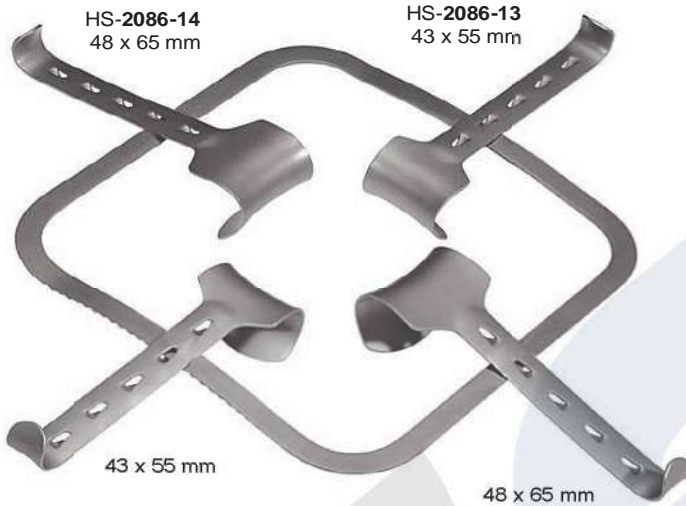

HS-2086-01 250 x 250 mm
HS-2087-01 300 x 320 mm
HS-2088-01 300 x 380 mm
Rahmen allein
frame only
cuadro suelto
solo telaio

KIRSCHNER
HS-2089-00
komplett
complete
completo
completo
1 x HS-880-01
2 x HS-880-13
2 x HS-880-14



HS-2090-01
255 x 255 mm
zusammenlegbarer Rahmen, allein
folding frame, only
cuadro plegable, suelto
telaio pieghevole, solo

KIRSCHNER
HS-2090-00
komplett
complete
completo
completo
1 x HS-882-01
2 x HS-880-13
2 x HS-880-14



43 x 55 mm	HS-2091-13
48 x 65 mm	HS-2091-14
80 x 90 mm	HS-2091-15
90 x 65 mm	HS-2091-16
98x95mm	HS-2091-17

KIRSCHNER



KIRSCHNER
60 x 82 mm
HS-2092-11



KIRSCHNER-BALFOUR
83 x 82 mm
HS-2092-12



KIRSCHNER
98 x 51 mm HS-2092-20
105 x 38 mm HS-2092-21

HS-2093-14
48 x 65 mm



HS-2094-01
300 x 240 mm
Rahmen allein
frame only
cuadro suelto
solo telaio

HS-2095-15
80 x 90 mm

- KIRSCHNER, oval**
HS-2096-00
komplett, complete, completo, completo
- 1 x HS-094-01
 - 3 x HS-093-14
 - 1 x HS-095-15
 - 1 x HS-097-20
 - 1 x HS-097-21



KIRSCHNER
98 x 51 mm HS-2097-20
105 x 38 mm HS-2097-21

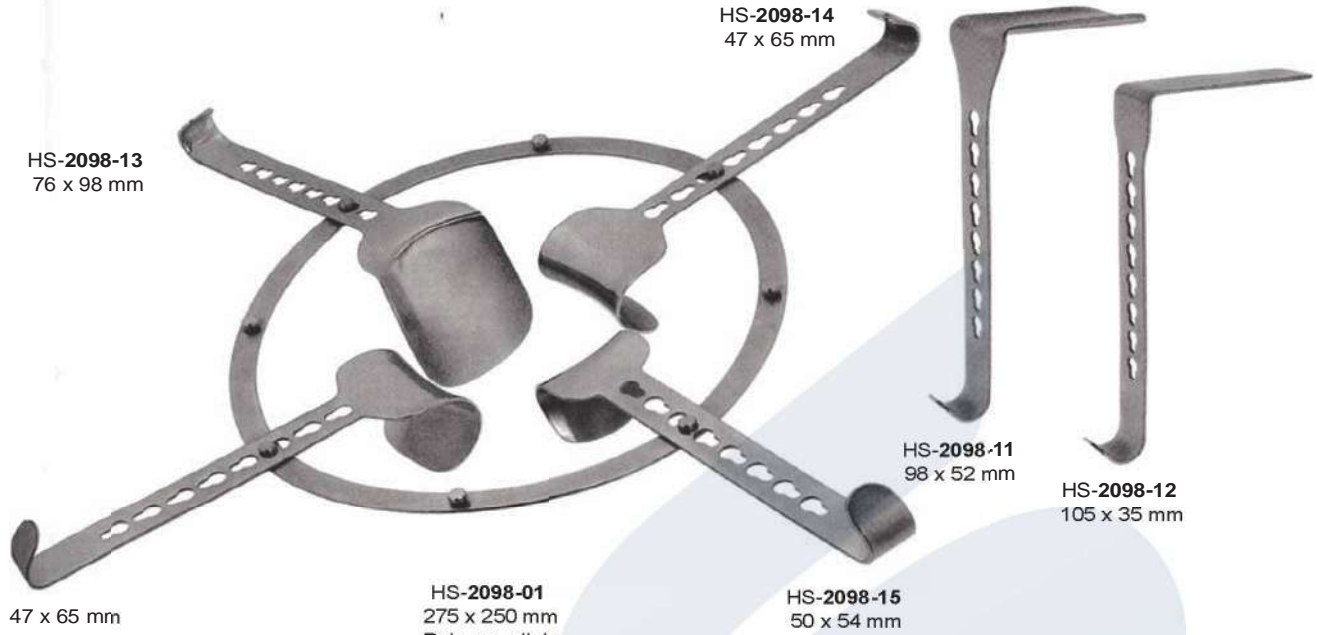

HS-2098-13
76 x 98 mm

HS-2098-14
47 x 65 mm

HS-2098-11
98 x 52 mm

HS-2098-12
105 x 35 mm

47 x 65 mm

HS-2098-01
275 x 250 mm
Rahmen allein
frame only
cuadro suelto
solo telaio

HS-2098-15
50 x 54 mm



HS-2099-13
38 x 60 mm

HS-2099-11
50 x 65 mm

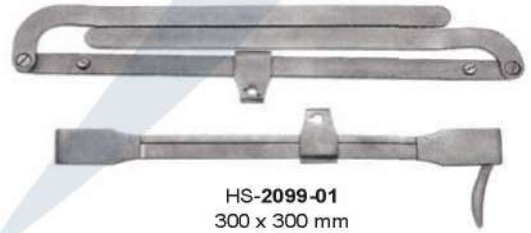

HS-2099-01
300 x 300 mm
zusammenlegbarer Rahmen, allein
folding frame, only
cuadro plegable, suelto
telaio pieghevole, solo

FRANZ
RT-2099-00
komplett
complete
completo
completo
1 x HS-2099-01
2 x HS-2099-11
2 x HS-2099-13



38 x 60 mm HS-2099-13
45 x 80 mm HS-2099-14

50 x 65 mm HS-2099-11
60 x 85 mm HS-2099-12



für / for / para / per
HS-2100-11
HS-2100-14



95 x 60 mm HS-2100-11
105 x 65 mm HS-2100-12
115 x 65 mm HS-2101-13
125 x 65 mm HS-2101-14

DOYEN
28,0 cm, 11"



Kette mit Gewicht
Chain with weight
Cadena con pesa
Catena con peso

HS-2102-30
78,5 cm, 31"



66,0 cm, 26"

Befestigungsgestell
Mounting frame
Bastidor para la fijación
Telaio di supporto per il fissaggio

ROCHARD
HS-2103-30



53,0 cm, 21"

66,0 cm, 26"

Befestigungsgestell
Mounting frame
Bastidor para la fijación
Telaio di supporto per il fissaggio

ROCHARD
HS-2104-02



ROCHARD
28,0 cm, 11"
HS-2104-20

95 x 48 mm HS-2104-10
105 x 48 mm HS-2104-12
115 x 48 mm HS-2104-12
125 x 48 mm HS-2104-13
155 x 48 mm HS-2104-16



ROCHARD
28,0 cm, 11"



biegsam
malleable
maleable
malleabile

- 200 x 6 mm HS-2105-06
- 200 x 12 mm HS-2105-12
- 200 x 17 mm HS-2105-17
- 200 x 20 mm HS-2105-20
- 200 x 25 mm HS-2105-25

RIBBON



biegsam
malleable
maleable
malleabile

- 330 x 13 mm HS-2106-13
- 330 x 25 mm HS-2106-25
- 330 x 32 mm HS-2106-32
- 330 x 40 mm HS-2106-40
- 330 x 50 mm HS-2106-50

RIBBON



biegsam
malleable
maleable
malleabile

- 280 x 25/30 mm HS-2107-01
- 300 x 37/45 mm HS-2107-02
- 300 x 40/50 mm HS-2107-03

RIBBON



biegsam
malleable
maleable
malleabile

TUFFIER
200 x 25/17 mm
HS-2108-20



REVERDIN
280 x 45/60 mm
HS-2109-28



rostfrei
stainless steel
inox
arrugginimento

a	b	c	
18 mm	20 mm	75 mm	HS-2110-01

FINOCCHIETTO-BABY

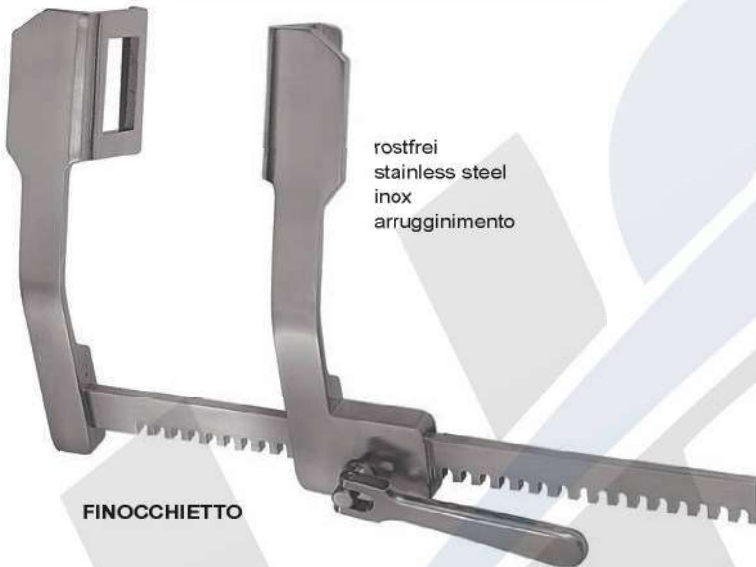

rostfrei
stainless steel
inox
arrugginimento

a	b	c	
40 mm	40 mm	165 mm	HS-2110-02
45 mm	65 mm	200 mm	HS-2110-03
70 mm	65 mm	250 mm	HS-2110-04

FINOCCHIETTO



rostfrei
stainless steel
inox
arrugginimento

a	b	c	
50 mm	45 mm	165 mm	HS-2111-01

TUFFIER

Sonden, Trokare
Probes, Trocars
Sondas, Trócares
Sonde, Trequarti



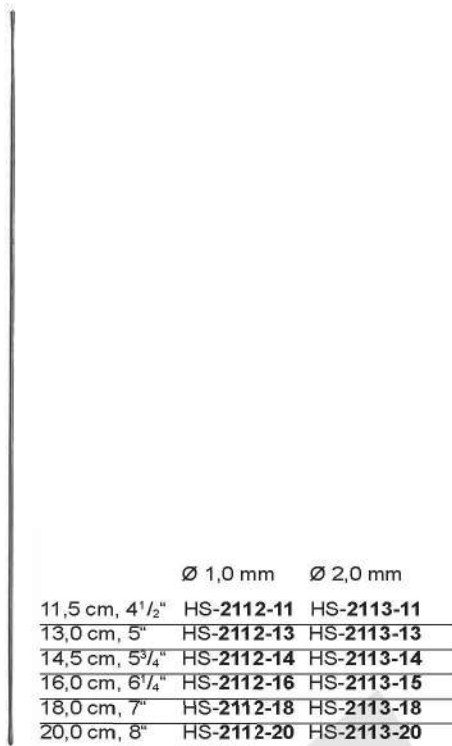

Ø 2,0 mm



11,5 cm, 4 1/2"	HS-2115-11
13,0 cm, 5"	HS-2115-13
14,5 cm, 5 3/4"	HS-2115-14
16,0 cm, 6 1/4"	HS-2115-16
18,0 cm, 7"	HS-2115-18
20,0 cm, 8"	HS-2115-20

Ø 1,0 mm



Silber
Silver
Plata
Argento

STACKE
10,5 cm, 4 1/8"
HS-2115-10

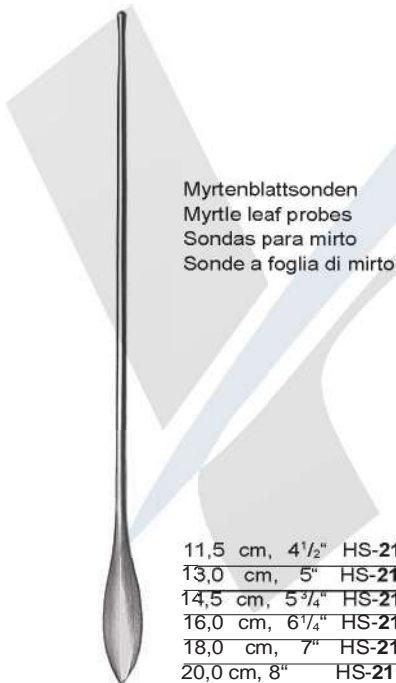

NÉLATON
16,0 cm, 6 1/4"
HS-2117-16



DOYEN
14,5 cm, 5 3/4"
HS-2118-14

Ø 3,5 mm



BRODIE
20,0 cm, 8"
HS-2119-20

Ø 3,5 mm



11,5 cm, 4 1/2"	HS-2120-11
13,0 cm, 5"	HS-2120-13
14,5 cm, 5 3/4"	HS-2120-14
16,0 cm, 6 1/4"	HS-2120-16
18,0 cm, 7"	HS-2120-18
20,0 cm, 8"	HS-2120-20

Ø 3,3 mm



13,0 cm, 5"	HS-2121-13
14,5 cm, 5 3/4"	HS-2121-14
16,0 cm, 6 1/4"	HS-2121-16
18,0 cm, 7"	HS-2121-18



LOCKHART-MUMMERY
16,5 cm, 6 1/2"
HS-2122-01



LOCKHART-MUMMERY
16,5 cm, 6 1/2"
HS-2122-02



LOCKHART-MUMMERY
16,5 cm, 6 1/2"
HS-2122-03



LOCKHART-MUMMERY
16,5 cm, 6 1/2"
HS-2122-04



FEIN
28,0 cm, 11"
HS-2123-28



UKERMANN
16,0 cm, 6 1/4"
HS-2124-16



JOBSON-HORNE
18,0 cm, 7"
HS-2125-18



**FARRELL
(LATHBURY)**

12,0 cm, 4 3/4"	HS-2126-12	Ø 0,9 mm
14,0 cm, 5 3/4"	HS-2126-14	Ø 0,9 mm
16,5 cm, 6 1/4"	HS-2126-16	Ø 1,1 mm
18,0 cm, 7"	HS-2126-18	Ø 1,2 mm



FARRELL

12,0 cm, 4 3/4"	HS-2127-12	Ø 0,9 mm
14,0 cm, 5 3/4"	HS-2127-14	Ø 0,9 mm
16,5 cm, 6 1/4"	HS-2127-16	Ø 1,1 mm
18,0 cm, 7"	HS-2127-18	Ø 1,2 mm



HS-2128-01
 Metalletui
 Metal case
 Estuche de metal
 Scatola in metallo

135 x 100 x 25 mm

NABATOFF
HS-2128-00
 komplett
 complete
 completo
 completo



Ø 3,0 mm
HS-2128-03



Ø 6,0 mm
HS-2128-06



Ø 9,0 mm
HS-2128-09



Ø 12,0 mm
HS-2128-12

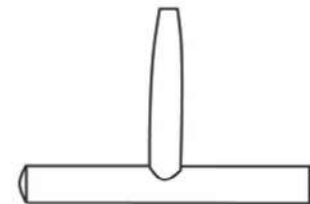

HS-2128-20
 Handgriff
 Handle
 Mango
 Manico



HS-2128-21
 Zugseil
 Cable
 Cable
 Fune

HS-2128-22
 Kunststoff-Sondenspitze
 Plastic probe tip
 Extremidad de sonda de plástico
 Punta in materia plastica



Ø 3,0 mm	HS-2129-30
Ø 3,5 mm	HS-2129-35
Ø 4,0 mm	HS-2129-40
Ø 4,5 mm	HS-2129-45
Ø 5,0 mm	HS-2129-50
Ø 5,5 mm	HS-2129-55
Ø 6,0 mm	HS-2129-60

STANDARD
11,0 cm, 4³/₈"



Ø 3,0 mm	HS-2130-30
Ø 3,5 mm	HS-2130-35
Ø 4,0 mm	HS-2130-40
Ø 4,5 mm	HS-2130-45
Ø 5,0 mm	HS-2130-50
Ø 5,5 mm	HS-2130-55
Ø 6,0 mm	HS-2130-60

STANDARD
12,0 cm, 4³/₄"



Ø 3,0 mm	HS-2131-30
Ø 3,5 mm	HS-2131-35
Ø 4,0 mm	HS-2131-40
Ø 4,5 mm	HS-2131-45
Ø 5,0 mm	HS-2131-50
Ø 5,5 mm	HS-2131-55
Ø 6,0 mm	HS-2131-60

STANDARD
12,0 cm, 4³/₄"



Ø 7,3 mm	HS-2132-07
Ø 8,7 mm	HS-2132-09
Ø 12,0 mm	HS-2132-12

HURWITZ



UNIVERSAL
HS-2132-03



UNIVERSAL
HS-2132-04

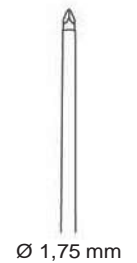
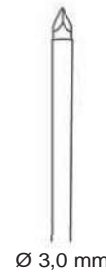
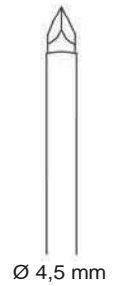
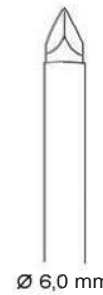

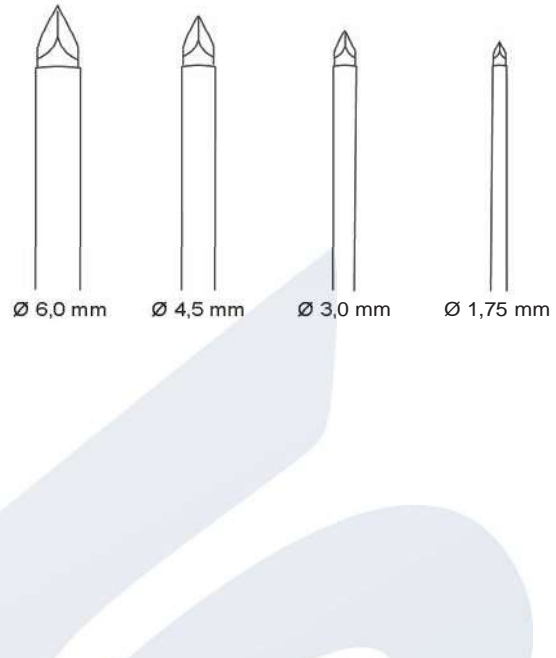
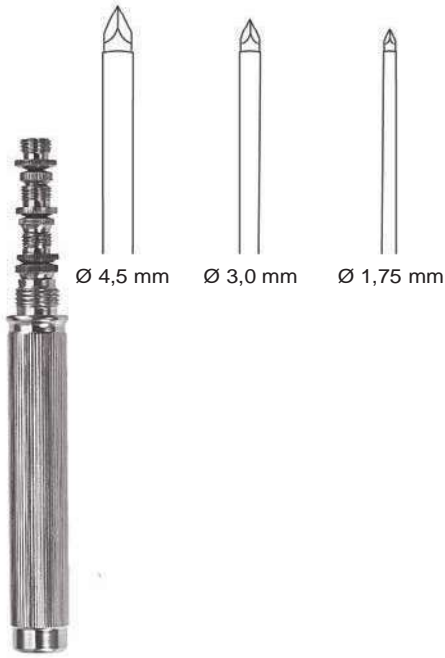

UNIVERSAL
HS-2133-03

UNIVERSAL
HS-2133-04

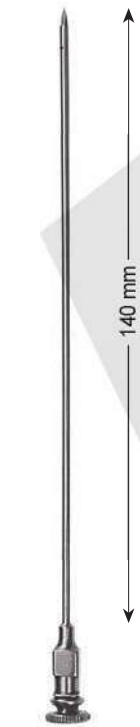

LANDAU
Ø 2,0 mm
HS-2134-16



LANDAU
Ø 2,0 mm
HS-2135-16



DAVIDSON
Ø 6,0 mm
HS-2136-18



BUELAU
Ø 8,0 mm
HS-2137-24



Ø 2,0 mm	HS-2138-20
Ø 2,5 mm	HS-2138-25
Ø 3,0 mm	HS-2138-30

LERMOYEZ



Ø 6,0 mm	HS-2139-06
Ø 8,0 mm	HS-2139-08

CAMPBELL
16,0 cm, 6 1/4"



80 mm

Ø 7,5 mm	HS-2140-01
Ø 9,0 mm	HS-2140-02
Ø 10,5 mm	HS-2140-03
Ø 12,0 mm	HS-2140-04

NELSON
21,0 cm, 8 1/2"



100 mm

Ø 4,0 mm	HS-2141-01
Ø 4,6 mm	HS-2141-02
Ø 5,5 mm	HS-2141-03
Ø 6,5 mm	HS-2141-04

OCHSNER
14,0 cm, 5 1/2"



Record Konus
Record cone

Ø 3,0 mm	HS-2142-30
Ø 4,0 mm	HS-2142-40
Ø 5,0 mm	HS-2142-50

PIERCE
16,0 cm, 6 1/4"

Ø 2,25 mm



COAKLEY
14,0 cm, 5 1/4"
HS-2143-14



Ø 4,0 mm

LICHTWITZ
Kieferhöhlentrokare
Antrum trocars
Trócares para el seno maxilar
Trequarti per puntura del seno mascellare

Ø 3,0 mm HS-2144-30
Ø 4,0 mm HS-2144-40
Ø 5,0 mm HS-2144-50
Ø 5,5 mm HS-2144-55



LICHTWITZ
20,0 cm, 8"
HS-2145-00

LICHTWITZ
11,0 cm, 4 1/2"
HS-2145-00

KRAUSE
16,0 cm, 6 1/4"



DOUGLAS
Ø 3,0 mm
HS-2146-00



POOLE
22,0 cm, 8 5/8"

Ø 6,0 mm HS-2147-06
Ø 10,0 mm HS-2147-10



POOLE
22,0 cm, 8 5/8"

Ø 6,0 mm HS-2148-06
Ø 8,0 mm HS-2148-08



auswechselbare Spitze
interchangeable tip
punta intercambiabile
tipo intercambiabile



COUPLAND
17,0 cm, 6³/₄"
HS-2149-17



Ø 3,5 mm
ST-2149-35



ST-2150-00
Olive allein
Olive only
Oliva suelto
Olivo solo



YANKAUER
27,0 cm, 10⁵/₈"
HS-2150-27



DE BAKEY
27,0 cm, 10⁵/₈"
HS-2151-27



ANTHONY
26,0 cm, 10¹/₄"
HS-2151-26



ANDREWS-PYNCHON
24,0 cm, 9¹/₂"
HS-2151-24



COOLEY
35,0 cm, 13³/₄"
Ø 8,0 mm
HS-2152-02



COOLEY
30,0 cm, 11³/₄"
Ø 7,0 mm
HS-2153-03



COOLEY
31,0 cm, 11³/₄"
Ø 10,0 mm
HS-2154-04



COOLEY
33,0 cm, 13"
Ø 8,0 mm
HS-2155-01

Ø 2,0 mm



COGSWELL
23,0 cm, 9"
HS-2156-23



BYRD
20,0 cm, 8"

Ø 1,5 mm	HS-2157-15
Ø 2,5 mm	HS-2157-25
Ø 3,5 mm	HS-2157-35



HEPP/SCHIEDL
22,5 cm, 8 3/4"
HS-2158-22

Ø 4,0 mm



ADSON
21,0 cm, 8 1/4"
HS-2159-21



MAGILL
17,5 cm, 6 5/8"

Ø 1,0 mm	HS-2160-01
Ø 2,0 mm	HS-2160-02
Ø 3,0 mm	HS-2160-03
Ø 4,0 mm	HS-2160-04



FRAZIER
19,0 cm, 7 1/2"

Charr. 6	HS-2161-06
Charr. 8	HS-2161-08
Charr. 10	HS-2161-10
Charr. 12	HS-2161-12



FERGUSSON
18,0 cm, 7"

Charr. 6	HS-2162-06
Charr. 8	HS-2162-08
Charr. 10	HS-2162-10
Charr. 12	HS-2162-12



POPPE
13,0 cm, 5"

Charr. 6	HS-2163-06
Charr. 8	HS-2163-08
Charr. 10	HS-2163-10
Charr. 12	HS-2163-12



HAGGAI

S U R G I C A L

Galle, Leber, Niere, Blase, Urologie
Gall, Liver, Kidney, Bladder, Urology
Bilis, Hígado, Riñon, Vejiga, Urología
Bile, Fegato, Rene, Vescica, Urologia





HAGGAI

S U R G I C A L

Nierensteinzangen, Gallensteinzangen
 Kidney Stone Forceps, Gall Stone Forceps
 Pinzas para los cálculos renales, Pinzas para los cálculos biliares
 Pinze per calcoli renali, Pinze per calcoli biliari



RANDALL



23,0 cm, 9"
HS-2164-01

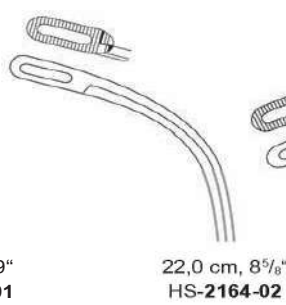

22,0 cm, 8⁵/₈"
HS-2164-02

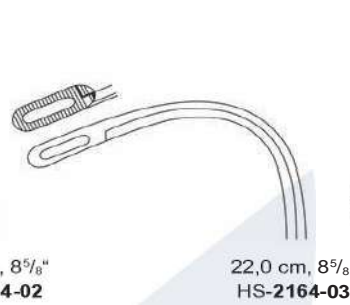

22,0 cm, 8⁵/₈"
HS-2164-03



22,0 cm, 8⁵/₈"
HS-2164-04



19,0 cm, 7¹/₂"
HS-2164-05



19,0 cm, 7¹/₂"
HS-2164-06



DESJARDINS
23,0 cm, 9"



HS-2165-01

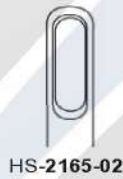

HS-2165-02



MIXTER
22,0 cm, 8⁵/₈"
HS-2166-22



MAYO BLAKE
20,0 cm, 8"
HS-2168-20



20,0 cm, 8"
HS-2169-20



HAGGAI

S U R G I C A L

Gallensteinzangen
Gall Stone Forceps
Pinzas para los cálculos biliares
Pinze per calcoli biliari



BLAKE
20,0 cm, 8"
HS-2170-20

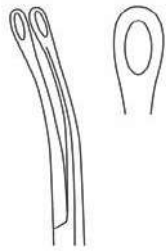

20,0 cm, 8"
HS-2171-20



TURNER-WARWICK
18,0 cm, 7"



HS-2172-01



HS-2173-01



SÖKELAND
24,0 cm, 9½"
HS-2174-24



CZERNY
24,5 cm, 9⅝"
HS-2175-24





LUER-KÖRTE
24,0 cm, 9 1/2"

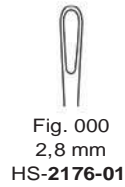

Fig. 000
2,8 mm
HS-2176-01

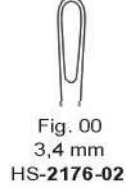

Fig. 00
3,4 mm
HS-2176-02

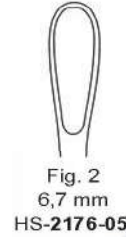

Fig. 2
6,7 mm
HS-2176-05



Fig. 3
8,0 mm
HS-2176-06

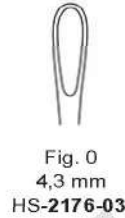

Fig. 0
4,3 mm
HS-2176-03



Fig. 1
5,5 mm
HS-2176-04



Fig. 4
11,0 mm
HS-2176-07



Fig. 5
15,0 mm
HS-2176-08



FERGUSSON
21,5 cm, 8 1/2"
HS-2177-01



MAYO
27,0 cm, 10 5/8"
HS-2178-01

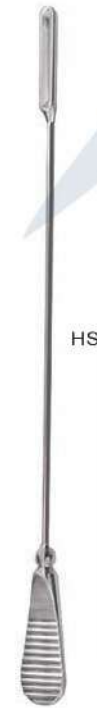

MAYO
27,0 cm, 10 5/8"



HS-2179-01



HS-2179-02



MOYNIHAN
34,0 cm, 13 3/8"
HS-2180-34

Gallengangsonden, Gallengang Dilatatore
 Gall Duct Probes, Common Bile Duct Dilators
 Sonas p. el conducto biliar, Dilatadores para el conducto biliar
 Dilatatori per condotti biliari, Dilatatori per coledoco



MAYO
 32,0 cm, 12 1/2"
 HS-2181-32



OCHSNER
 35,0 cm, 13 3/4"
 HS-2182-35



DESJARDINS
 28,0 cm, 11"



13 Char. HS-2183-13
 18 Char. HS-2183-18
 21 Char. HS-2183-21



MOORE
 30,0 cm, 12"
 HS-2185-30

Gallenblasenlöffel
 Gall bladder scoope
 Cuccharilla para la vesicula biliar
 Cucchiario per colecisti



DESJARDINS
 28,0 cm, 11"

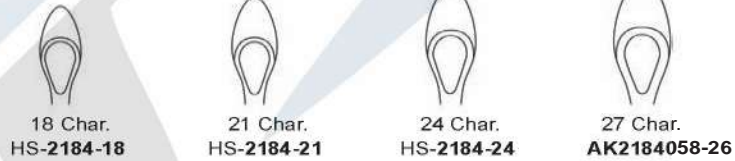

18 Char. HS-2184-18
 21 Char. HS-2184-21
 24 Char. HS-2184-24
 27 Char. AK2184058-26

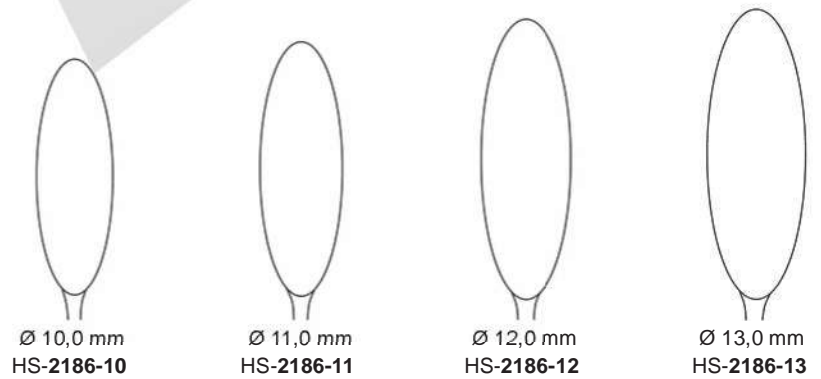
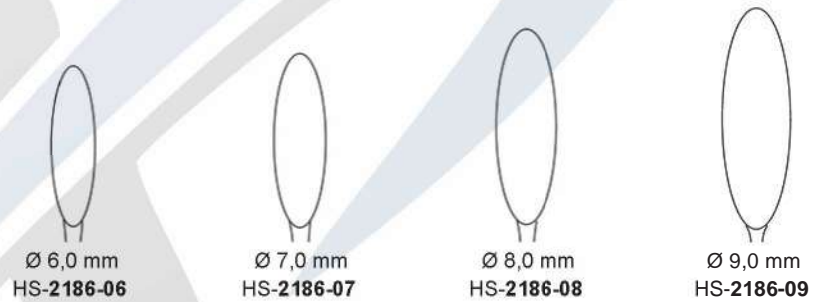



S U R G I C A L

2 x
57 x 25 mm
HS-2188-03

2 x
80 x 25 mm
HS-2188-04

120 x 45 mm
HS-2188-02

HS-2188-01

THOMSON-WALKER
HS-2187-00

MILLIN
HS-2188-00

110 mm

73 x 28 mm

95 mm

27 x 60 mm

80 x 31 mm

JUDD-MASSON
HS-2189-00

LEGUEU
HS-2190-00



MILLIN
 23,0 cm, 9"
 HS-2191-23

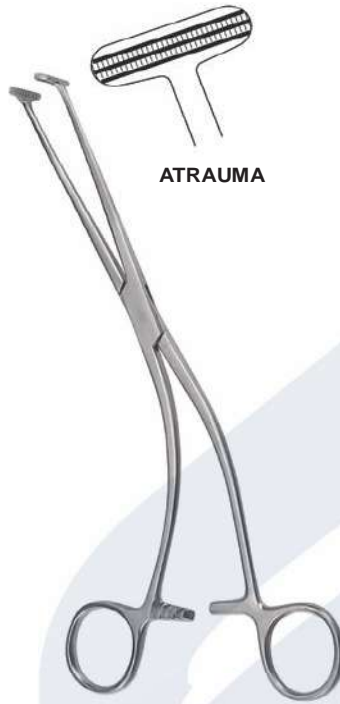

ATRAUMA

MILLIN
 24,0 cm, 9½"
 HS-2192-24



MILLIN
 24,0 cm, 9½"
 HS-2193-24

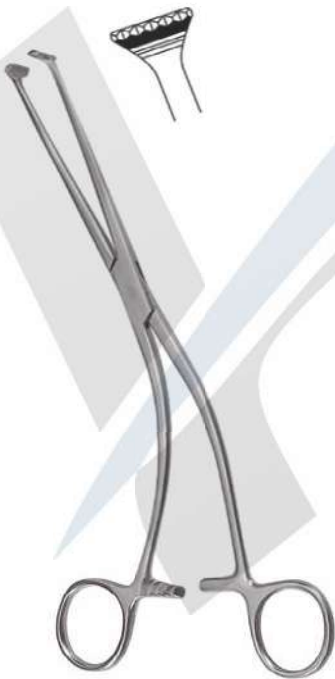

MILLIN
 23,0 cm, 9"
 HS-2195-23



MILLIN
 28,5 cm, 11¼"
 HS-2196-24

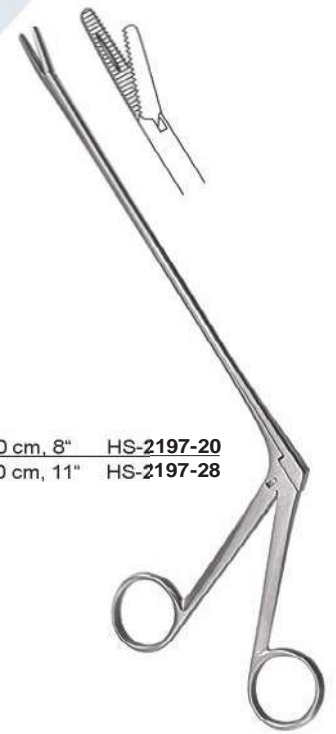

20,0 cm, 8" HS-2197-20
 28,0 cm, 11" HS-2197-28

MATHIEU



HAGGAI

S U R G I C A L

Prostatahaken, Blasenspatel
Prostatic Retractors, Bladder Retractor
Separadores para la prostata, Separadores vesicales
Retrattori prostatici, Divaricatori vescicali



YOUNG
21,0 cm, 8¹/₄"
HS-2198-21



YOUNG
22,0 cm, 8⁵/₈"
HS-2199-22



YOUNG
21,0 cm, 8¹/₄"
HS-2200-21



YOUNG
22,0 cm, 8⁵/₈"
HS-2201-22



90 x 35 mm

LEGUEU
26,0 cm, 10¹/₄"
HS-2202-26



90 x 61 mm

KOCHER
23,5 cm, 9¹/₄"
HS-2203-23



für Männer
for men
para hombres
per uomini

29,0 cm, 11 1/2"

Char. 8	HS-2204-08
Char. 10	HS-2204-10
Char. 12	HS-2204-12
Char. 14	HS-2204-14
Char. 16	HS-2204-16
Char. 18	HS-2204-18
Char. 20	HS-2204-20
Char. 22	HS-2204-22
Char. 24	HS-2204-24



für Frauen
for women
para mujeres
per donne

16,0 cm, 6 1/4"

Char. 6	HS-2205-06
Char. 7	HS-2205-07
Char. 8	HS-2205-08
Char. 9	HS-2205-09
Char. 10	HS-2205-10
Char. 11	HS-2205-11
Char. 12	HS-2205-12
Char. 13	HS-2205-13
Char. 14	HS-2205-14
Char. 15	HS-2205-15
Char. 16	HS-2205-16
Char. 18	HS-2205-18
Char. 20	HS-2205-20
Char. 24	HS-2205-24



STRAUSS
11,0 cm, 4 1/5"
HS-2207-11



STOCKMANN
8,0 cm, 3 1/4"
HS-2208-08



COMCO

Ø 8,0 mm	HS-2206-08
Ø 11,0 mm	HS-2206-11
Ø 13,0 mm	HS-2206-13
Ø 16,0 mm	HS-2206-16
Ø 21,0 mm	HS-2206-21
Ø 26,0 mm	HS-2206-26
Ø 32,0 mm	HS-2206-32

Magen, Darm, Mastdarm
Stomach, Intestines, Rectum
Estómago, Intestino, Recto
Stomaco, Intestino, Retto



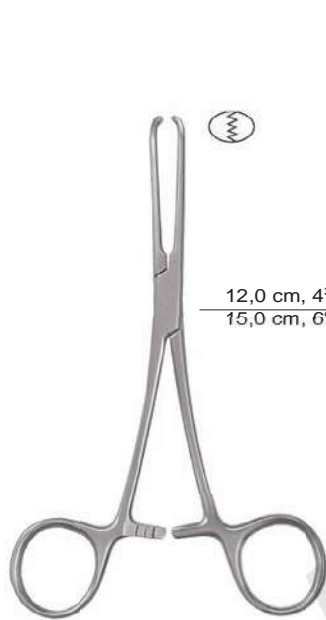

12,0 cm, 4³/₄" HS-2208-12
15,0 cm, 6" HS-2208-15

ALLIS-BABY



15,0 cm, 6" HS-2209-15
19,0 cm, 7¹/₂" HS-2209-19
25,0 cm, 9³/₄" HS-2209-25

ALLIS

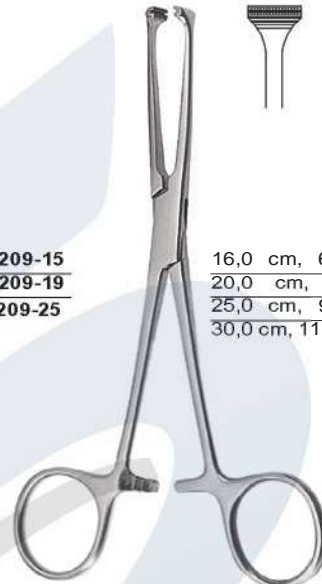

16,0 cm, 6¹/₄" HS-2210-16
20,0 cm, 8" HS-2210-20
25,0 cm, 9³/₄" HS-2210-25
30,0 cm, 11³/₄" HS-2210-30

ALLIS-ATRAUMA



15,5 cm, 6" HS-2211-15
20,0 cm, 8" HS-2211-20
23,0 cm, 9" HS-2211-23

ALLEN



12,5 cm, 5" HS-2212-12
15,0 cm, 6" HS-2212-15
19,5 cm, 7³/₄" HS-2212-19

LANE

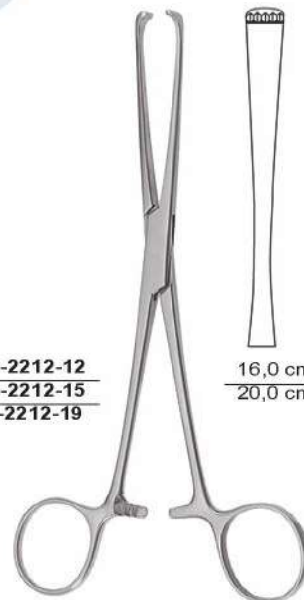

16,0 cm, 6¹/₄" HS-2213-16
20,0 cm, 8" HS-2213-20

LOCKWOOD-ALLIS



HAGGAI

S U R G I C A L

Darm- und Gewebefaßzangen
Intestinal and Tissue Grasping Forceps
Pinzas intestinales y para tejidos
Pinze da presa per intestino e tessuti



JUDD-ALLIS



LITTLEWOOD
18,5 cm, 7 1/4"
HS-2215-16



ALLIS-ADAIR
15,5 cm, 6"
HS-2216-15



BOYS-ALLIS
15,5 cm, 6"
HS-2217-15



THOMS-ALLIS
20,0 cm, 8"
HS-2218-20



ALLIS
20,0 cm, 8"
HS-2219-20



HAGGAI

S U R G I C A L

Darm- und Gewebefäßzangen
Intestinal and Tissue Grasping Forceps
Pinzas intestinales y para tejidos
Pinze da presa per intestino e tessuti



LOCKWOOD
20,0 cm, 8"
HS-2220-20



WILLIAMS
16,0 cm, 6 1/4"
HS-2221-16

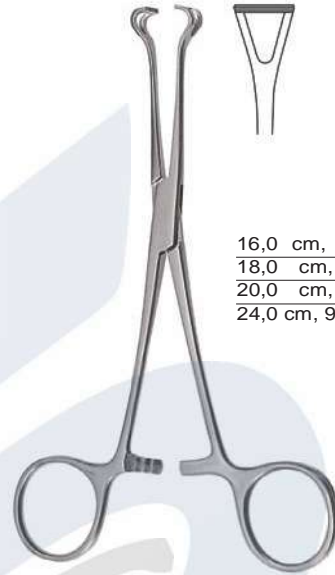

BABCOCK

16,0 cm, 6 1/4" HS-2222-16
18,0 cm, 7" HS-2222-18
20,0 cm, 8" HS-2222-20
24,0 cm, 9 1/2" HS-2222-24



BABCOCK-ATRAUMA

16,0 cm, 6 1/4" HS-2223-16
20,0 cm, 8" HS-2223-20



BABCOCK-TC

16,0 cm, 6 1/4" HS-2224-16
20,0 cm, 8" HS-2224-20



DUVAL-TC
20,0 cm, 8"
HS-2225-20



DUVAL

18,0 cm, 7"	HS-2226-18
20,0 cm, 8"	HS-2226-20 HS-2227-20
23,0 cm, 9"	HS-2227-23

Darm- und Gewebefaßzangen
Intestinal and Tissue Grasping Forceps
Pinzas intestinales y para tejidos
Pinze da presa per intestino e tessuti

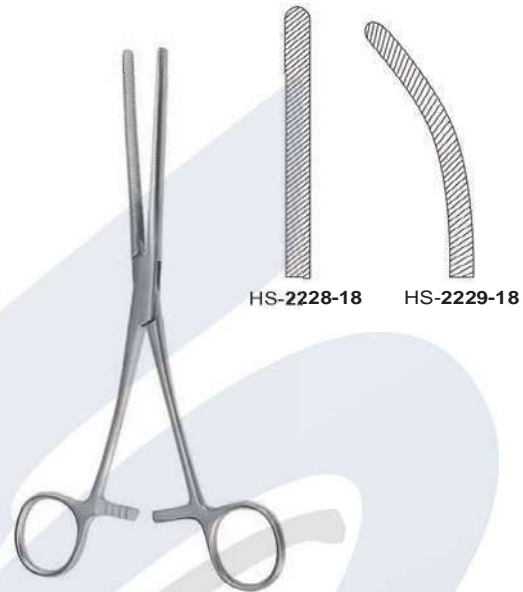
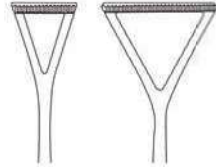

BABY-DOYEN
18,0 cm, 7"

HS-2228-18 HS-2229-18



DOYEN

21,0 cm, 8 1/4"	HS-2230-21
23,0 cm, 9"	HS-2230-23

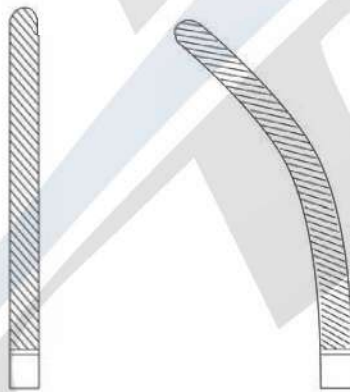



DOYEN



21,0 cm, 8¹/₄" HS-2232-21
23,0 cm, 9" HS-2232-23



21,0 cm, 8¹/₄" HS-2233-21
23,0 cm, 9" HS-2233-23

mit atraumatischer Zahnung
with atraumatic serration
con bacos atraumáticos
con morsi atraumatici



KOCHER



22,0 cm, 8⁵/₈" HS-2234-22
25,0 cm, 9³/₄" HS-2234-25
28,0 cm, 11" HS-2234-28



22,0 cm, 8⁵/₈" HS-2235-22
25,0 cm, 9³/₄" HS-2235-25
28,0 cm, 11" HS-2235-28



mit atraumatischer Zahnung
with atraumatic serration
con bacos atraumáticos
con morsi atraumatici

KOCHER



22,0 cm, 8⁵/₈" HS-2236-22
25,0 cm, 9³/₄" HS-2236-25
28,0 cm, 11" HS-2236-28



22,0 cm, 8⁵/₈" HS-2237-22
25,0 cm, 9³/₄" HS-2237-25
28,0 cm, 11" HS-2237-28



MAYO-ROBSON



21,0 cm, 8¹/₄" HS-2238-21
23,0 cm, 9" HS-2238-23
25,0 cm, 9³/₄" HS-2238-25



21,0 cm, 8¹/₄" HS-2239-21
23,0 cm, 9" HS-2239-23
25,0 cm, 9³/₄" HS-2239-25



MAYO-ROBSON

21,0 cm, 8 1/4"	HS-2240-21
23,0 cm, 9"	HS-2240-23
25,0 cm, 9 3/4"	HS-2240-25

mit atraumatischer Zahnung
with atraumatic serration
con bacos atraumáticas
con morsi atraumatici



21,0 cm, 8 1/4"	HS-2241-21
23,0 cm, 9"	HS-2241-23
25,0 cm, 9 3/4"	HS-2241-25

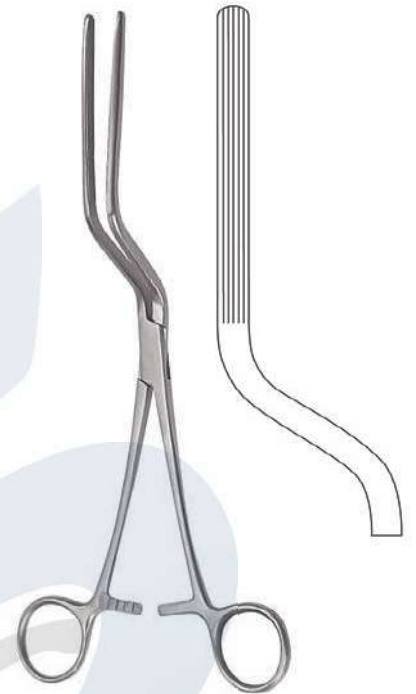

BRUNNER
24,0 cm, 9 1/2"
HS-2242-24

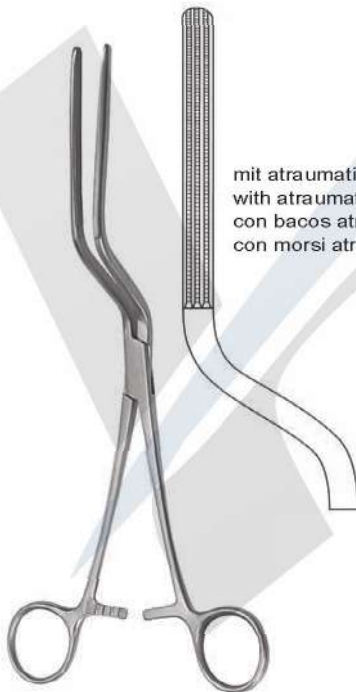

mit atraumatischer Zahnung
with atraumatic serration
con bacos atraumáticas
con morsi atraumatici



GLASSMAN
23,0 cm, 9"
HS-2244-23



GLASSMAN
23,5 cm, 9 1/4"
HS-2245-23



Maullänge
length of jaws
longitud de la boca
bocche lungh.

5,0 cm, 2" HS-2246-05
7,0 cm, 2 1/2" HS-2246-07
10,0 cm, 4" HS-2246-10

DE MARTEL-WOLFSON



DE MARTEL-WOLFSON
8,5 cm, 3 1/2"
HS-2247-08



DE MARTEL-WOLFSON
26,0 cm, 10 1/4"
HS-2248-26



BABY-PAYR
15,0 cm, 6"



HS-2249-15
mit Stift
with pin
con espiga
con perno



HS-2250-15
ohne Stift
without pin
sin espiga
senza perno



PAYR



21,0 cm, 8 1/4" HS-2252-21
29,0 cm, 11 1/2" HS-2252-29



mit Stift
with pin
con espiga
con perno

ohne Stift
without pin
sin espiga
senza perno

Darm- und Magenklappen
 Intestinal and Stomach Clamp Forceps
 Pinzas-clamps intestinales y estomacales
 Pinze per intestino e stomaco



HS-2254-30

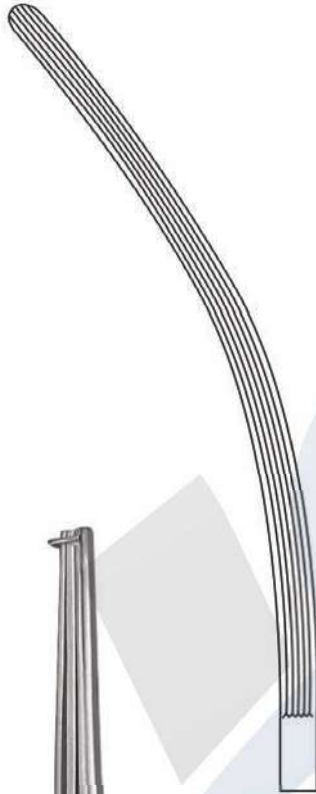

HS-2255-30



HS-2256-33



HS-2257-33

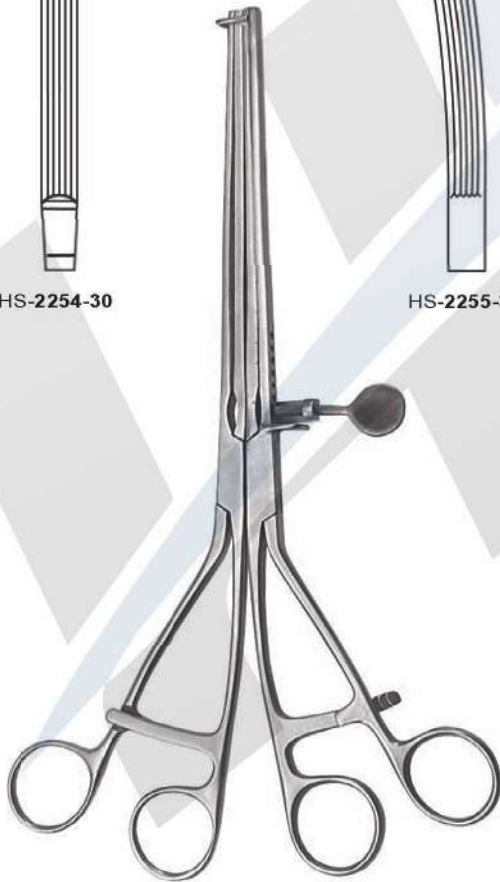

LANE
 30,0 cm, 11³/₄"

mit atraumatischer Zahnung
 with atraumatic serration
 con bacos atraumáticos
 con morsi atraumatici



SCUDDER
 33,0 cm, 13"



HAGGAI

S U R G I C A L

Rektum-Anastomosenklemmen
Sigmoid Anastomosis Forceps
Pinzas para anastomosis de recto
Pinze per anastomosi de recto



MIKULICZ
19,0 cm, 7 1/2"
HS-2258-19

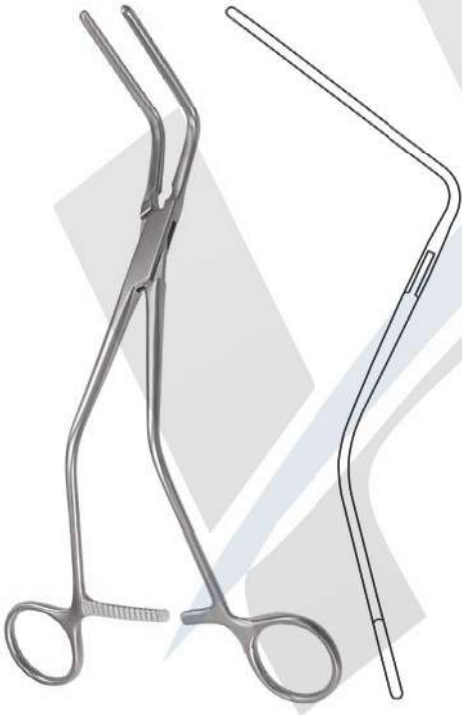

HAYES

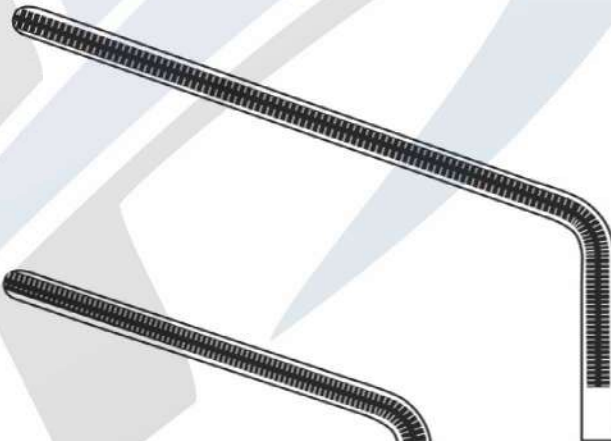

HS-2260-28
28,0 cm, 11"

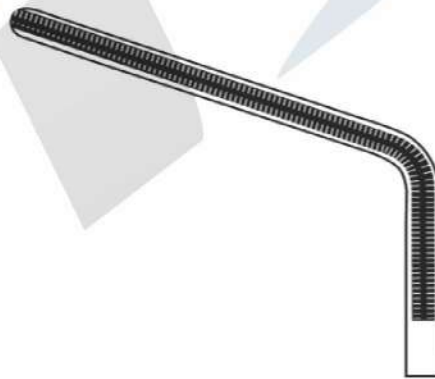

HS-2259-26
26,0 cm, 10"

17 x 89 mm



SIMS
15,0 cm, 6"
HS-2261-15

17 x 89 mm



SIMS
15,0 cm, 6"
HS-2262-15

25 x 89 mm



MATHIEU
21,0 cm, 8 1/4"
HS-2263-21

75 x 23 mm



SMITH-BUIE
15,0 cm, 6"
HS-2264-15

Anal spreizer, Sphinkteroskope, Anuskope
Rectal Retractor, Sphincteroscopes, Anoscope
Separadores para el recto, Esfinteroscopios, Anoscopios
Dilatatori per l'ano ed il retti, Sfinteroscopi, Anoscopi

22 x 75 mm
HS-2265-75

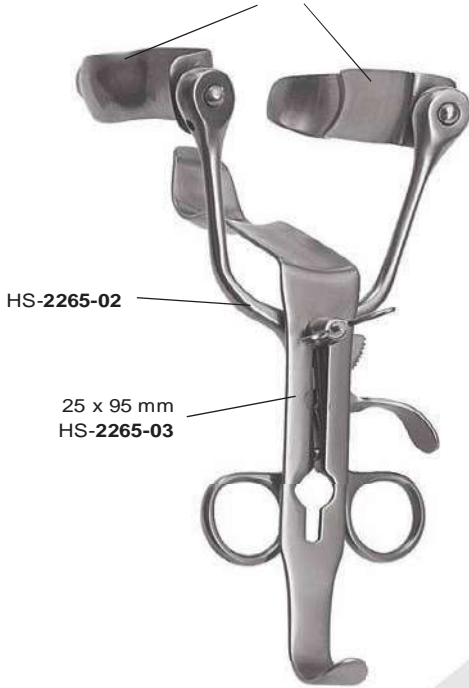

ALAN PARKS
 13,5 cm, 5³/₈"
HS-2265-00

22 x 95 mm
HS-2265-95



Kaltlichtkammer für Proktoskope
Cold-light clip for proctoscopes
Clip para luz fría con proctoscopios
Clip per luce fredda con protoscopi



HS-2266-00



Ø 22 x 50 mm HS-2267-01
 Ø 22 x 100 mm HS-2267-02
 Ø 22 x 145 mm HS-2267-03
 Ø 22 x 200 mm HS-2267-04
 Ø 21 x 50 mm HS-2267-05
 Ø 27 x 50 mm HS-2267-06

HAYES



Ø 16 x 65 mm HS-2268-01
 Ø 19 x 65 mm HS-2268-02
 Ø 22 x 65 mm HS-2268-03
 Ø 22 x 130 mm HS-2268-04

HIRSCHMANN



Ø 22 x 65 mm HS-2269-22
Ø 30 x 65 mm HS-2269-30

CHELSEA EATON



ohne Kaltlichtträger
without cold light carrier
sin portador para luz fría
senza luce fredda

IVES FANSLER
Ø 22 mm
HS-2270-01

mit Kaltlichtträger
with cold light carrier
con portador para luz fría
con luce fredda

IVES FANSLER
Ø 22 mm
HS-2271-02



Ø 17 x 65 mm HS-2272-01
Ø 17 x 80 mm HS-2272-02
Ø 20 x 65 mm HS-2272-03
Ø 20 x 80 mm HS-2272-04
Ø 24 x 65 mm HS-2272-05
Ø 24 x 80 mm HS-2272-06

MORGAN



055-1000-02



Ø 25 x 65 mm HS-2273-25
Ø 29 x 65 mm HS-2273-29
Ø 38 x 70 mm HS-2273-38

FANSLER

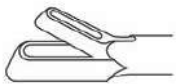
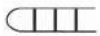

28,0 cm, 11" HS-2274-28
35,0 cm, 13³/₄" HS-2274-35
42,0 cm, 16¹/₂" HS-2274-42



28,0 cm, 11" HS-2275-28
35,0 cm, 13³/₄" HS-2275-35
42,0 cm, 16¹/₂" HS-2275-42

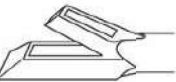
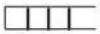

28,0 cm, 11" HS-2276-28
35,0 cm, 13³/₄" HS-2276-35
42,0 cm, 16¹/₂" HS-2276-42



28,0 cm, 11" HS-2277-28
35,0 cm, 13³/₄" HS-2277-35
42,0 cm, 16¹/₂" HS-2277-42



RUDD
HS-2280-00

Hämorrhoiden-Ligator mit Ladekonus
Haemorrhoidal ligator with loading attachment
Ligador para hemorroides con cono de carga
Legatori ermorroidali con carica a cono



MC GIVNEY
HS-2281-00

Hämorrhoiden-Ligator mit Ladekonus
Haemorrhoidal ligator with loading attachment
Ligador para hemorroides con cono de carga
Legatori ermorroidali con carica a cono



MC GIVNEY
19,0 cm, 7 1/2"
HS-2282-19



MC GIVNEY
19,0 cm, 7 1/2"
HS-2283-19



PRATT
21,0 cm, 8 1/4"



HS-2284-01



HS-2284-02



HS-2284-03

Gynäkologie, Geburtshilfe
Gynecology, Obstetrics
Ginecología, Obstetricia
Ginecologia, Ostetricia



für Kinder
for children
para niños
per bambini



COLLIN
65 x 10 mm
HS-2285-00

für Jungfrauen
for virgins
para virgenes
per vergini



COLLIN
65 x 10 mm
HS-2286-00



COLLIN

85 x 30 mm	HS-2287-01
100 x 35 mm	HS-2287-02
110 x 40 mm	HS-2287-03



CUSCO

80 x 24 mm	HS-2288-01
80 x 32 mm	HS-2288-02
98 x 16 mm	HS-2288-03
105 x 25 mm	HS-2288-04
107 x 29 mm	HS-2288-05
115 x 35 mm	HS-2288-06

zentrale Stellschraube
central fixation screw
tornillo de sujeto central
vite di regolazione centrale



CUSCO

75 x 32 mm	HS-2289-01
85 x 36 mm	HS-2289-02
95 x 37 mm	HS-2289-03

seitliche Stellschraube
lateral fixation screw
tornillo de sujeto lateral
vite di regolazione laterale



für Jungfrauen
for virgins
para vírgenes
per vergini

CUSCO

75 x 17 mm	HS-2290-00
------------	------------

seitliche Stellschraube
lateral fixation screw
tornillo de sujeto lateral
vite di regolazione laterale



CUSCO

75 x 32 mm	HS-2291-01
85 x 35 mm	HS-2291-02
100 x 35 mm	HS-2291-03

Schweizer Modell
Swiss pattern
Modelo suizo
Modello svizzero



CUSCO

90 x 23-25 mm	HS-2292-01
100 x 25-27 mm	HS-2292-02
110 x 27-30 mm	HS-2292-03



GRAVE

75 x 20 mm	HS-2293-01
95 x 35 mm	HS-2293-02
115 x 35 mm	HS-2293-03



PEDERSON

75 x 13 mm	HS-2294-01
100 x 22 mm	HS-2294-02
120 x 25 mm	HS-2294-03



SEMM

90 x 14-18 mm	HS-2295-01
100 x 17-20 mm	HS-2295-02
100 x 25-30 mm	HS-2295-03



WEISSBARTH
21,0 cm, 8 1/4"
HS-2296-00



mit abnehmbarem Gewicht
with detachable weight
con peso desmontable
con peso smontabile

1,14 kg

AUVARD
75 x 38 mm
HS-2297-00



mit festem Gewicht
with fixed weight
con peso fijo
con peso fisso

1,14 kg

AUVARD
75 x 38 mm
HS-2298-00



HS-2299-03

400 g
HS-2299-40

800 g
HS-2299-80

SCHERBACK
HS-2299-00

koplett, complete, completo, completo



80 x 30 mm
HS-2299-04

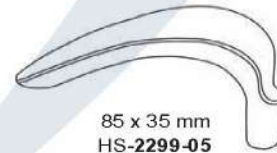

85 x 35 mm
HS-2299-05

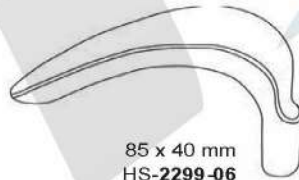

85 x 40 mm
HS-2299-06

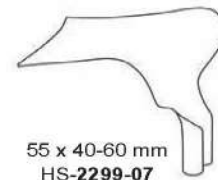

55 x 40-60 mm
HS-2299-07

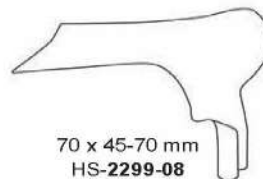

70 x 45-70 mm
HS-2299-08



Satz
Set
Juego
Set

KRISTELLER
Fig. 1 HS-2300-01
Fig. 2 HS-2300-02
Fig. 3 HS-2300-03



Spekula allein, flach
Specula only, flat hollow
Espéculos suelto, con huecos planos
Solo speculi, piatta

KRISTELLER
105 x 26 mm HS-2301-01
105 x 28 mm HS-2301-02
105 x 33 mm HS-2301-03



Halter allein
Retractors only
Valvas suelto
Solo valve

KRISTELLER
115 x 22 mm HS-2302-01
115 x 24 mm HS-2302-02
115 x 29 mm HS-2302-03



Satz
Set
Juego
Set

KRISTELLER
Fig. 1 HS-2303-01
Fig. 2 HS-2303-02
Fig. 3 HS-2303-03



Spekula allein, flach
Specula only, flat hollow
Espéculos suelto, con huecos planos
Solo speculi, piatta

KRISTELLER
110 x 27 mm HS-2304-01
110 x 30 mm HS-2304-02
110 x 36 mm HS-2304-03

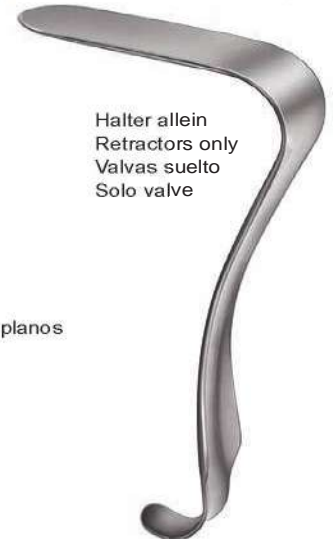

Halter allein
Retractors only
Valvas suelto
Solo valve

KRISTELLER
115 x 23 mm HS-2305-01
115 x 26 mm HS-2305-02
115 x 32 mm HS-2305-03



Satz
Set
Juego
Set

KRISTELLER

- Fig. 0 HS-2306-00
- Fig. 1 HS-2306-01
- Fig. 2 HS-2306-02
- Fig. 3 HS-2306-03



Spekula allein
Specula only
Espéculos suelto
Solo speculi

KRISTELLER

- 70 x 15 mm HS-2307-00
- 70 x 27 mm HS-2307-01
- 80 x 30 mm HS-2307-02
- 90 x 36 mm HS-2307-03



Halter allein
Retractors only
Valvas suelto
Solo valve

KRISTELLER

- 75 x 10 mm HS-2308-00
- 75 x 23 mm HS-2308-01
- 85 x 26 mm HS-2308-02
- 100 x 32 mm HS-2308-03



konisch, für Jungfrauen
conical blades, for virgins
valvos cónicos, para vírgenes
valve coniche, per vergini

Satz
Set
Juego
Set

KRISTELLER

- Fig. 00 HS-2309-01
- Fig. 0 HS-2309-02



Spekula allein
Specula only
Espéculos suelto
Solo speculi

KRISTELLER

- 105 x 18 mm HS-2310-01
- 105 x 21 mm HS-2310-02



Halter allein
Retractors only
Valvas suelto
Solo valve

KRISTELLER

- 110 x 14 mm HS-2311-01
- 110 x 17 mm HS-2311-02



leicht hohl
slightly-concave
ligeremente concavos
leggeremente concavi

DOYEN
23,0 cm, 9"

Fig	a x b	
1	55 x 35 mm	HS-2312-01
2	85 x 35 mm	HS-2312-02
3	115 x 35 mm	HS-2312-03

1	55 x 45 mm	HS-2313-01
2	85 x 45 mm	HS-2313-02
3	115 x 45 mm	HS-2313-03
4	160 x 45 mm	HS-2313-04

1	55 x 60 mm	HS-2314-01
2	85 x 60 mm	HS-2314-02
3	115 x 60 mm	HS-2314-03
4	160 x 60 mm	HS-2314-04



halb-hohl
medium-concave
semi-concavos
semi-concavi

DOYEN
23,0 cm, 9"

Fig	a x b	
1	55 x 35 mm	HS-2315-01
2	85 x 35 mm	HS-2315-02
3	115 x 35 mm	HS-2315-03

1	55 x 45 mm	HS-2316-01
2	85 x 45 mm	HS-2316-02
3	115 x 45 mm	HS-2316-03

1	55 x 60 mm	HS-2317-01
2	85 x 60 mm	HS-2317-02
3	115 x 60 mm	HS-2317-03



Satz
Set
Juego
Set

KALLMORGEN
70 x 40 mm HS-2318-01
90 x 40 mm HS-2318-02



Spekula allein
Specula only
Espéculos suelto
Solo speculi

KALLMORGEN
70 x 40 mm HS-2319-01
90 x 40 mm HS-2319-02



Halter allein
Retractors only
Valvas suelto
Solo valve

KALLMORGEN
70 x 40 mm HS-2320-01
90 x 40 mm HS-2320-02



70 x 15 mm

KRISTELLER
17,0 cm, 6³/₄"
HS-2321-17



75 x 39 mm

KALLMORGEN
17,0 cm, 6³/₄"
HS-2322-17



JACKSON
75 x 38 mm HS-2323-01
90 x 38 mm HS-2323-02
100 x 38 mm HS-2323-03

76 x 25 mm



70 x 22 mm

BREISKY
14,0 cm, 5½"
HS-2324-01

82 x 30 mm



76 x 25 mm

BREISKY
14,0 cm, 5½"
HS-2324-02

95 x 38 mm



82 x 30 mm

BREISKY
17,0 cm, 6¾"
HS-2324-03

102 x 44 mm



95 x 38 mm

BREISKY
17,0 cm, 6¾"
HS-2324-04



SIMS
GO-1294-00
Satz, Set, Juego, Set



70 x 30 mm

65 x 25 mm

SIMS
12,5 cm, 5"
HS-2325-01



70 x 35 mm

70 x 30 mm

SIMS
15,0 cm, 6"
HS-2325-02



90 x 40 mm

85 x 35 mm

SIMS
17,5 cm, 7"
HS-2325-03



Spekula allein
Specula only
Especulos suelto
Solo speculi

MATHIEU
100 x 13-23 mm HS-2326-01
100 x 16-30 mm HS-2326-02



Halter allein
Retractors only
Valvas suelto
Solo valve

MATHIEU
100 x 11-21 mm HS-2327-01
100 x 14-27 mm HS-2327-02



LANDAU
100 x 28 mm HS-2328-01
100 x 38 mm HS-2328-02



BREISKY

100 x 20 mm HS-2329-20
100 x 25 mm HS-2329-25
100 x 30 mm HS-2329-30
100 x 35 mm HS-2329-35
100 x 40 mm HS-2329-40

130 x 20 mm HS-2330-20
130 x 25 mm HS-2330-25
130 x 30 mm HS-2330-30
130 x 35 mm HS-2330-35
130 x 40 mm HS-2330-40

155 x 40 mm HS-2330-40



MATZENAUER

90 x 20 mm HS-2331-20

100 x 10 mm HS-2331-10
100 x 20 mm HS-2331-20
100 x 25 mm HS-2331-25

125 x 15 mm HS-2332-15
125 x 20 mm HS-2332-20
125 x 25 mm HS-2332-25
125 x 30 mm HS-2332-30
125 x 35 mm HS-2332-35
125 x 40 mm HS-2332-40



85 x 17 mm

BRAUN, MODIF.
19,0 cm, 7½"
HS-2333-19



60 x 30 mm

DOYEN
23,0 cm, 9"
HS-2333-23



80 x 30 mm

DOYEN
25,0 cm, 9"
HS-2333-25



95 x 38 mm

WERTHEIM
30,0 cm, 12"
HS-2333-30



HAGGAI

S U R G I C A L

Endospekula, Lateral-Spekulum, Intrauterinsonde
Endospecula, Lateral Speculum, Intrauterine Probe
Endospecúlos, Espéculo lateral, Sonda intra-uterina
Endospeculi, Speculo lateral, Sonde intrauterine



KOGAN
24,0 cm, 9 1/2"



KOGAN
24,0 cm, 9 1/2"



Lateral-Spekulum
Lateral speculum
Espécula lateral
Speculo lateral

25,0 cm, 10"
HS-2336-25

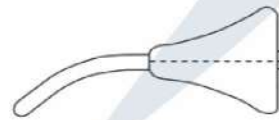

COHEN
HS-2337-01

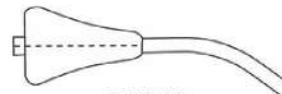

COHEN
HS-2337-02



COHEN
HS-2337-00



HEGAR
18,5 cm, 7 1/4"

Ø 1,0 mm	HS-2338-01
Ø 2,0 mm	HS-2338-02
Ø 3,0 mm	HS-2338-03
Ø 4,0 mm	HS-2338-04
Ø 5,0 mm	HS-2338-05
Ø 6,0 mm	HS-2338-06
Ø 7,0 mm	HS-2338-07
Ø 8,0 mm	HS-2338-08
Ø 9,0 mm	HS-2338-09
Ø 10,0 mm	HS-2338-10
Ø 11,0 mm	HS-2338-11
Ø 12,0 mm	HS-2338-12
Ø 13,0 mm	HS-2338-13
Ø 14,0 mm	HS-2338-14
Ø 15,0 mm	HS-2338-15
Ø 16,0 mm	HS-2338-16
Ø 17,0 mm	HS-2338-17
Ø 18,0 mm	HS-2338-18
Ø 19,0 mm	HS-2338-19
Ø 20,0 mm	HS-2338-20
Ø 21,0 mm	HS-2338-21
Ø 22,0 mm	HS-2338-22
Ø 23,0 mm	HS-2338-23
Ø 24,0 mm	HS-2338-24
Ø 25,0 mm	HS-2338-25
Ø 26,0 mm	HS-2338-26



HEGAR
18,5 cm, 7 1/4"

Ø 1,5 mm	HS-2339-01
Ø 2,5 mm	HS-2339-02
Ø 3,5 mm	HS-2339-03
Ø 4,5 mm	HS-2339-04
Ø 5,5 mm	HS-2339-05
Ø 6,5 mm	HS-2339-06
Ø 7,5 mm	HS-2339-07
Ø 8,5 mm	HS-2339-08
Ø 9,5 mm	HS-2339-09
Ø 10,5 mm	HS-2339-10
Ø 11,5 mm	HS-2339-11
Ø 12,5 mm	HS-2339-12
Ø 13,5 mm	HS-2339-13
Ø 14,5 mm	HS-2339-14
Ø 15,5 mm	HS-2339-15
Ø 16,5 mm	HS-2339-16
Ø 17,5 mm	HS-2339-17



205 x 105 x 45 mm

HEGAR
HS-2340-99
Satz, Set, Juego, Set
Ø 1,0 - Ø 26,0
(26 dilators)

HEGAR
HS-2340-98
Satz, Set, Juego, Set
Ø 4,0 - Ø 17,0
(14 dilators)



HEGAR
20,0 cm, 8"

1,0 / 2,0 mm	HS-2341-01
Ø 3,0 / 4,0 mm	HS-2341-03
Ø 5,0 / 6,0 mm	HS-2341-05
Ø 7,0 / 8,0 mm	HS-2341-07
Ø 9,0 / 10,0 mm	HS-2341-09
Ø 11,0 / 12,0 mm	HS-2341-11
Ø 13,0 / 14,0 mm	HS-2341-13
Ø 15,0 / 16,0 mm	HS-2341-15
Ø 17,0 / 18,0 mm	HS-2341-17
Ø 19,0 / 20,0 mm	HS-2341-19
Ø 21,0 / 22,0 mm	HS-2341-21
Ø 23,0 / 24,0 mm	HS-2341-23
Ø 25,0 / 26,0 mm	HS-2341-25



HEGAR
HS-2342-98
Satz, Set, Juego, Set
Ø 3,0 / 4,0 - Ø 17,0 / 18,0 mm
(8 dilators)

HEGAR
HS-2343-99
Satz, Set, Juego, Set
Ø 1,0 / 2,0 - Ø 25,0 / 26,0 mm
(13 dilators)



HANK

Ø 4,5 / 5,0 mm	HS-2344-05
Ø 5,5 / 6,0 mm	HS-2344-06
Ø 6,5 / 7,0 mm	HS-2344-07
Ø 7,5 / 8,0 mm	HS-2344-08
Ø 8,5 / 9,0 mm	HS-2344-09
Ø 9,5 / 10,0 mm	HS-2344-10



HANK
HS-2345-98
Satz, Set, Juego, Set
Ø 4,5 / 5,0 - Ø 9,5 / 10,0 mm
(6 dilators)



HAGGAI

S U R G I C A L

Uterus-Dilatatoren, Hakenzangen
Uterine Dilators, Uterine Tenaculum Forceps
Dilatadores uterinos, Pinzas para coger el cuello del útero
Dilatatori uterini, Pinze per abbassare il collo dell'utero



PRATT

Ø 4,5 / 5,0 mm	HS-2346-05
Ø 5,5 / 6,0 mm	HS-2346-06
Ø 7,5 / 8,0 mm	HS-2346-08
Ø 8,5 / 9,0 mm	HS-2346-09
Ø 9,5 / 10,0 mm	HS-2346-10
Ø 11,5 / 12,0 mm	HS-2346-12
Ø 12,5 / 13,0 mm	HS-2346-13
Ø 13,5 / 14,0 mm	HS-2346-14



PRATT
HS-2347-98
Satz, Set, Juego, Set
Ø 4,5 / 5,0 - Ø 13,5 / 14,0 mm
(8 dilators)



BARRETT
18,0 cm, 7"
HS-2348-18



ADAIR
19,0 cm, 7½"
HS-2349-19



STAUDE-MOORE
17,0 cm, 6¾"
HS-2350-17

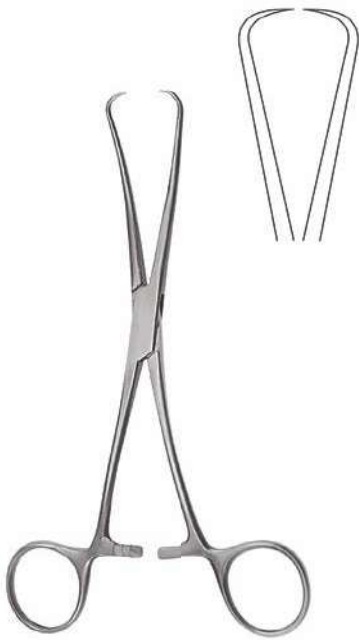

JARCHO
20,0 cm, 8"
HS-2351-20



SCHROEDER
25,0 cm, 9³/₄"
HS-2352-25

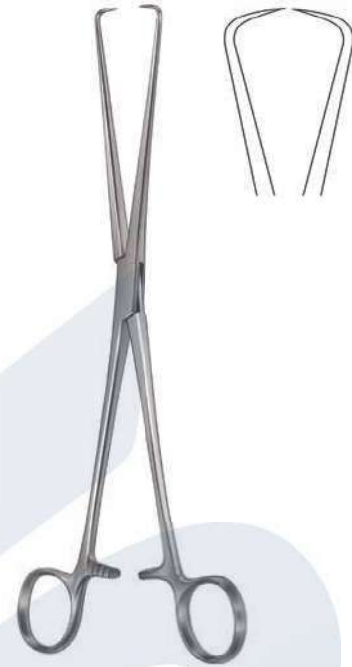

BRAUN
25,0 cm, 9³/₄"
HS-2353-25



DUPLAY
28,0 cm, 11"
HS-2354-28



POZZI
26,0 cm, 10¹/₄"
HS-2355-26



KAHN
24,0 cm, 9¹/₂"
HS-2356-24



SKENE
24,0 cm, 9½"
HS-2357-24



SCHROEDER
24,0 cm, 9½"
HS-2358-24



SCHROEDER
24,0 cm, 9½"
HS-2359-24



TEALE
23,0 cm, 9"
HS-2360-23



JACOBS
21,0 cm, 8½"
HS-2361-21



JACOBS
21,0 cm, 8½"
HS-2362-21



HAGGAI

S U R G I C A L

Hakenzangen
Uterine Tenaculum Forceps
Pinzas para coger el cuello del útero
Pinze per abbassare il collo del'utero



MUSEUX
24,0 cm, 9 1/2"



6 mm
HS-2363-06



8 mm
HS-2363-08



10 mm
HS-2363-10



MUSEUX
24,0 cm, 9 1/2"



6 mm
HS-2364-06



8 mm
HS-2364-08



10 mm
HS-2364-10

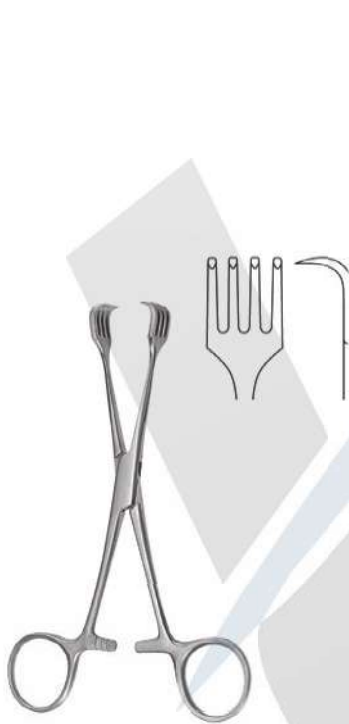

BRAUN
15,5 cm, 6"
HS-2365-15



CZERNY
20,5 cm, 8"
HS-2366-20



PRATT
28,0 cm, 11"
HS-2367-28

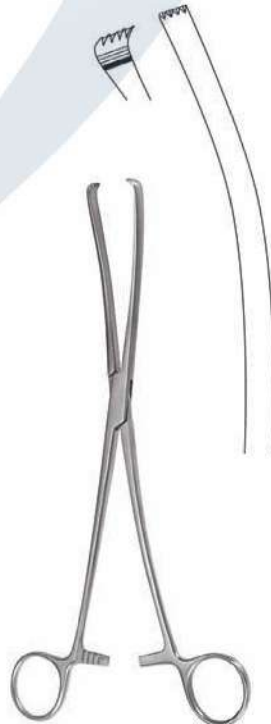

IOWA
26,0 cm, 10 1/4"
HS-2368-26



DOYEN
20,5 cm, 8"
HS-2369-20



NOTO
27,0 cm, 10⁵/₈"
HS-2370-27



KELLY
32,0 cm, 12¹/₂"
HS-2371-32



HEYWOOD-SMITH
25,0 cm, 9³/₄"
HS-2372-25



DARTIGUES
27,0 cm, 10³/₄"
HS-2373-27



SOMER
23,0 cm, 9"
HS-2374-23



COLLIN
25,0 cm, 9³/₄"
HS-2375-25



Amniotom
Amniotome
Amniótomo
Amniotomo

BEACHAM
26,0 cm, 10¹/₄"
HS-2376-26



Uterus-Depressor
Uterine depressor
Depresor uterino
Depressori uterini

BRAUN
28,0 cm, 11"
HS-2377-28



SIMS
32,0 cm, 12¹/₂"
HS-2378-32



biegsam
malleable
maleable
malleabile

SIMS
32,0 cm, 12¹/₂"
HS-2379-32



MARTIN
32,0 cm, 12¹/₂"
HS-2380-32



biegsam
malleable
maleable
malleabile

MARTIN
32,0 cm, 12¹/₂"
HS-2381-32



VALLEIX
25,0 cm, 10"
HS-2382-25



Ø 4 mm

biegsam
malleable
maleable
malleabile

SIMPSON
29,0 cm, 11¹/₂"
HS-2383-29



Ø 4 mm

COLLIN
28,0 cm, 11"
HS-2384-28



KEVORKIAN
30,0 cm, 12"
HS-2385-30



KEVORKIAN
30,0 cm, 12"
HS-2386-30



KEVORKIAN
30,0 cm, 12"
HS-2387-30



NOVAK
23,0 cm, 9"
HS-2391-04



RANDALL
23,0 cm, 9"
HS-2392-04



MILAN
29,0 cm, 11½"



Ø 4 mm
HS-2388-04



Ø 4 mm
HS-2389-04



Ø 4 mm
HS-2390-04



S U R G I C A L



UTERUSPERFORATOR
25,0 cm, 9³/₄"
HS-2393-25



FISTELHAKEN
25,0 cm, 9³/₄"
HS-2394-25



SIMON
22,0 cm, 8⁵/₈"
HS-2395-22



EMMETT
22,0 cm, 8⁵/₈"



HS-2396-01



HS-2396-02



HS-2396-03



HS-2396-04



HS-2396-05



SEGOND
27,0 cm, 10⁵/₈"
HS-2397-27



AYRE
23,0 cm, 9"
HS-2397-23

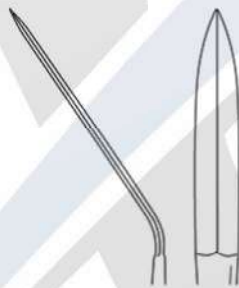

DOYEN
19,0 cm, 7¹/₂"
HS-2397-01



DOYEN
17,0 cm, 6³/₄"
HS-2397-02



scharf, fest
sharp, rigid
cortantes, rígidas
acute, rigide

Fig. 00	HS-2398-05
Fig. 0	HS-2398-06
Fig. 1	HS-2398-07
Fig. 2	HS-2398-08
Fig. 3	HS-2398-09
Fig. 4	HS-2398-11
Fig. 5	HS-2398-12
Fig. 6	HS-2398-14
Fig. 7	HS-2398-15
Fig. 8	HS-2398-16
Fig. 9	HS-2398-19
Fig. 10	HS-2398-20
Fig. 11	HS-2398-21
Fig. 12	HS-2398-23

RECAMIER
26,0 cm, 10 1/4"



scharf, biegsam
sharp, malleable
cortantes, maleable
acute, malleabile

Fig. 00	HS-2399-05
Fig. 0	HS-2399-06
Fig. 1	HS-2399-07
Fig. 2	HS-2399-08
Fig. 3	HS-2399-09
Fig. 4	HS-2399-11
Fig. 5	HS-2399-12
Fig. 6	HS-2399-14
Fig. 7	HS-2399-15
Fig. 8	HS-2399-16
Fig. 9	HS-2399-19
Fig. 10	HS-2399-20
Fig. 11	HS-2399-21
Fig. 12	HS-2399-23

RECAMIER
26,0 cm, 10 1/4"



5 mm
Fig. 00



6 mm
Fig. 0



7 mm
Fig. 1



8 mm
Fig. 2



9 mm
Fig. 3



11 mm
Fig. 4



12 mm
Fig. 5



14 mm
Fig. 6



15 mm
Fig. 7



16 mm
Fig. 8



19 mm
Fig. 9



20 mm
Fig. 10



21 mm
Fig. 11



23 mm
Fig. 12



scharf, fest
sharp, rigid
cortantes, rígidas
acute, rigide

Fig. 00	HS-2400-05
Fig. 0	HS-2400-06
Fig. 1	HS-2400-07
Fig. 2	HS-2400-08
Fig. 3	HS-2400-09
Fig. 4	HS-2400-11
Fig. 5	HS-2400-12
Fig. 6	HS-2400-14
Fig. 7	HS-2400-15
Fig. 8	HS-2400-16
Fig. 9	HS-2400-19
Fig. 10	HS-2400-20
Fig. 11	HS-2400-21
Fig. 12	HS-2400-23

SIMS

26,0 cm, 10 3/4"



scharf, biegsam
sharp, malleable
cortantes, maleable
acute, malleabile

Fig. 00	HS-2401-05
Fig. 0	HS-2401-06
Fig. 1	HS-2401-07
Fig. 2	HS-2401-08
Fig. 3	HS-2401-09
Fig. 4	HS-2401-11
Fig. 5	HS-2401-12
Fig. 6	HS-2401-14
Fig. 7	HS-2401-15
Fig. 8	HS-2401-16
Fig. 9	HS-2401-19
Fig. 10	HS-2401-20
Fig. 11	HS-2401-21
Fig. 12	HS-2401-23

SIMS

26,0 cm, 10 3/4"

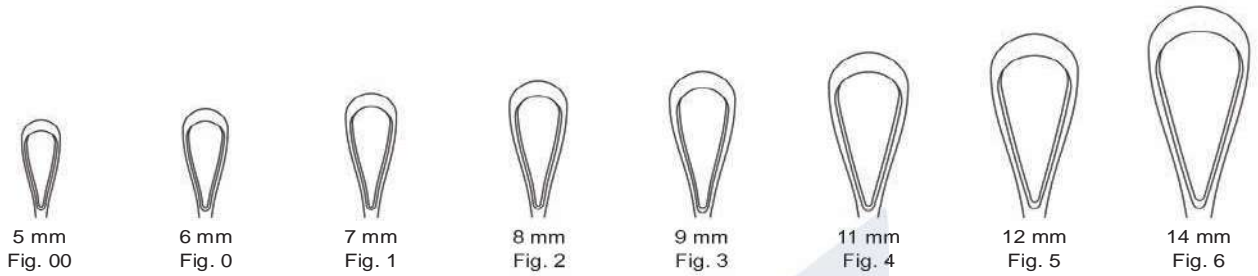

scharf, fest
sharp, rigid
cortantes, rígidas
acute, rigide

Fig. 00	HS-2402-05
Fig. 0	HS-2402-06
Fig. 1	HS-2402-07
Fig. 2	HS-2402-08
Fig. 3	HS-2402-09
Fig. 4	HS-2402-11
Fig. 5	HS-2402-12
Fig. 6	HS-2402-14
Fig. 7	HS-2402-15
Fig. 8	HS-2402-16
Fig. 9	HS-2402-19
Fig. 10	HS-2402-20
Fig. 11	HS-2402-21
Fig. 12	HS-2402-23

RECAMER
31,0 cm, 12 1/4"



scharf, biegsam
sharp, malleable
cortantes, maleable
acute, malleabile

Fig. 00	HS-2403-05
Fig. 0	HS-2403-06
Fig. 1	HS-2403-07
Fig. 2	HS-2403-08
Fig. 3	HS-2403-09
Fig. 4	HS-2403-11
Fig. 5	HS-2403-12
Fig. 6	HS-2403-14
Fig. 7	HS-2403-15
Fig. 8	HS-2403-16
Fig. 9	HS-2403-19
Fig. 10	HS-2403-20
Fig. 11	HS-2403-21
Fig. 12	HS-2403-23

RECAMER
31,0 cm, 12 1/4"



scharf, fest
sharp, rigid
cortantes, rígidas
acute, rigide

Fig. 00	HS-2404-05
Fig. 0	HS-2404-06
Fig. 1	HS-2404-07
Fig. 2	HS-2404-08
Fig. 3	HS-2404-09
Fig. 4	HS-2404-11
Fig. 5	HS-2404-12
Fig. 6	HS-2404-14
Fig. 7	HS-2404-15
Fig. 8	HS-2404-16
Fig. 9	HS-2404-19
Fig. 10	HS-2404-20
Fig. 11	HS-2404-21
Fig. 12	HS-2404-23

SIMS
31,0 cm, 12 1/4"



scharf, biegsam
sharp, malleable
cortantes, maleable
acute, malleabile

Fig. 00	HS-2405-05
Fig. 0	HS-2405-06
Fig. 1	HS-2405-07
Fig. 2	HS-2405-08
Fig. 3	HS-2405-09
Fig. 4	HS-2405-11
Fig. 5	HS-2405-12
Fig. 6	HS-2405-14
Fig. 7	HS-2405-15
Fig. 8	HS-2405-16
Fig. 9	HS-2405-19
Fig. 10	HS-2405-20
Fig. 11	HS-2405-21
Fig. 12	HS-2405-23

SIMS
31,0 cm, 12 1/4"

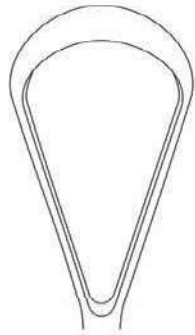

30 mm
Fig. 1

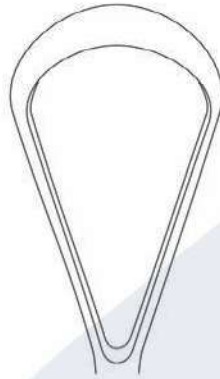

35 mm
Fig. 2

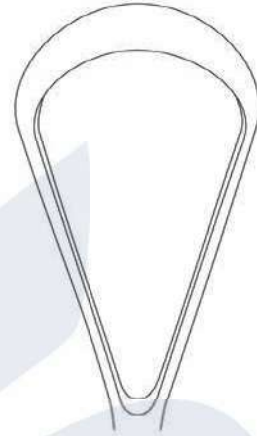

40 mm
Fig. 3



scharf, fest
sharp, rigid
cortantes, rígidas
acute, rigide

Fig. 1 HS-2406-30
Fig. 2 HS-2406-35
Fig. 3 HS-2406-40

SIMS
31,0 cm, 12¹/₄"



scharf, biegsam
sharp, malleable
cortantes, maleable
acute, malleabile

Fig. 1 HS-2407-30
Fig. 2 HS-2407-35
Fig. 3 HS-2407-40

SIMS
31,0 cm, 12¹/₄"

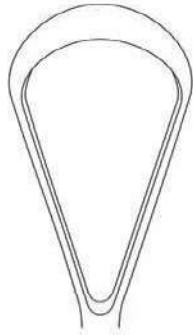

30 mm
Fig. 1

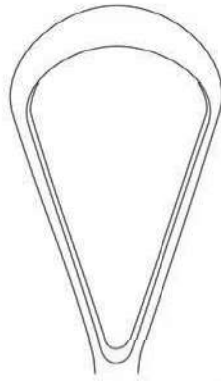

35 mm
Fig. 2

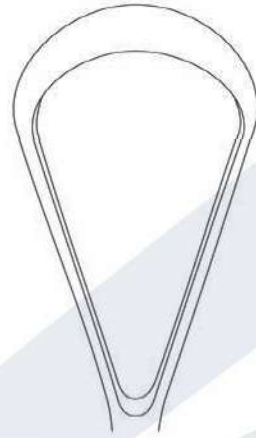

40 mm
Fig. 3



scharf, fest
sharp, rigid
cortantes, rígidas
acute, rigide

Fig. 1 **HS-2408-30**
Fig. 2 **HS-2408-35**
Fig. 3 **HS-2408-40**

BUMM
31,0 cm, 12¹/₄"



scharf, biegsam
sharp, malleable
cortantes, maleable
acute, malleabile

Fig. 1 **HS-2409-30**
Fig. 2 **HS-2409-35**
Fig. 3 **HS-2409-40**

BUMM
31,0 cm, 12¹/₄"



HAGGAI

S U R G I C A L

Uteruslöffel, Uterus-Biopsiezangen
Uterine Scoopes, Cervical Biopsy and Specimen Forceps
Cucharillas uterinas, Pinzas saca-bocados para biopsia
Curette uterine, Pinze per la biopsia cervicale e da prelievo



BLAKE
27,0 cm, 10⁵/₈"
HS-2411-27



SIMON
25,0 cm, 9³/₄"

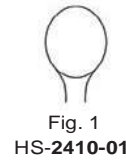

Fig. 1
HS-2410-01

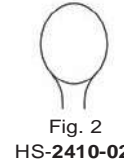

Fig. 2
HS-2410-02

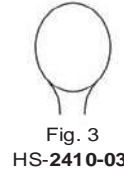

Fig. 3
HS-2410-03



Fig. 4
HS-2410-04

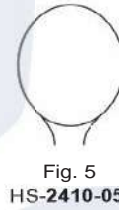

Fig. 5
HS-2410-05

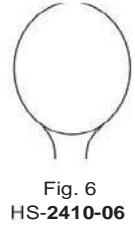

Fig. 6
HS-2410-06



THOMS-GAYLOR
22,0 cm, 8⁵/₈" HS-2412-22
24,0 cm, 9¹/₂" HS-2412-24



SCHUBERT
21,0 cm, 8¹/₄" HS-2413-21
29,0 cm, 11¹/₂" HS-2413-29

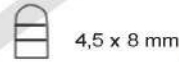

4,5 x 8 mm



SCHUMACHER-VAN DOREN
24,0 cm, 9¹/₂" HS-2414-24



5 mm



HAGGAI

S U R G I C A L

Uterus-Biopsiezangen
Cervical Biopsy and Specimen Forceps
Pinzas saca-bocados para biopsia
Pinze per la biopsia cervicale e da prelievo



THOMS-GAYLOR
24,0 cm, 9 1/2"
HS-2415-24



FAURE
21,0 cm, 8 1/4"
HS-2416-21



SCHUBERT
26,0 cm, 10 1/4"
HS-2417-26

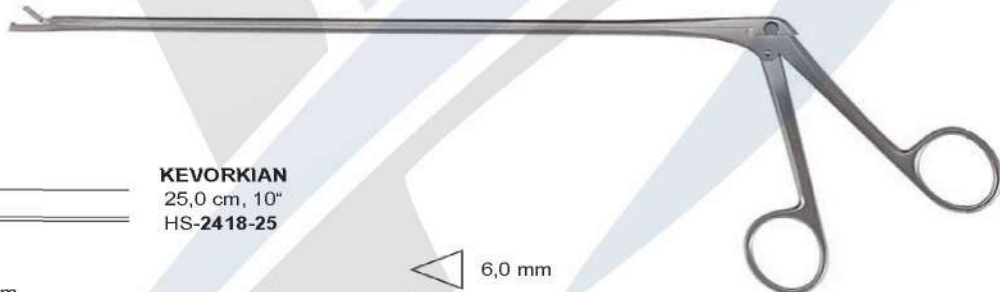

9 x 3 mm



KEVORKIAN
25,0 cm, 10"
HS-2418-25

4,5 x 8 mm



EPPENDORFER
20,0 cm, 8"
HS-2419-20

6,0 mm

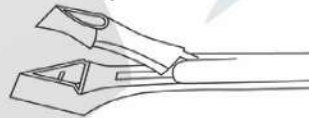

SCHUMACHER
24,0 cm, 9 1/2"
HS-2422-06

4,5 x 8 mm



ALEXANDER
28,0 cm, 11"
HS-2420-28



WITTNER
23,0 cm, 9"
HS-2423-23

4,0 mm

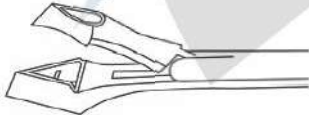

SCHUMACHER
24,0 cm, 9 1/2"
HS-2421-04

4,5 x 8 mm

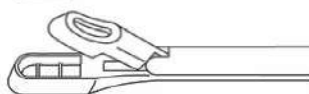

WITTNER
23,0 cm, 9"
HS-2424-23



HAGGAI

S U R G I C A L

Uterus-Biopsiezangen
Cervical Biopsy and Specimen Forceps
Pinzas saca-bocados para biopsia
Pinze per la biopsia cervicale e da prelievo

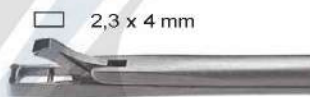

MINI-TOWNSEND
HS-2427-12

9 x 3 mm



TISCHLER-KEVORKIAN
HS-2429-41



BABY-TISCHLER
HS-2428-14

9 x 3 mm



KEVORKIAN-PACIFIC
HS-2430-40



WRIGLEY
28,0 cm, 11"
HS-2431-28



SIMPSON
30,0 cm, 11³/₄"
HS-2432-30



SIMPSON-BRAUN
33,0 cm, 13"
HS-2433-33



SIMPSON-BRAUN
36,0 cm, 14¹/₈"
HS-2434-36



SIMPSON-LUIKART
36,0 cm, 14¹/₈"
HS-2435-36



DE LEE
30,0 cm, 11³/₄"
HS-2436-30



DE LEE
36,0 cm, 14¹/₈"
HS-2437-36



DE LEE
38,0 cm, 15³/₈"
HS-2438-38



MC LEAN
36,0 cm, 14¹/₈"
HS-2439-36



KIELAND
41,0 cm, 16"
HS-2440-41



KIELAND-LUIKART
40,0 cm, 15³/₄"
HS-2441-40



PIPER
44,0 cm, 17¹/₄"
HS-2442-44



ELLIOT
32,0 cm, 12¹/₂"
HS-2443-32



ELLIOT
38,0 cm, 15"
HS-2444-38



NAEGELE
36,0 cm, 14³/₈"
HS-2445-36



NAEGELE
40,0 cm, 15³/₄"
HS-2446-40



GREEN-ARMYTAGE
21,0 cm, 8¹/₄"
HS-2447-21



PESTALOZZA
30,0 cm, 11³/₄"
HS-2448-30



SAENGER
27,0 cm, 10⁵/₈"
HS-2449-27



SAENGER
27,0 cm, 10⁵/₈"
HS-2450-27



WINTER
28,0 cm, 11"



Fig. 1
HS-2451-01



Fig. 2
HS-2451-02



Fig. 3
HS-2451-03



Fig. 1
HS-2452-01



Fig. 2
HS-2452-02



Fig. 3
HS-2452-03

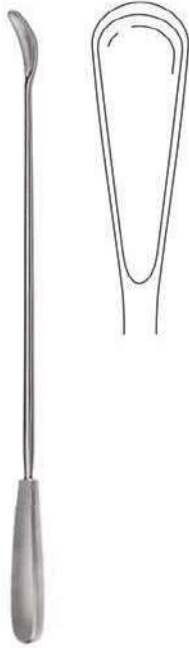

WALLICH
42,0 cm, 16 $\frac{1}{2}$ "
HS-2453-42



MARTIN
34,0 cm, 13 $\frac{3}{8}$ "
HS-2454-34



BIERER
33,0 cm, 13"
HS-2455-01



BIERER
33,0 cm, 13"
HS-2456-02



BIERER
33,0 cm, 13"
HS-2457-01



BIERER
33,0 cm, 13"
HS-2458-02

Vorbereitung, Dermatologie
Preparation, Dermatology
Preparación, Dermatología
Preparazione, Dermatologia





Lupusküretten
Lupus curettes
Curetas para lupus
Raschiatoio per lupus



3 mm
HS-2459-03



4 mm
HS-2459-04



5 mm
HS-2459-05

PIFFARD
14,0 cm, 5³/₄"



KEYES
12,0 cm, 4³/₄"



2 mm
HS-2460-02



3 mm
HS-2460-03



4 mm
HS-2460-04



5 mm
HS-2460-05



6 mm
HS-2460-06



7 mm
HS-2460-07



8 mm
HS-2460-08



KEYES
12,0 cm, 4³/₄"
HS-2461-00



NAGELBOHRER
HS-2462-00
komplett, complete,
completo, completo



HS-2462-01



HS-2462-02



HS-2462-03



UNNA
14,0 cm, 5 3/4"
HS-2463-14



UNNA
14,0 cm, 5 3/4"
HS-2464-14



SAALFELD
10,0 cm, 4"
HS-2465-10



SAALFELD
14,0 cm, 5 3/4"
HS-2466-14



SCHAMBERG
10,0 cm, 4"
HS-2467-10



WALTON
14,0 cm, 5 3/4"
HS-2468-14



FOX
14,0 cm, 5 3/4"

3 mm
HS-1100-03

4 mm
HS-11100-04

5 mm
HS-2469-05

6 mm
HS-2469-06

Lupusküretten
Lupus curettes
Curetas para lupus
Raschiatoio per lupus



059-1420-01

FINGERRINGSÄGE
17,0 cm, 6³/₄"
HS-2470-17



059-1430-01

WALTON
16,0 cm, 6¹/₄"
HS-2471-16



RADOLF
13,5 cm, 5³/₈"
HS-2472-13



NAGELZANGE
13,5 cm, 5³/₈"
HS-2473-13



NAGELZANGE
13,0 cm, 5"
HS-2474-13

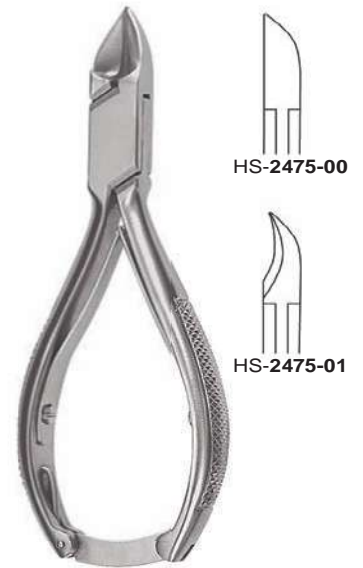

HS-2475-00

HS-2475-01

NAGELZANGE
14,0 cm, 5¹/₂"



HAGGAI

S U R G I C A L

Knochenchirurgie

Bone Surgery

Cirurgía ósea

Chirurgia ossea









		 Fig. 0000 HS-2477-04	 Fig. 0000 HS-2478-04
		 Fig. 000 HS-2477-03	 Fig. 000 HS-2478-03
 Fig. 000 HS-2476-03		 Fig. 00 HS-2477-02	 Fig. 00 HS-2478-02
 Fig. 00 HS-2476-02		 Fig. 0 HS-2477-01	 Fig. 0 HS-2478-01
 Fig. 00 HS-2476-02		 Fig. 1 HS-2477-11	 Fig. 1 HS-2478-11
 Fig. 0 HS-2476-01		 Fig. 2 HS-2477-12	 Fig. 2 HS-2478-12
 Fig. 1 HS-2476-11		 Fig. 3 HS-2477-13	 Fig. 3 HS-2478-13
 Fig. 2 HS-2476-12		 Fig. 4 HS-2477-14	 Fig. 4 HS-2478-14
 Fig. 3 HS-2476		 Fig. 5 HS-2477-15	 Fig. 5 HS-2478-15
 Fig. 4 HS-2476	 SCHEDÉ 17,0 cm, 6 ³ / ₄ "	 VOLKMAN 17,0 cm, 6 ³ / ₄ "	 BRUNS 17,0 cm, 6 ³ / ₄ "
		 Fig. 6 HS-2477-16	 Fig. 6 HS-2478-16

Fig. 00000
HS-2479-04

Fig. 0000
HS-2479-03

Fig. 000
HS-2479-02

Fig. 00
HS-2479-01

LEMPERT
21,5 cm, 8 1/2"

Fig. 0
HS-2479-00

HALLE
21,0 cm, 8 1/4"

Fig. 00
HS-2480-02

Fig. 0
HS-2480-01

Fig. 1
HS-2480-11

Fig. 00
HS-2481-02

Fig. 0
HS-2481-01

Fig. 1
HS-2481-11

Fig. 2
HS-2481-12

DAUBENSPECK
20,0 cm, 8"



WILLIGER
17,0 cm, 6³/₄"

Fig. 1
HS-2482-11

Fig. 2
HS-2482-12



WILLIGER
14,0 cm, 5¹/₂"

Fig. 0
HS-2483-00

Fig. 1
HS-2483-01

Fig. 2
HS-2483-02



MARTINI
14,0 cm, 5¹/₂"
HS-2485-00

Fig. 00/0
HS-2485-00
14,0 cm, 5¹/₂"

Fig. 0/1
HS-2485-01
14,0 cm, 5¹/₂"

Fig. 1/2
HS-2485-12
14,0 cm, 5¹/₂"



VOLKMANN

HS-2486-13
13,0 cm, 5"

HS-2486-14
14,0 cm, 5¹/₂"

HS-2486-17
17,0 cm, 6³/₄"



JANSEN
15,0 cm, 6"
HS-2487-15



JANSEN
16,0 cm, 6¹/₄"
HS-2487-16

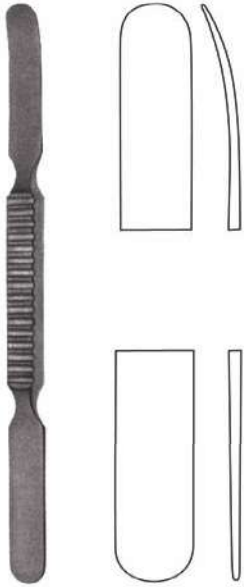

WATSON-CHEYNE
17,5 cm, 6⁵/₈"
HS-2488-17



MC DONALD
19,0 cm, 7¹/₂"
HS-2488-19



WILLIGER
17,0 cm, 6³/₄"
HS-2492-17



WILLIGER
16,0 cm, 6¹/₄"
HS-2489-16



LANGENBECK
20,0 cm, 8"
HS-2490-08



LANGENBECK
20,0 cm, 8"
HS-2491-10



ADSON
17,0 cm, 6³/₄"

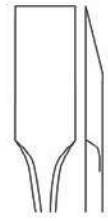

8 mm
HS-2493-01



7 mm
HS-2493-02



7 mm
HS-2493-03



7 mm
HS-2493-04



KÖNIG
15,5 cm, 6"
HS-2494-15

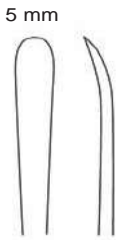

5 mm



LAMBOTTE
21,0 cm, 8¹/₄"



10 mm
HS-2494-10



15 mm
HS-2494-15



20 mm
HS-2494-20

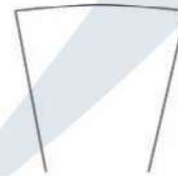

25 mm
HS-2494-25

12,5 mm



FARABEUF
15,0 cm, 6"
HS-2495-15





S U R G I C A L

12,5 mm

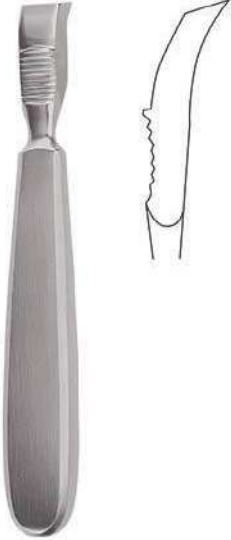

FARABEUF
15,0 cm, 6"
HS-2496-15

16,0 mm



LANGENBECK
19,0 cm, 7 1/2"
HS-2497-19

15,0 mm



SEDILLOT
21,0 cm, 8 1/4"
HS-2498-21



4 mm HS-2499-04
6 mm HS-2499-06
8 mm HS-2499-08

WILLIGER
16,0 cm, 6 1/4"



für Kinder
for children
para niños
per bambini

DOYEN
17,0 cm, 6 3/4"
HS-2500-17



für Kinder
for children
para niños
per bambini

DOYEN
17,0 cm, 6 3/4"
HS-2501-17



für Erwachsene
for adults
para adultos
per adulti

DOYEN
17,0 cm, 6 3/4"
HS-2502-17



für Erwachsene
for adults
para adultos
per adulti

DOYEN
17,0 cm, 6 3/4"
HS-2503-17



HAGGAI

S U R G I C A L

Flachmeißel, Hohlmeißel, Osteotome
Chisels, Gouges, Osteotomes
Cinceles, Gubias, Osteótomos
Scalpelli, Sgorbie, Osteotomi



8,0 mm	HS-2504-08
10,0 mm	HS-2504-10
12,0 mm	HS-2504-12
14,0 mm	HS-2504-14
16,0 mm	HS-2504-16

13,5 cm, 5³/₈"



8,0 mm	HS-2505-08
10,0 mm	HS-2505-10
12,0 mm	HS-2505-12
14,0 mm	HS-2505-14
16,0 mm	HS-2505-16

13,5 cm, 5³/₈"



8,0 mm	HS-2506-08
10,0 mm	HS-2506-10
12,0 mm	HS-2506-12
14,0 mm	HS-2506-14
16,0 mm	HS-2506-16

13,5 cm, 5³/₈"



3,0 mm	HS-2507-03
4,0 mm	HS-2507-04
5,0 mm	HS-2507-05
6,0 mm	HS-2507-06

PARTSCH
13,5 cm, 5³/₈"



3,0 mm	HS-2508-03
4,0 mm	HS-2508-04
5,0 mm	HS-2508-05
6,0 mm	HS-2508-06

PARTSCH
13,5 cm, 5³/₈"



10,0 mm	HS-2509-10
15,0 mm	HS-2509-15
20,0 mm	HS-2509-20
25,0 mm	HS-2509-25

STILLE
20,0 cm, 8"



10,0 mm	HS-2510-10
15,0 mm	HS-2510-15
20,0 mm	HS-2510-20
25,0 mm	HS-2510-25

STILLE
20,0 cm, 8"



10,0 mm	HS-2511-10
15,0 mm	HS-2511-15
20,0 mm	HS-2511-20
25,0 mm	HS-2511-25

STILLE
20,0 cm, 8"



4,0 mm	HS-2512-04
6,0 mm	HS-2512-06
8,0 mm	HS-2512-08
10,0 mm	HS-2512-10
12,0 mm	HS-2512-12
14,0 mm	HS-2512-14

ALEXANDER
18,0 cm, 7"



4,0 mm	HS-2513-04
6,0 mm	HS-2513-06
8,0 mm	HS-2513-08
10,0 mm	HS-2513-10
12,0 mm	HS-2513-12
14,0 mm	HS-2513-14

ALEXANDER
18,0 cm, 7"



6,0 mm	HS-2514-06
9,0 mm	HS-2514-09
13,0 mm	HS-2514-13
16,0 mm	HS-2514-16
19,0 mm	HS-2514-19
25,0 mm	HS-2514-25
32,0 mm	HS-2514-32

SMITH-PETERSEN
20,0 cm, 8"



6,0 mm	HS-2515-06
9,0 mm	HS-2515-09
13,0 mm	HS-2515-13
16,0 mm	HS-2515-16
19,0 mm	HS-2515-19
25,0 mm	HS-2515-25
32,0 mm	HS-2515-32

SMITH-PETERSEN
20,0 cm, 8"



9,0 mm	HS-2516-09
14,0 mm	HS-2516-14
16,0 mm	HS-2516-16
19,0 mm	HS-2516-19
25,0 mm	HS-2516-25

SMITH-PETERSEN
20,0 cm, 8"



9,0 mm	HS-2517-09
14,0 mm	HS-2517-14
16,0 mm	HS-2517-16
19,0 mm	HS-2517-19
25,0 mm	HS-2517-25

SMITH-PETERSEN
20,0 cm, 8"



6,0 mm	HS-2518-06
15,0 mm	HS-2518-15
20,0 mm	HS-2518-20
25,0 mm	HS-2518-25
30,0 mm	HS-2518-30
38,0 mm	HS-2518-38
44,0 mm	HS-2518-44
50,0 mm	HS-2518-50

LAMBOTTE
24,0 cm, 9 1/2"



6,0 mm	HS-2519-06
15,0 mm	HS-2519-15
20,0 mm	HS-2519-20
25,0 mm	HS-2519-25
30,0 mm	HS-2519-30
38,0 mm	HS-2519-38
44,0 mm	HS-2519-44
50,0 mm	HS-2519-50

LAMBOTTE
24,0 cm, 9 1/2"

Ø 30 mm
220 g



COLLIN
20,0 cm, 8"
HS-2520-20

Ø 22 mm
200 g



mit Bleifüllung
lead filled head
cabezal relleno de plomo
testa di piombo

PARTSCH
18,0 cm, 7"
HS-2521-18

Ø 45 mm
300 g



BERGMANN
24,0 cm, 9 1/2"
HS-2522-24

Sterilisation
Sterilization
Esterilización
Sterilizzazione





20,0 cm, 8"
HS-2522-20



CHEATTLE
27,0 cm, 10⁵/₈"
HS-2523-27



ROGGE
23,0 cm, 9"
HS-2524-23



PYE-SMITH (HARRISON)
30,0 cm, 12"
HS-2525-30



MAYO
14,0 cm, 5¹/₂"
HS-2526-14



BUNT
12,0 cm, 4³/₄"
HS-2527-12



STANDZYLINDER

Ø 75 x 130 mm	HW-2528-06
Ø 75 x 175 mm	HW-2528-07
Ø 100 x 175 mm	HW-2528-08
Ø 100 x 200 mm	HW-2528-09



RUNDE SCHALE

Ø 40,0 mm	HW-1130-04
Ø 60,0 mm	HW-1130-06
Ø 80,0 mm	HW-1130-08
Ø 100,0 mm	HW-1130-10
Ø 120,0 mm	HW-1130-12
Ø 150,0 mm	HW-1130-15



SPÜLSCHALE

165 x 55 mm	0,75 l	HWI-1133-00
175 x 70 mm	1,00 l	HWI-1133-10
225 x 100 mm	2,00 l	HWI-1133-20
240 x 95 mm	2,75 l	HWI-1133-30
260 x 120 mm	4,00 l	HWI-1133-40
290 x 100 mm	5,00 l	HWI-1133-50
315 x 150 mm	5,50 l	HWI-1133-60
325 x 135 mm	8,00 l	HWI-1133-70
360 x 165 mm	12,00 l	HWI-1133-80
415 x 150 mm	14,00 l	HWI-1133-90



NIERENSCHALE

170 mm	HW-1140-17
250 mm	HW-1140-25
275 mm	HW-1140-27



INSTRUMENTENKÄSTCHEN

200 x 150 x 25 mm	HW-1200-01
260 x 180 x 30 mm	HW-1200-02
300 x 220 x 30 mm	HW-1200-03
350 x 220 x 40 mm	HW-1200-04
220 x 170 x 50 mm	HW-1200-05
280 x 200 x 50 mm	HW-1200-06
320 x 240 x 50 mm	HW-1200-07
370 x 270 x 50 mm	HW-1200-08
420 x 320 x 50 mm	HW-1200-09



NAEDELDOSE

HW-1300-00

Ø 65 x 17 mm

Außen- und Innendose

Exterior and interior box

Caja exterior e interior

Scatola esterna es interiore

HW-1300-01

Ø 62 x 13 mm

Innendose allein

Interior box only

Caja interior, suelta

Scatola interiore sola



**SPÜLSCHALE
MIT SKALIERUNG**

25 ccm

HW-310-25



**SPÜLBECHER
MIT SKALIERUNG**

50 ccm

HW-310-50

GET IN TOUCH

**Address: P.O. Sadder Cantt Dhallay
Sialkot - 51310 Punjab Pakistan**

Cell: +92 324 6042419

Tel: +92 052 4354217

Email: info@haggaisurgical.com

Web: www.haggaisurgical.com