



VETERINARY CATALOGUE
INSTRUMENTS



TABLE OF CONTENT

01	Balling Guns	01
02	Bone Surgery	02-03
03	Castration instrumentts	04-05
04	Ear Marking & Taging	06
05	Dehorner Instruments	07
06	Equine Dental Instruments	07-08
07	Farrier Tools	09-11
08	Grooming Equipment & Hoof Rasps	12
09	Hoof & Claw Instruments	13-17
10	Injectors & Extractors	18
11	Obstetrical Instruments	19
12	Plaster Instruments & Snake Catchers	20
13	Restraining Instruments	21-22
14	Ring Applicators & Teat Instruments	23
15	Vaginal Speculums	24
16	Snaffles. Dee. Ring Snaffle Bits	25-26
17	Spurs and Stirrups	27
18	Halters & Reins	28
19	Horse Measuring Sticks & Chariot Chains	29
20	Girths	30
21	Polo Wraps - Track Bandages	31
22	Seat Stick & Shipping Boots	32
23	Saddles	33
24	Horse Riding Gloves	34-35
25	Splint Boots and Whips Crops & Bats	36
26	Surgical Forceps & Towel Clamps	37
27	Dressing and Tissue Forceps, Hollowares, Scalpel Handles	38
28	Needle Holders & Scissors	39
29	Retractors	40
30	Equine Surgical & Miscellaneous Instruments	41
31	Root Elevators	42-43
32	Scalers, Probes, Dental Extraction Forceps and Mouth Retractors for Cats & Dogs	44





HAGGAI

SURGICAL

Balling Guns

01-1001 Mini Balling Gun

Balling gun with spring clips 1.25" Metal head, brass : Length 14.75"



01-1002 Metal Head Balling Gun

Balling gun with 3" Metal head, brass: Length 17".



01-1003 Plastic Head Balling Gun

Balling gun with 2.5" Plastic head, brass: Length 17".



01-1004 Balling Gun

Balling gun with 5" Metal head, brass: Length 22".



01-1005 Rubber Head Balling Gun

Balling gun with spring clips 4" Rubber head, brass: Length 23.5".



01-1006 Pistol Balling Gun / Multi Bolus Balling Gun

Nickel-plated metal balling gun which holds up to six large boluses at one time. Uses a spring-action end-clip to secure boluses in barrel: Length 18.25".

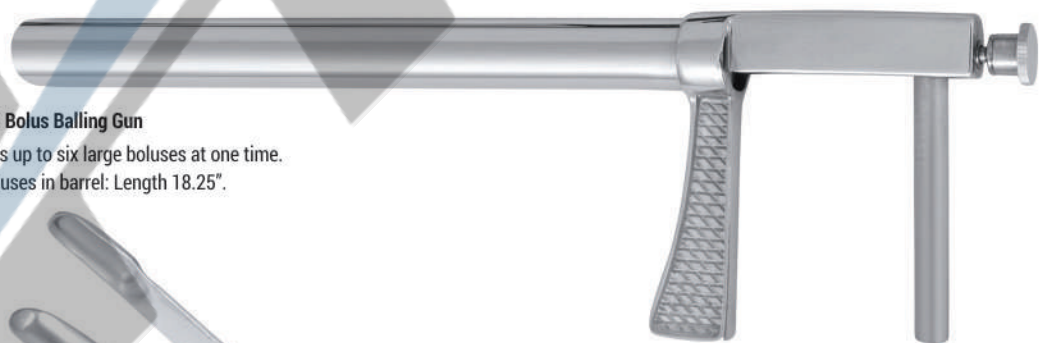

01-1007 British Capsule Forceps

Excellent for capsuling sheep or horses. Stainless steel: Length 12".





Bone Surgery

HAGGAI

SURGICAL

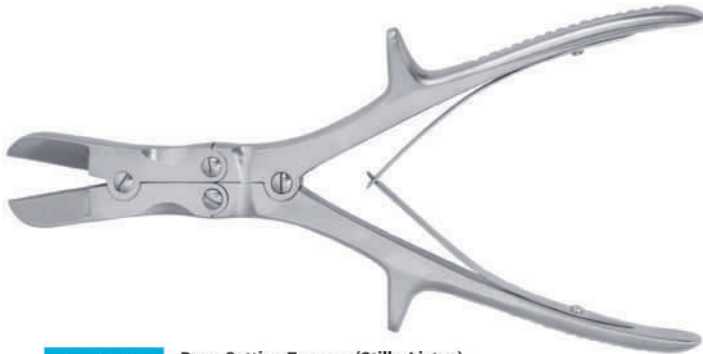

01-1008 Bone Cutting Forceps (Stille-Liston)

Also available in curved blade. Length 10.5" .

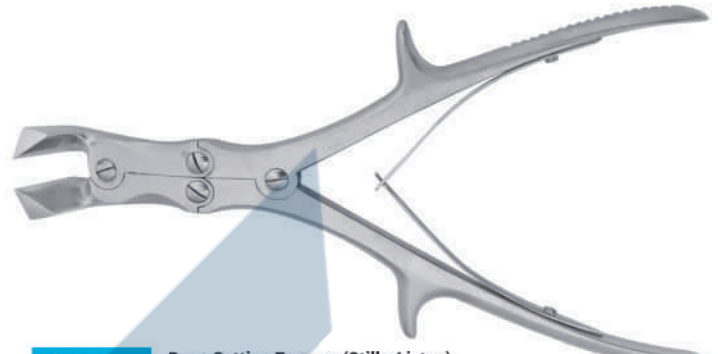

01-1009 Bone Cutting Forceps (Stille-Liston)

Angled blades. Length 10.5"

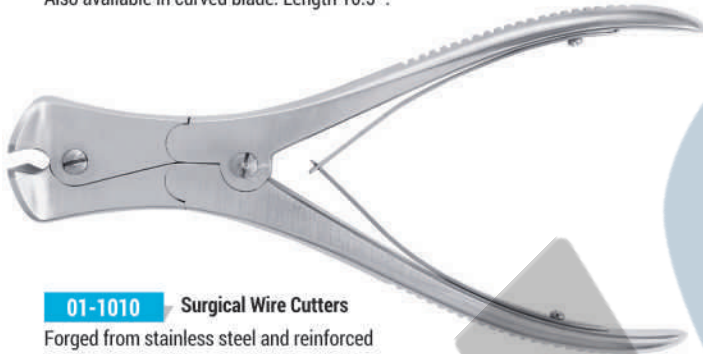

01-1010 Surgical Wire Cutters

Forged from stainless steel and reinforced with tungsten carbide tip or specially

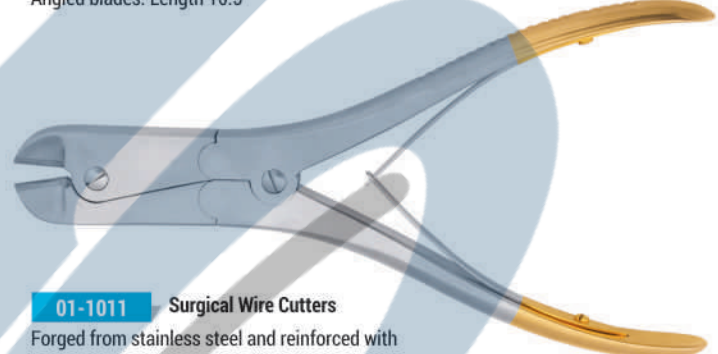

01-1011 Surgical Wire Cutters

Forged from stainless steel and reinforced with tungsten carbide tip or specially tempered tool steel. Size 9.25"

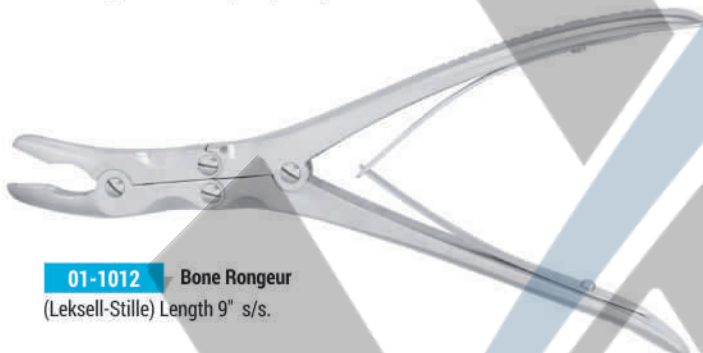

01-1012 Bone Rongeur

(Leksell-Stille) Length 9" s/s.



01-1013 Surgical Pin Cutters

Cutting tools used to cut the wires and pins implanted during the orthopedic surgeries to fix the fractures. They are forged from stainless steel and reinforced with tungsten carbide or specially tempered tool steel. The handles are so firm that they are able to provide more power for cutting and absorb the jerk of wire cutting. Length 18.5" .

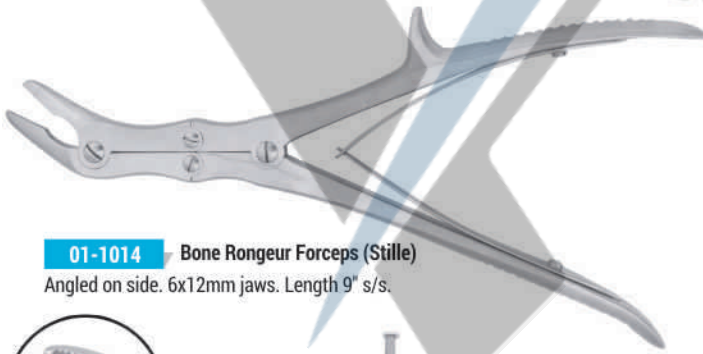

01-1014 Bone Rongeur Forceps (Stille)

Angled on side. 6x12mm jaws. Length 9" s/s.

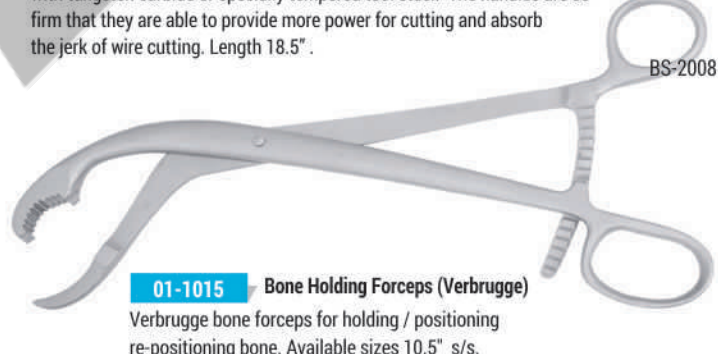

01-1015 Bone Holding Forceps (Verbrugge)

Verbrugge bone forceps for holding / positioning re-positioning bone. Available sizes 10.5" s/s.



01-1016 Bone Holding Forceps

Length 11" s/s



01-1017 Bone Holding Forceps (Lambotte)

Lambotte bone holding forceps with ratchet. Available Sizes 8.5", 10", 13" s/s.

BS-2008



HAGGAI

SURGICAL

Bone Surgery



01-1018 Bone Holding Forceps
Length 13.5" s/s.



01-1019 Bone Holding Clamp Lowman
Lowman bone clamp for holding, positioning, re-positioning bone. 1 x 2 Prong Jaws. Length 8" s/s.

Branding Instruments



01-1020 Revolving Head Tattoo Pliers
Made of special aluminum alloy. Head holds four dies on each side, for a total of eight digits. Size 3/8" revolving head tattoo outfit.



01-1021 Standard Tattoo Pliers
Designed in the same general style as our regular cattle tattoos but reduced in size to make work more convenient with small animals. Head holds four dies, for a total of four digits. Size 3/8".

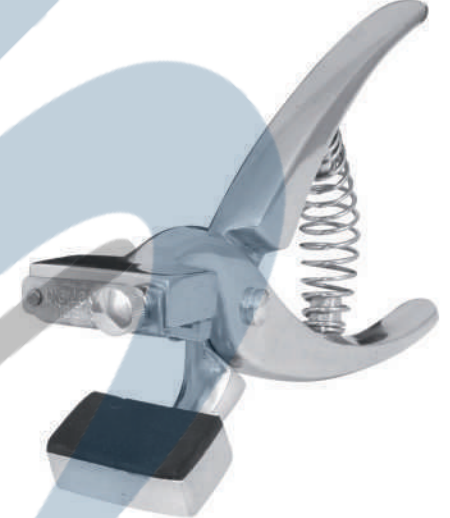

01-1022 Small Tattoo Pliers
Light weight pattern, designed for small animals. Made of aluminum alloy. Head holds four dies, for a total of four digits. Size 0.25".



01-1023 Tattoo Letter Set 0-9
Tattoo digits for Revolving head tattoo pliers and Standard tattoo pliers. Size 3/8". Tattoo digits for Small tattoo pliers. Size 0.25".



01-1024 Aluminum Paint Branding Irons
Made of aluminum castings, light in weight. Set consists of nine irons in 2.5" sizes. 0.5" depth, 1.5" width. Also available in 4" sizes. NOTE: A set 0-9 does not include the figure 9. The 6 iron can be reversed to make the figure 9.



01-1025 Aluminum Tattoo Pliers
The Aluminum Tattoo Pliers has a heavy duty spring for quicker release.



01-1026 Tattoo Pliers
Made of carbon steel.



01-1027 Tattoo Pliers
Two rows of tattoo digits can be inserted at a time. Made of carbon steel.



HAGGAI

SURGICAL

Castration Instruments



01-1028 Emasculatome 9" Castrator- Extra Small Size

These are precision-made instruments for the humane and bloodless castration of live stock by severing the testicular cord without injury to the bag (scrotum). Also Available with plastic and wooden grips. For lambs. Length 9".



01-1029 Emasculatome 12" Castrator- Small Size

Also available with plastic grips. For lambs and young calves or for docking lambs tail. Length 12".



01-1030 Emasculatome 14" Castrator- Medium Size

Also available with plastic grips. For calves and young bulls. Length 14".

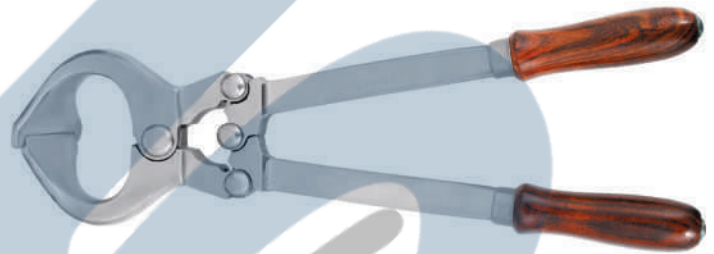

01-1031 Emasculatome 16" Castrator- Large Size

Also available with plastic grips. For mature bulls. Length 16"



01-1032 Emasculatome 19" Castrator- X Large Size

Also available with plastic grips. For bulls, horses, buffalo, and camels. Length 19".

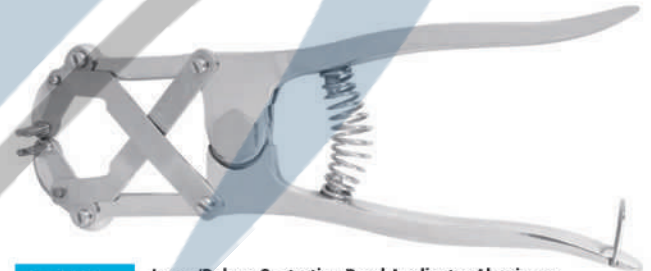

01-1033 Large/Deluxe Castrating Band Applicator Aluminum

Heavy-duty aluminum ring applicator with notched expanding fingers to hold the ring. Useful on lambs, calves, goats and other animals



01-1034 Castrating Band Applicator - Stainless Steel

For applying latex rings/bands used in tail docking and castration. The tapered nose prevents dirt build-up. Roller insures smooth operation: Length 8.75".



01-1035 Castrating Band Applicator - Nickel Plated

For applying latex rings/bands used in tail docking and castration. The tapered nose prevents dirt build-up. Roller insures smooth operation: Length 8.75".

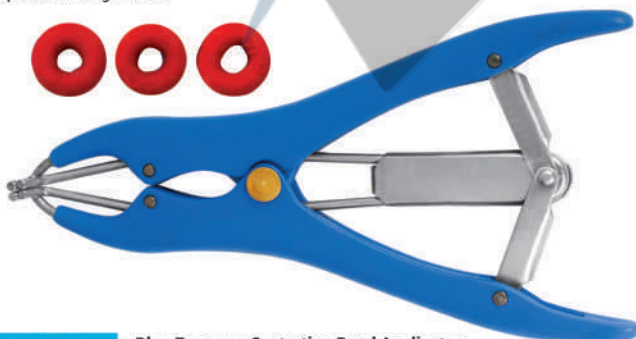

01-1036 Blue Economy Castrating Band Applicator

Designed for quick and easy one-person operation. Lightweight blue plastic grips, textured for sure-grip, comfortable to use. Useful on lambs, calves, goats and other animals.



01-1037 Crutch Knee Wrench - For Large Emasculatomes

The use of the crutch knee attachment makes possible a one-person operation with the larger emasculatome. Set consists of polished crutch attachment and spanner wrench. Fits 14", 16" and 19" emasculatomes only.



HAGGAI

SURGICAL

Castration Instruments



01-1038 Ear Docking

For dog's ear docking. Aluminum made. Straight, 12cm. Also available in curved.



01-1039 Frank's Emasculator

Length 7-1/2", 9", 10-1/2" s/s.



01-1040 Haussman's Emasculator

Double crush prevents primary and secondary hemorrhage because of the multiple crushing of the spermatic cord and artery. Sizes available 7-1/2", 9", 10", 11", 12" s/s



01-1041 White's Emasculator

Length 7-1/2", 9", 10", 11", 12" s/s.



01-1042 Haussman's Emasculator / Real Product

Curved, sizes available from 7-1/2", 9", 10", 11", 12" s/s.



01-1043 Reimer's Emasculator

A very popular emasculator has a double crushing part. The cutting lever is worked separately. This allows extra time for crushing action and eliminates after bleeding: Length 12" s/s.



01-1044 Serra's Emasculator Curved

A concave cutting plate draws the cord concentrically in to the jaws of the castrator. Reduces tissue slippage and post-op hemorrhage. Length 14" s/s



01-1045 Serra's Emasculator Curved With Ratchet

It has curved non slip grips and positive crush for one hand use with ratchet: Length 14" s/s.



01-1046 Serra's Emasculator With Ratchet

This newly designed instrument draws the cord concentrically into the jaws, thus preventing slipping of the cord. ratchet holds emasculator locked: Length 13-1/2" s/s.



01-1047 Sand's Emasculator

Draws the cord concentrically in to the jaws, thus preventing slipping of the cord. Hemorrhage is reduced to a minimum ratchet holds forceps locked: Length 12" s/s



01-1049 Gas Tail Docker

For quick, painless and economical tail docking of piglets. Stainless steel.



01-1048 Castration Hook for Male cats



01-1050 Newberry Castrating Knife

A stainless steel castrating knife will split the scrotum for easier removal of testicles with 2" blades. Overall Length 10.5".



Ear Marking & Taging

HAGGAI

SURGICAL



01-1051 Flower-Cut Ear Notcher
The stainless steel construction with sharp, clean cut and slide spring action handle make these notchers ideal for identification purposes. Cuts notch 1" long. Length 8".



01-1052 W-Cut Ear Notcher
A high-quality, stainless steel ear notcher Cuts a "W" notch 0.70" long. Length 6".

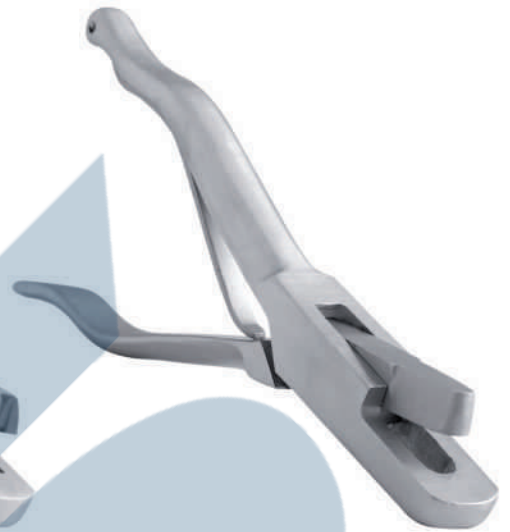

01-1053 U-Cut Ear Notcher
A high-quality, stainless steel ear notcher Cuts a "U" notch 0.70" long. Length 6".

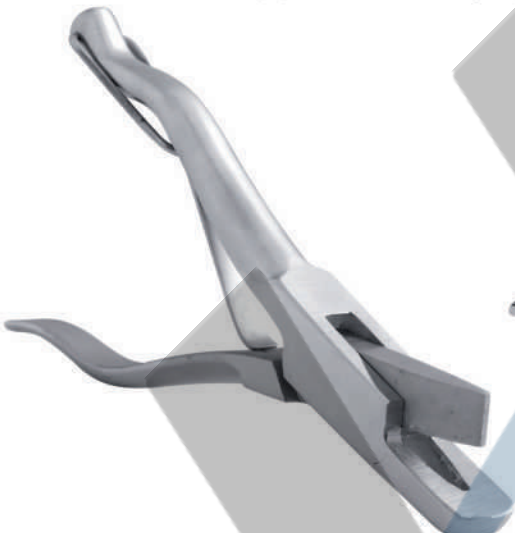

01-1054 Small Ear Notcher With V-Cut
A high-quality, stainless steel ear notcher Cuts a "V" notch 8mm/0.32" base x 16mm/0.63" long. Length 6".



01-1055 Medium Ear Notcher With V Shape Die
A high-quality, stainless steel ear notcher Cuts a "V" notch 12mm/0.47" base x 18mm/0.71" long. Length 6".



01-1056 Large Ear Notcher With V Shape Die
carefully ground after being hardened and tempered. Dies are not interchangeable. 20.85mm/0.82" cut. Length 9.37".

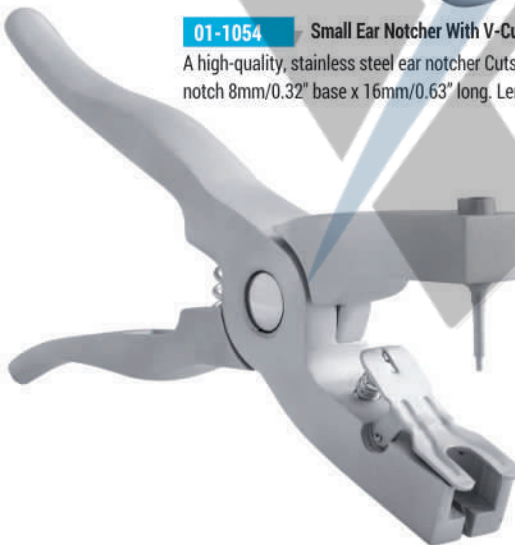

01-1057 Ear Tag Applicator



01-1058 Plastic Tag Applicator
For applying plastic tags to the ears. Length 9".



HAGGAI

SURGICAL

Dehorers Instruments



01-1059 Dehorner Wooden Handle
Wooden handle dehorner: Length 13" c/s.



01-1060 Dehorner Metal Handle
Straight metal handle dehorner with rubber grips: Length 13" c/s, c/p.



01-1061 Dehorner Metal Handle
Straight metal handle dehorner with rubber grips: Length 17" c/s, c/p.

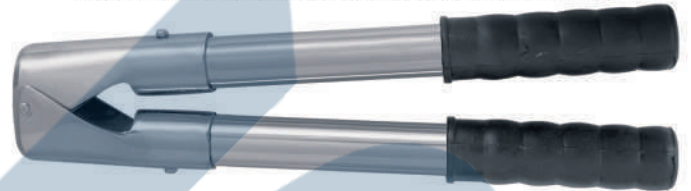

01-1062 Dehorner Metal Handle
Straight metal handle dehorner with rubber grips. Heat-treated steel cutting blades: Length 13" c/s, c/p.

Equine Dental Instruments



01-1063 Tooth Cutter
Hardened stainless steel simple joint lower molar cutters with permanent handles. Length 22" s/s.



01-1064 Tooth Cutter
Molar cutter with simple joint. Available in 3 different models. 1) Closed Edges. / 2) Medium Gap. / 3) Wide Gap. Length 22" s/s.



01-1065 Molar Forceps
Length 18", 22" s/s.



01-1066 Equine Molar Forceps-
Gunther Tooth Forceps. Length 22" s/s.



01-1067 Molar Forceps
Serrated jaw creates good purchase on cheek teeth and premolar caps. A hugely versatile pair of forceps for every day use. Length 22" s/s.



01-1068 Molar Spreader
Used for loosening cheek teeth prior to extraction: Length 19", 22" s/s.



01-1069 Molar Incisor Extractor
These are designed to remove hard to get at rear molars but can also be used to remove incisors. Length 22" s/s.



01-1070 Equine Compound Molar Cutter
Stainless steel compound molar cutters with permanent handles. Powerful compound action. Available in 4 different models. 1) Fully Open Jaw. / 2) Closed Jaw. 3) Part Open Jaw. / 4) Part Open Jaw Angled. Length 24", 25", 26" s/s.



Equine Dental Instruments

HAGGAI

SURGICAL

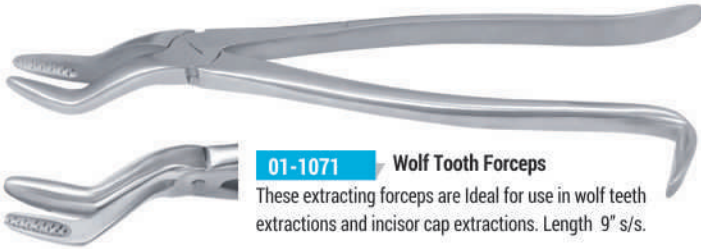

01-1071 Wolf Tooth Forceps
These extracting forceps are ideal for use in wolf teeth extractions and incisor cap extractions. Length 9" s/s.



01-1072 Wolf Tooth Forceps / Extracting Forceps
Knurled handles provide optimum grip even when wet. Length 10" s/s.

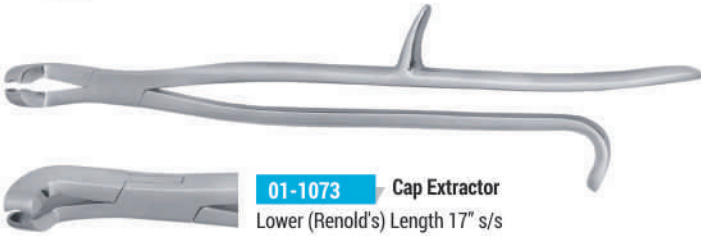

01-1073 Cap Extractor
Lower (Renold's) Length 17" s/s



01-1074 Cap Extractor
Upper (Renold's) Length 17" s/s.



01-1075 Compound Rongeurs
Stainless steel compound rongeur with offset head works well for wolf teeth, blind wolf teeth, incisor fragments and most tooth and cap slivers. Length 9" s/s.



01-1076 Fulcrum Serrated Jaw Box Joint Forceps
For extraction of first and second premolars or the number six and seven cheek teeth. This unit uses the hinge portion of the forceps for a fulcrum.



01-1077 3 Root Box Joint Forceps On Side
With knurled handles. For molars with very little crown in aged horses and deciduous premolar caps: Length 19" s/s



01-1078 3 Root Box Joint Forceps Off Side
With knurled handles. For molars with very little crown in aged horses and deciduous premolar caps. Length 19" s/s.

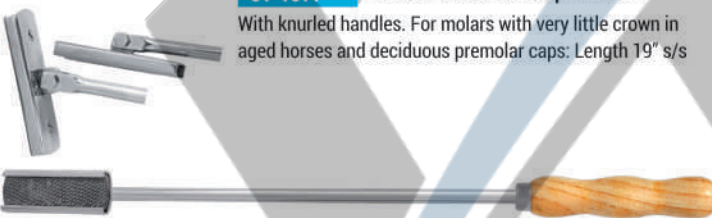

01-1079 Dental Float Moveable
Float comes with the moveable head with one wooden handle. With two screws in back to hold blade. Length 22".



01-1081 Dental Float
Combination float comes with both a straight and angled head. Length 10", with one wooden handle. Length 10.5". With two screws in back to hold blade. One rasp/rasp and one rasp/file in set. Length 20.5"



01-1080 Pig Tooth Nipper
Hardened stainless steel nippers with no gap in the jaws, construction with spring handle action. Also for cutting tails. Length 5" s/s.



01-1082 Equine Speculum By Schoupe
Reduces the danger of slipping with this instrument since it is held in place by the equine cheek area. I



01-1083 Bayer's Mouth Wedge
Very handy when examining the oral cavity or doing dental work in equine, s/s.



Farrier Tools

HAGGAI

SURGICAL



01-1084 Hoof Nipper T.C Tip Modified

A modified instrument which is forged from stainless steel and reinforced with tungsten carbide tip. Length 15". Also available in high carbon steel.

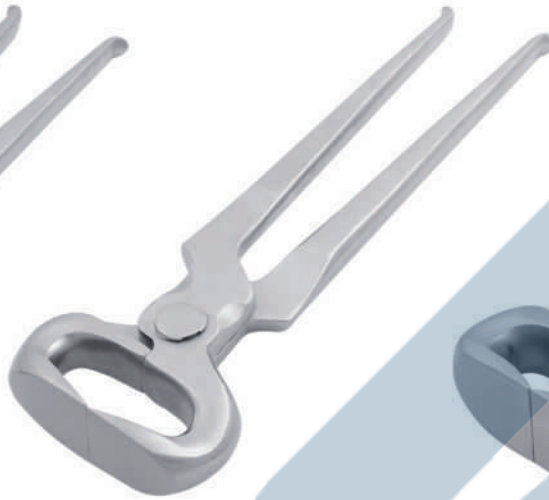

01-1085 Hoof Nipper

Particularly handy for farriers trimming larger feet or cob type horses with thicker walls. Forged from stainless steel. Length 15". Also available in high carbon steel.

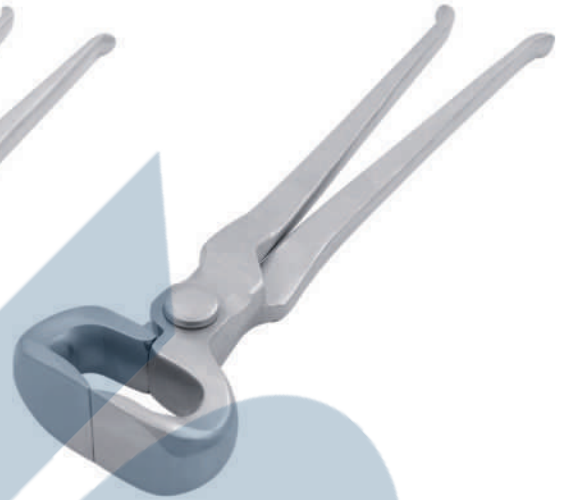

01-1086 Hoof Nipper

Ideal for trimming away excess hoof wall or claws. Forged from stainless steel. Length 14". Also available in high carbon steel.



01-1087 Hoof Nipper

A very nice precision instrument, forged from stainless steel. Length 12".



01-1088 Hoof Nipper

Length 14". Also available in 12", 15" c/s.



01-1089 Hoof Nipper

Length 12". Also available in 14", 15" c/s.



01-1090 Hoof Nipper Curved Blade T.C Tip Modified

A modified instrument which is forged from stainless steel and reinforced with tungsten carbide tip. Length 15". Also available in 12", 14" c/s.



01-1091 Hoof Nipper Curved Blade

A modified instrument which is forged from stainless steel and has a curved blade. Length 15". Also available in 12", 14" c/s.



Farrier Tools

HAGGAI

SURGICAL



01-1092 Heavy Duty Hoof Nipper
Fine quality steel hoof nipper with cushion grip handles. Length 15". Also available in 12", 14" c/s.



01-1093 Hoof Nipper
Designed exclusively to trim away excess hoof wall. Length 15". Also available in 12", 14" c/s.



01-1094 Hoof Nipper
Hoof nipper is used to trim away excess hoof wall. Vinyl handles give a comfortable feel in the hand. Length 15" c/s.



01-1095 Hoof Nipper
Hoof Nipper Length 12" c/s.

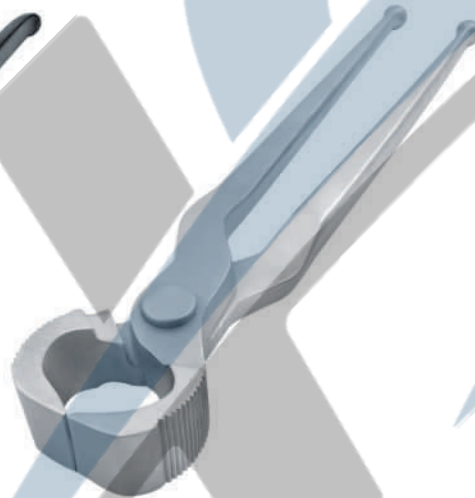

01-1096 Shoe Puller And Spreader With T.C Tip Modified
A combination shoe puller and spreader. Heat treated for strength. It is a modified instrument with a Tungsten Carbide tip. Length 13".



01-1097 Shoe Puller And Spreader
A combination shoe puller and spreader. Has exclusive pattern with sharp teeth on outside edges. Length 13" c/s.



01-1098 Shoe Puller And Spreader
Has exclusive pattern with sharp teeth on outside edges. For ease in spreading most shoe sizes and styles. Length 13" c/s.



01-1099 Shoe Pullers (Pull-Offs)
As sharp as a nipper so you can easily use it as a nail cutter. Length 15".



HAGGAI

SURGICAL

Farrier Tools



01-1100 Gooseneck Clincher
Length 12" c/s. Also available in stainless steel.



01-1102 Farrier Clincher
For use on high and low nails. Used to roll over nails with curved jaw. Length 13" c/s. Also available in stainless steel.



01-1104 Farrier Clincher
For use with larger nails used in saddle horse hoofs to roll over and clinch nails. Oil quoting makes it rust resistant. Length 12" c/s. Also available in stainless steel.



01-1106 Farrier Clincher
For use with large nails used in saddles horse hoofs to roll over and clinch nails. Oil quoting makes it rust resistant. Length 12" c/s. Also available in stainless steel.



01-1108 Cutting Nipper
For cutting and pulling with cushion grip handles. Length 12" c/s. Also available in stainless steel.



01-1110 Crease Nail Puller powder
Coated Removes nails from crease of shoes that has been on horse for some time, 12" carbon steel powder coated. Also available in stainless steel.



01-1112 Clinch Cutter
Clinch cutter on one end and pritchel on opposite end s/s.



01-1101 Low Nail Curved Jaw Clincher
The curved jaw clincher features a proven design for excellent performance and reliability. Length 13" c/s. Also available in stainless steel.

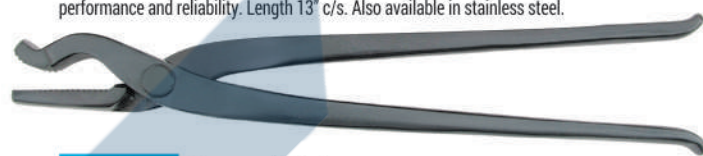

01-1103 Gooseneck Clincher
Powder coating makes it rust resistant. Length 12" c/s. Also available in stainless steel.



01-1105 Farrier Clincher
To roll over nails with curved jaw. Red vinyl coated handle gives a comfortable grip. Length 13" c/s. Also available in stainless steel.



01-1107 Cutting Nipper
For cutting and pulling with cushion grip handles. Oil tempered and drop forged. Length 12" c/s. Also available in stainless steel.



01-1109 Crease Nail Puller
For the removal of nails when worn down inside the grooves of the shoe, 12" s/s



01-1111 Shoe Spreader
The design of this tool is simply a levering device with a differential length of arms on the head. The shoe there by opening it exactly where you want.



01-1113 Clinch Cutter Powder Coated
Clinch cutter on one end and pritchel on opposite end, Powder coated c/s.

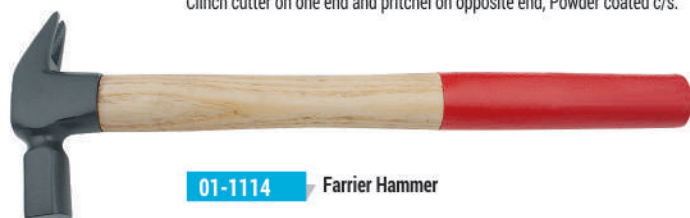

01-1114 Farrier Hammer



HAGGAI

Grooming Equipments

SURGICAL



01-1115 Horse Machine
Removes unwanted whiskers and hairs. American pattern, Sand caste, Chromed.

01-1116 Horse Machine
Removes unwanted hair and whiskers from Horse & Cattle, Putor, German pattern. Red wooden handle.

01-1117 Machine For Sheep
Removes unwanted hair from Sheep Putor, German pattern, Red wooden handle.



01-1118 Hand Clipper
Spring type sheep shear (For Horse, Camel and Donkey)



01-1120 Bot Egg Knife Plastic
The safe efficient way to remove bot eggs. It has no sharp edges to gouge the horse and can be used by the youngest rider with safety. This bot egg knife is 8.75" long with a stainless steel blade.

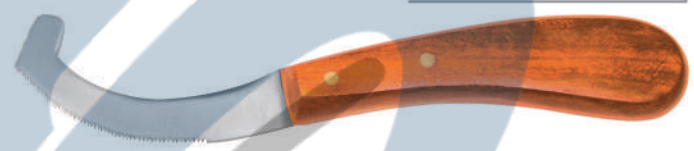

01-1121 Bot Egg Knife Wooden
This bot egg knife is 8.75" long with a stainless steel blade and durable wooden handle.



01-1122 Fetlock Shears
Can be used in either hands with blades curving left or right. Stainless steel.



01-1123 Post Mortem Scissor
Heavy-duty scissors with one serrated edge. Sand caste, Stainless steel, length 7-3/4". Also available with black finished rings.

Hoof Rasps

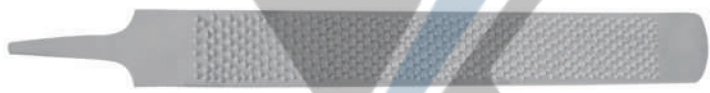

01-1124 Flat Rasp
A flat rasp with rasp cut on one side and double cut file on other. Super sharp. Length 36cm c/s.



01-1125 Flat Rasp
A flat rasp with rasp cut on one side and double cut file on other. Super sharp. Length 36cm c/s.



01-1126 Hoof Rasp X Style
Rasp teeth on one side with file teeth on other. Length 31cm c/s.



01-1127 Hoof Rasp X Style
Rasp teeth on one side with file teeth on other. Length 31cm c/s.



01-1128 Hoof Rasp
Rasp teeth on two side with file teeth on other. Length 31cm c/s.



01-1129 4-Way Hoof Rasp
The file has different filing grades: fine, medium fine, medium. This allows you to file the hooves to proper length while shaping and smoothing the rough and sharp edges. The 4-Way Hoof Rasp is the best tool for smoothing all areas of the animal's hooves. Length 35cm c/s.



HAGGAI

SURGICAL

Hoof & Claw Instruments



01-1130 Hoof Tester

Test hoof hardness with this popular, steel hoof tester with scored edges for better gripping. Available sizes 13", 13.25", 16" s/s.

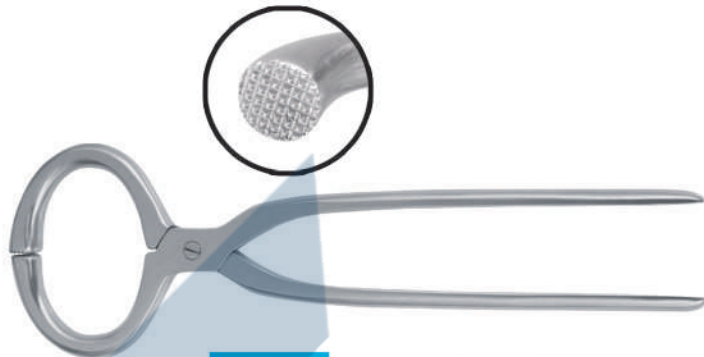

01-1131 Hoof Tester Heavy Duty

Available sizes 13", 13.5" s/s.

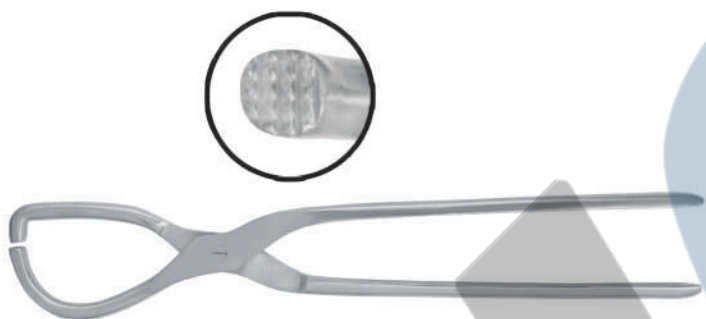

01-1132 Hoof Tester

Length 16" s/s.



01-1133 Large Hoof Tester

The large model has 12" reins, is 19" long and opens to 9.5". Stainless steel with pointed teeth.

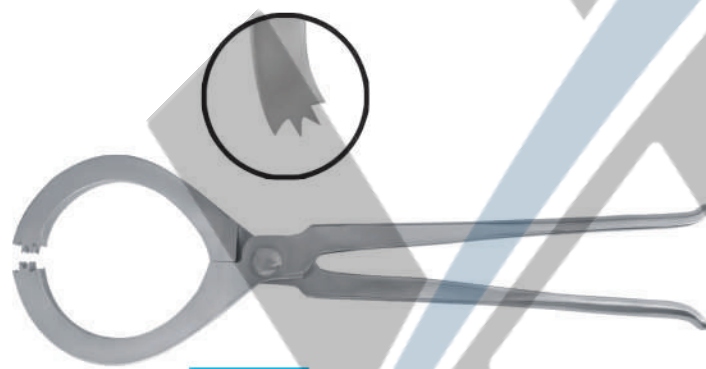

01-1134 Small Hoof Tester

The small model has 9" reins, is 15" long and opens to 7". Stainless steel with pointed teeth.

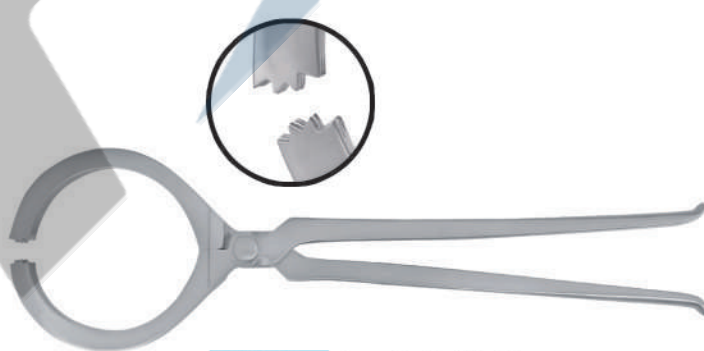

01-1135 Large Modified Hoof Tester

The modified model has 12" reins, is 19" long and opens to 9.5". Stainless steel with reduced teeth

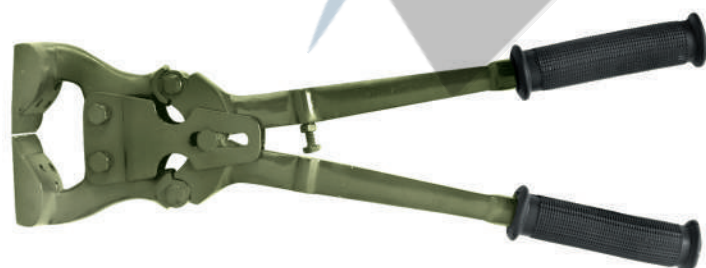

01-1136 Hoof Trimmer

Durable steel with bolted construction. Green protective coating covers the steel. 1-1/4" opening between trimmer blades with double compound action. Sharp blades are firmly attached with three recessed screws. Black rubber grip handles. Length 17" c/s.



01-1137 Nail Clipper

A nail clipper with sure-grip handles for cutting dogs nails. Stainless steel blades are designed to give precision cutting action. Flip-open safety lock protects cutting edge when not in use. 6-3/8" long.



HAGGAI

SURGICAL

Hoof & Claw Instruments



01-1138 Foot Rot Hoof Shear Carbon Steel
Carbon steel handles: Length 9.5".

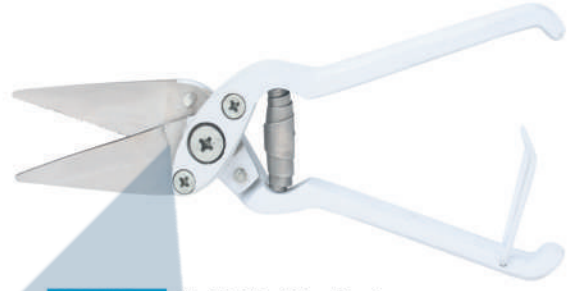

01-1139 Foot Rot Hoof Shear Aluminum
Ideal for both sheep and goat. Length 9.5".

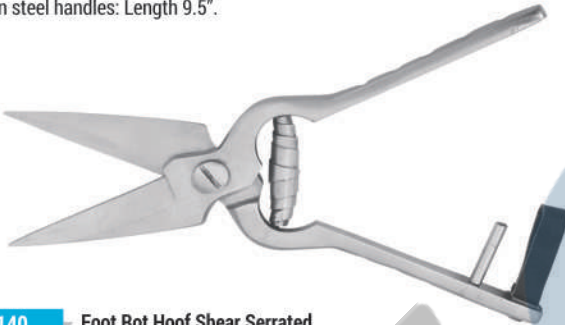

01-1140 Foot Rot Hoof Shear Serrated
Primarily used for sheep: Length 9" s/s.

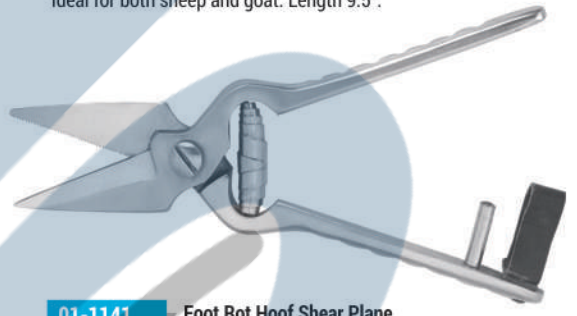

01-1141 Foot Rot Hoof Shear Plane
Available with plane blades and in leather holster 9" s/s.



01-1142 Trimming Shears
Red enameled handles with extra-large double bow Length 14".



01-1143 Single Bow Economy Sheep Shears
6" shearing blades. Overall Length 12".



01-1144 Hoof Pick-Vinyl Coated Handle
Sturdy, vinyl coated handle: Length 5.5" s/s.



01-1145 Hoof Pick Large - Vinyl Coated Handle
Pick with vinyl coated handle, s/s.



01-1146 Hoof Pick
Chrome plated steel rod hoof pick with a screw driver end which can be used to tighten Chicago screws.



01-1147 Hoof Knife Kit
Available in compact, elegant leather case with zipper. Set includes Wooden handle with 4 different types of Interchangeable blades.



01-1148 Hoof Knife Kit
Available in compact, elegant leather case with zipper. Set includes Wooden handle with 6 different types of Interchangeable blades.



Hoof & Claw Instruments

HAGGAI

SURGICAL

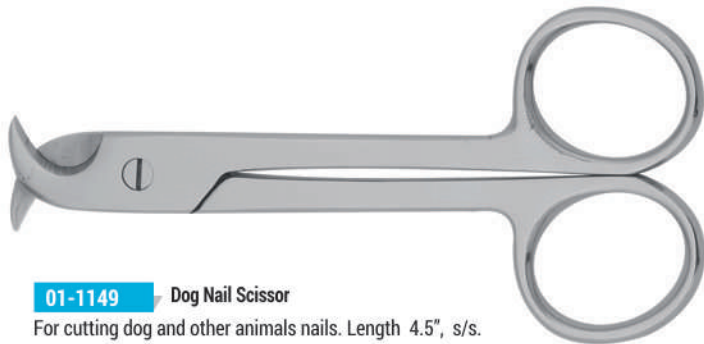

01-1149 Dog Nail Scissor
For cutting dog and other animals nails. Length 4.5", s/s.



01-1150 Cat Nail Scissor
For cutting cat nails. Length 3.5", s/s.



01-1151 Swiss Hoof Knife
Used for cutting and cleaning large areas of the sole in cattle and other large animals. Overall length: 7" s/s. Polished wooden grip.



01-1152 Hoof Knife
Double edged. Length 7.5" s/s. Polished wooden grip.



01-1153 Hoof Knife Small Size
Double edged. Length 6.5" s/s. Polished wooden grip



01-1154 Oval Hoof Knife
Available in wooden handle, can be used left or right handed.
Extra long shaft makes it easier and more accurate to use



01-1155 Oval Hoof Knife
Available in wooden handle, can be used left or right handed.



HAGGAI

SURGICAL

Hoof & Claw Instruments



Right

01-1156

Left

Hoof Knife Regular

Regular blade. This durable blade is held by two rivets in the hardwood handle and it extends 2" into handle. 1/2" blade at heel, 3" long, 8.5" long overall. Wooden grip. Available in left and right handed grip.



Right

01-1157

Left

Hoof Knife

Double edged. Polished wooden grip. Available in left and right handed grip.



Right

01-1158

Left

Hoof Knife

Polished wooden grip. Available in left and right handed grip.



Right

01-1159

Left

Hoof Knife

Narrow blade, Polished wooden grip. Available in left and right handed grip.



Right

01-1160

Left

Hoof Knife

Double edged. Polished wooden grip. Available in left and right handed grip.



Right

01-1161

Left

Hoof Knife

Curved blade. Polished wooden grip. Available in left and right handed grip.



Right

01-1162

Left

Hoof Knife

Extra long shaft makes it easier and more accurate to use. Polished wooden grip. Available in left and right handed grip.



Right

01-1163

Left

Hoof Knife

Narrow blade. Fine wooden grip. Available in left and right handed grip.



Hoof & Claw Instruments

HAGGAI

SURGICAL



Right **01-1164** Left

Hoof Knife

Wide blade. Fine wooden grip.
Available in left and right handed grip.



Right **01-1165** Left

Hoof Knife

Regular blade. Plastic grip.
Available in left and right handed grip.



Right **01-1166** Left

Hoof Knife

Double edged. Plastic grip.
Available in left and right handed grip.



Right **01-1167** Left

Hoof Knife

Double edged. Plastic grip.
Available in left and right handed grip.



Right **01-1168** Left

Hoof Knife

Narrow blade. Plastic grip.
Available in left and right handed grip.



Right **01-1169** Left

Hoof Knife

Narrow blade. Double edged. Plastic grip.
Available in left and right handed grip.



Right **01-1170** Left

Hoof Knife Backolyte Grip

Narrow blade. Backolyte grip.
Available in left and right handed grip.



Injectors & Extractors



01-1171 Europlex Syringe

Europlex metal gun syringe 30ml, 50ml sizes
(Also available with casing).

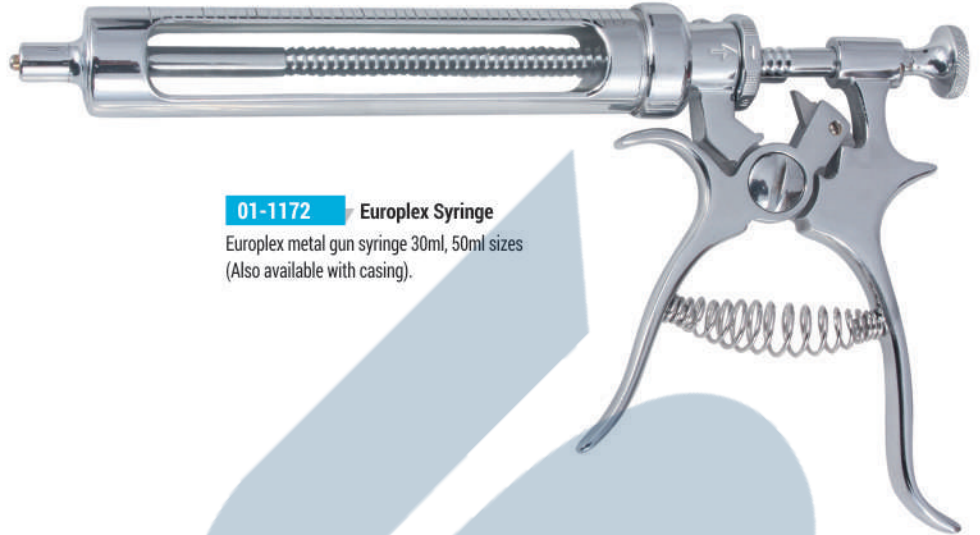

01-1172 Europlex Syringe

Europlex metal gun syringe 30ml, 50ml sizes
(Also available with casing).



01-1175 Automatic Syringe

Automatic Syringe
Available sizes: 5ml, 10ml, 15ml

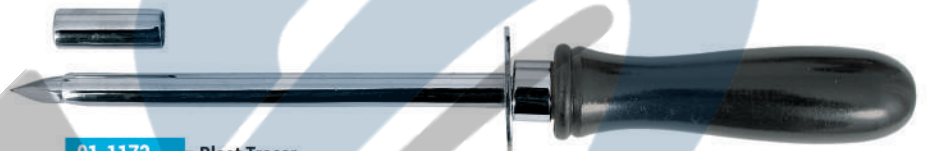

01-1173 Bloat Trocar

The flat-to-round shape has made this wooden-handled trocar very popular for venting animal gas accumulations. Includes stainless steel cannula and protector cap. Cannula length is 6". Also available in 5" length.



01-1174 Cattle Trocar

This cattle trocar is used to relieve bloating. Complete with cannula, a hollow tube which remains when trocar is withdrawn to allow gas to escape. Stainless point. Metal handle 9.5" L. Tube is 5-1/2" L. 3/8" I.D.



01-1176 Automatic Syringe

Automatic Syringe
Available sizes: 30ml

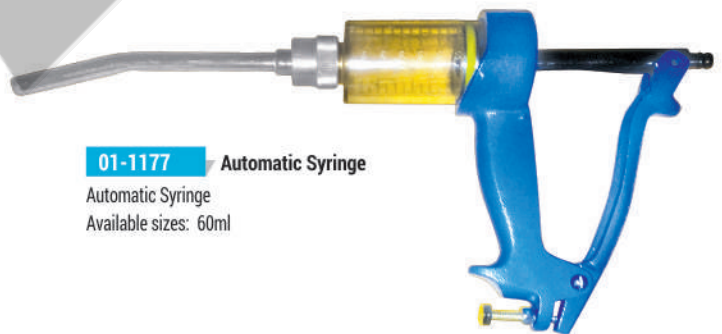

01-1177 Automatic Syringe

Automatic Syringe
Available sizes: 60ml

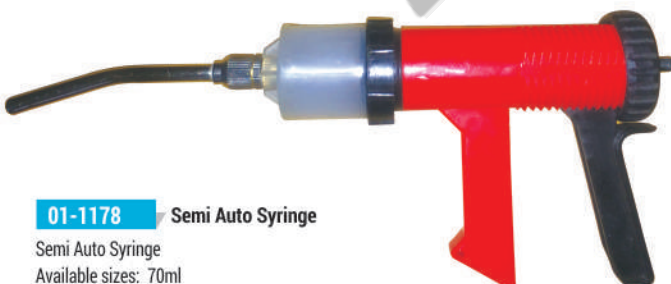

01-1178 Semi Auto Syringe

Semi Auto Syringe
Available sizes: 70ml

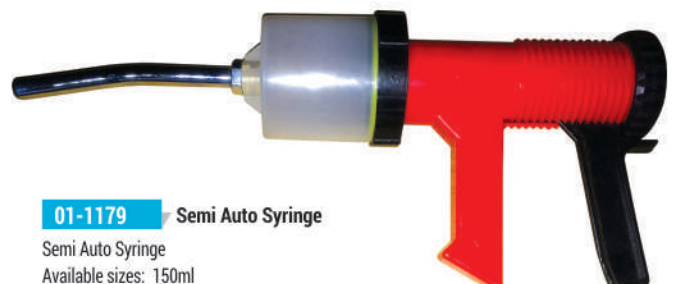

01-1179 Semi Auto Syringe

Semi Auto Syringe
Available sizes: 150ml



HAGGAI

SURGICAL

Obstetrical Instruments



01-1180 Krey Hook
Length 8" s/s.



01-1181 Linde's Embryotomy Knife
Length 5" s/s



01-1182 Ostertag's Eye Hook Blunt
Length 2", Hole Diameter 5/8" and Hook Length 3/4" s/s.



01-1183 Moore's OB Chain Handle
Stainless steel OB handle with one-piece construction. 5.5"



01-1184 Moore's OB Chain Handle
With Plastic Grip Handle aids in use of chains, 5.5" s/s.



01-1185 OB Wire Guide
The instrument will bring your wire around any tight or difficult location on the fetus. Length 7" s/s.

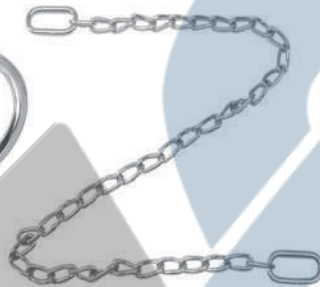

01-1186 OB Chain
Heavy duty obstetrical chains assist in the delivery of the calves. Length 60" s/s.



01-1187 OB Chain
Heavy duty obstetrical chains assist in the delivery of the calves. Length 30" s/s.



01-1188 Swine Cable OB Snare
This durable, swine cable obstetrical snare is made from aircraft cable. Overall length 18" s/s.

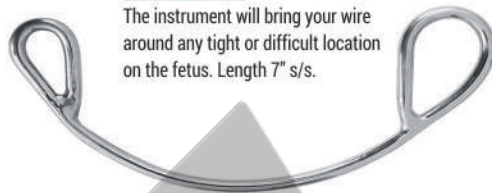

01-1189 OB Wire Guide
The instrument will bring your wire around any tight or difficult location on the fetus. Length 9" s/s.

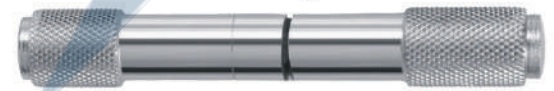

01-1190 Sutter OB Handle
Knurled non-slip grip. Length 4" c/s.

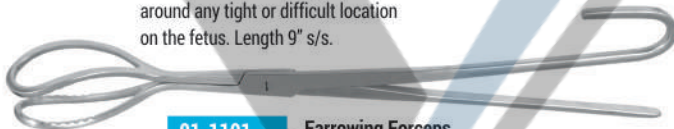

01-1191 Farrowing Forceps
Farrowing Forceps For Piglets. Length 20.5" s/s.



01-1192 Farrowing Snare
Shaped end allows operator to direct head after cable is placed behind ears or legs. Length 15" c/s.

Plaster Instruments



01-1193 Cast Spreader
Cast spreaders with 5cm wide blades. Available sizes 10.5", 11" s/s.



01-1194 Cast Spreader (Henning)
3-Pong cast spreader 9". Spring-loaded handle for one-hand operation. cutting beyond cast thickness.



01-1195 Plaster Shears
Available size 17.25" s/s.



HAGGAI

SURGICAL

Plaster Instruments



01-1196 Plaster Shears
Plaster shears with serrated blades.



01-1197 Plaster Shears (Brun/Bohler)
They can cut through cloth, plastic and metal. They have serrated blades for non-slip cutting. Stainless steel. Length 10"

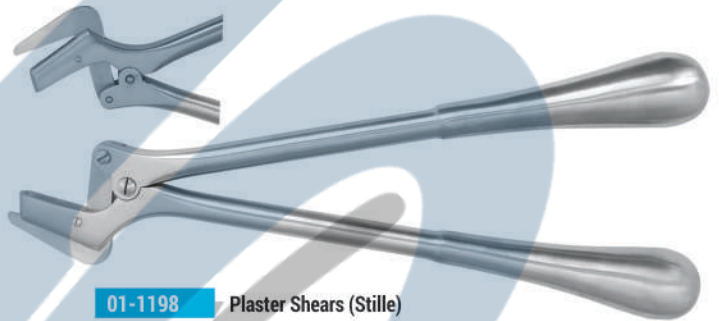

01-1198 Plaster Shears (Stille)
Plaster shears with serrated blades. Available sizes 9", 10" 15" s/s.



01-1199 Ring Cutter 16 cm



01-1200 Universal Scissors
It can cut through almost anything: a multitude of uses around any clinic. Autoclavable. Stainless steel: Length 7.5", 5.5".

Snake Catchers

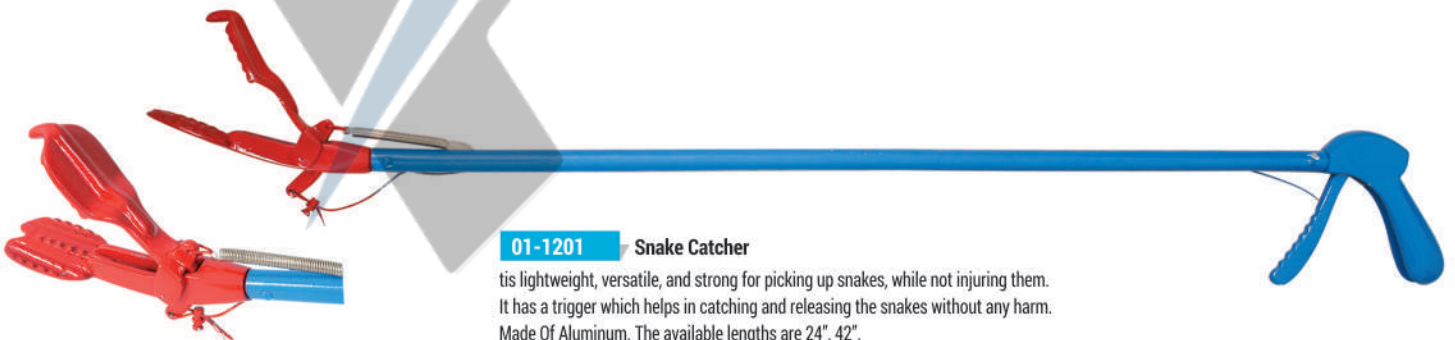

01-1201 Snake Catcher
It's lightweight, versatile, and strong for picking up snakes, while not injuring them. It has a trigger which helps in catching and releasing the snakes without any harm. Made Of Aluminum. The available lengths are 24", 42".



01-1202 Snake Hook
Made of Aluminum. The rubber grip increases the hold in case of a wet conditions. The available lengths are 24", 30", 36", 48".



HAGGAI

SURGICAL

Restraining Instruments



01-1203 Premium Hog Holder With Lock
An improved hog holder made of 3/16" galvanized aircraft cable with a cable stop that avoids kicking. Durable, high-strength tubing of carbon steel, nickel-plated.



01-1204 Ring-O-Matic Hog Catcher
Snares and holds any weight hog. Loop is constructed of galvanized aircraft cable and the handle is coated with a rust-resisting finish. Handle is 22" in length with a 20" loop of aircraft cable.



01-1205 Shorty Hog Holder
Easy, quick way to control pigs in tight spaces. Comfort-grip rubber handle with galvanized aircraft cable loop. Approximately 8" long.

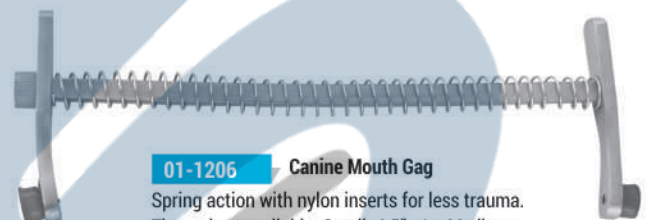

01-1206 Canine Mouth Gag
Spring action with nylon inserts for less trauma. Three sizes available: Small: 4.5" s/s, Medium: 5.75" s/s, Large: 6.25" s/s.
R-1615



01-1207 Cattle Twitch / Nose Twitch
For help in restraining horses or cattle. Nylon coated handles for firm grip. Length 17" s/s.

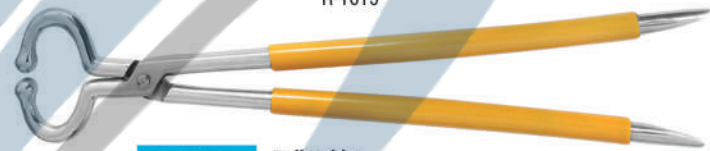

01-1208 Bull Holder
Stainless steel sand casted. PVC grip. Available sizes 14", 15" s/s.



01-1209 Bull Lead With Chain
Place stainless steel lead into animal's nostrils and close gently. Secure handles with heavy-duty 13 1/2" chain. Also available without chain.



01-1210 Harm's Bull Holder
Made of Stainless steel.



01-1211 Cattle Leader Aluminum
The ideal type lead for show animals - gives the nose a shorter appearance than other type leads. Made of strong, Permits animal to eat without removal. 2-1/2" x 1-1/4" x 3-3/4" L.



01-1212 Cattle Leader Brass
The ideal type lead for show animals - gives the nose a shorter appearance than other type leads. Permits animal to eat without removal.



01-1213 Heavy Duty Bull Lead
With coiled spring and protective release sleeve. Made of Stainless Steel.



01-1214 Kantslip Cattle Lead
Made with fine quality holding spring. Opens to approximately 2-5/8". Overall width 3", overall length 5" brass, c/p.



HAGGAI

SURGICAL

Restraining Instruments



01-1215 Shepherds Crook Neck & Leg Model
It has a 2 way use and rubber grips for strong hold. Length 57".



01-1216 Shepherds Crook Leg Model
It has rubber grip for strong hold. Length 53".



01-1217 Calf Weaner Plastic
Durable red plastic, more comfortable for livestock. Flexible material and a fixing screw ensure easy adjustment and a perfect fixing in the cattle's nose.



01-1218 Milk Sucking Preventor / Calf Weaner Metal
Guard swings free allowing animal to eat and drink freely, yet prevents sucking. Nose piece is adjustable to nose separation of the animal then locked in place by tightening the wing nut, Aluminum.



01-1219 Milk Sucking Preventor / Calf Weaner Metal
Guard swings free allowing animal to eat and drink freely, yet prevents sucking. Made of Aluminum.



01-1220 Anti Kick Device
Made of silver, sand-cast, powder coated, screw made of carbon steel.



01-1221 Dog Muzzle A - B
This well-fitting, comfortable muzzle is made based on special strong metallic construction to maintain the shape of the muzzle and to assure long life for the muzzle. Powder coating makes this muzzle rust resistant. Due to great design the muzzle provides the dog with best ventilation. Also available in stainless steel without powder coating.



01-1222 Dog Muzzle A - B



01-1223 Anti Kick Bar / Kick-Stop Cow Immobilizes
Fits any size animal by means of an easy, push button. Just slip over back and thigh area and push the button to reach proper adjustment. When in position, the animal will not kick its hind legs.



01-1224 Equivet Full Mouth Speculum
Made of Stainless steel sand-cast. Adjustable straps for secure fit to the horse. Stainless steel spring loaded ratchets on both sides of speculum keep the mouth open at the desired setting during use. This sturdy full mouth speculum comes with upper and lower tooth plates.



HAGGAI

SURGICAL

Ring Applicators

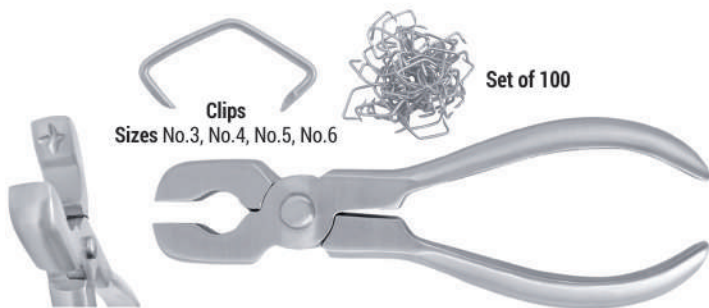

Clips
Sizes No.3, No.4, No.5, No.6

Set of 100

01-1225 Snout Pig Ring Applicator
Sand cast, Stainless steel snout pig ring applicator. Length 6" s/s.

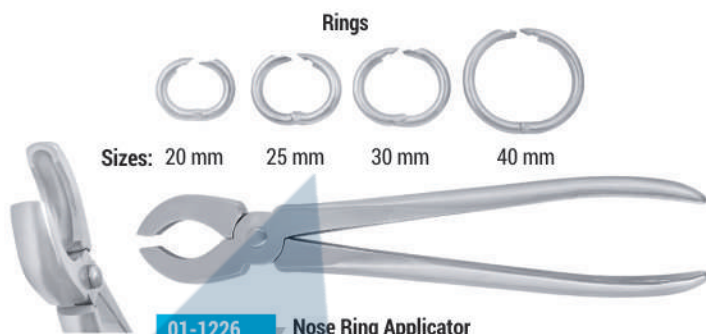

Rings

Sizes: 20 mm 25 mm 30 mm 40 mm

01-1226 Nose Ring Applicator
Make pig ringing quick, easy and painless. Rings go between nostrils. Length 10".



01-1227 Bull Nose Punch
For piercing the bull's nose cartilage prior to insertion of the nose ring. This tool makes the job more animal friendly.



01-1228 Bull Ring Applicator Economy
This metal applicator will do rings up to 77mm x 10mm (3 inch) Length overall is 11".



01-1229 Bull Ring Applicator Heavy Duty
Stainless Steel bull ring applicator. Excellent Quality. This is a far superior product than the standard steel applicators.



01-1230 Bull Ring Stainless
The special sharp cutting points pierce the nasal septum easily with no pre-incision. Size's Available: 2", 2.5", 3", 3.5".



01-1231 Bull Ring Brass
Brass bull ring is self-piercing and extremely durable. A long, sharp piercing point ensures a clean cut. Size's Available: 2", 2.5" 3", 3.5"

Teat Instruments



01-1232 Teat Slitter
Opens test sphincter for greater milk flow. Available with loops. Length 8", brass and s/s.

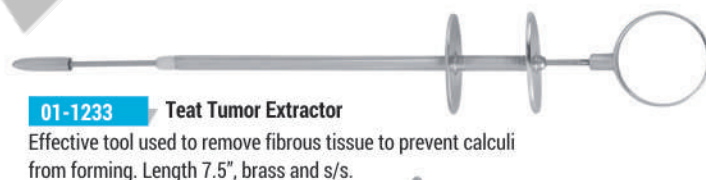

01-1233 Teat Tumor Extractor
Effective tool used to remove fibrous tissue to prevent calculi from forming. Length 7.5", brass and s/s.



01-1234 Hug's Teat Tumor Extractor
Effective tool used to remove fibrous tissue to prevent calculi from forming: Length 6", brass and s/s.



01-1235 Danish Teat Slitter
Extra thin model. Blades are opened by loosening the small burr on side of the instrument: Length 7.5", brass and s/s.



01-1236 Cornell teat curette
Stainless steel with spiral cutting edge 6"



01-1237 Teat Syphons
Milking Tube Length 3.75", brass and s/s.



01-1238 Hug's Teat Knife / Teat Lancet
Length 6", blade 0.5", s/s.



01-1239 Sudan Blood Taking Needle
Length 3.5", brass and s/s.



01-1240 Milking Tube
Length 4.25", brass and s/s.



HAGGAI

SURGICAL

Vaginal Specula

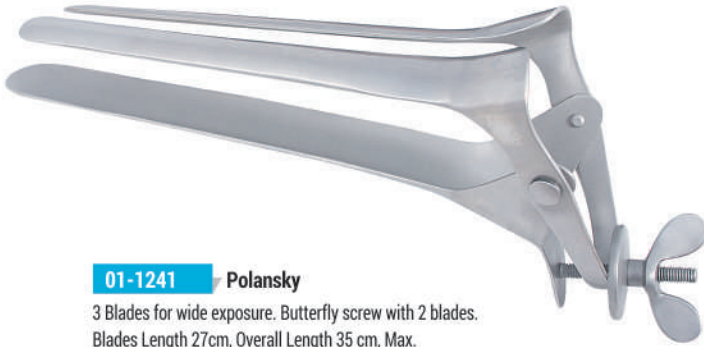

01-1241 Polansky

3 Blades for wide exposure. Butterfly screw with 2 blades.
Blades Length 27cm, Overall Length 35 cm, Max.
opening 10 cm, s/s.

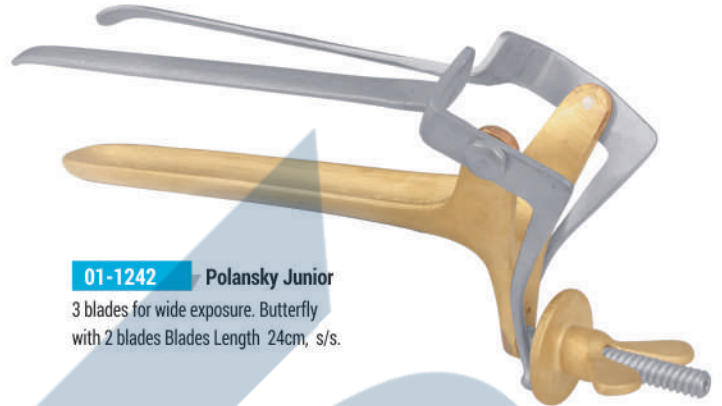

01-1242 Polansky Junior

3 blades for wide exposure. Butterfly
with 2 blades Blades Length 24cm, s/s.

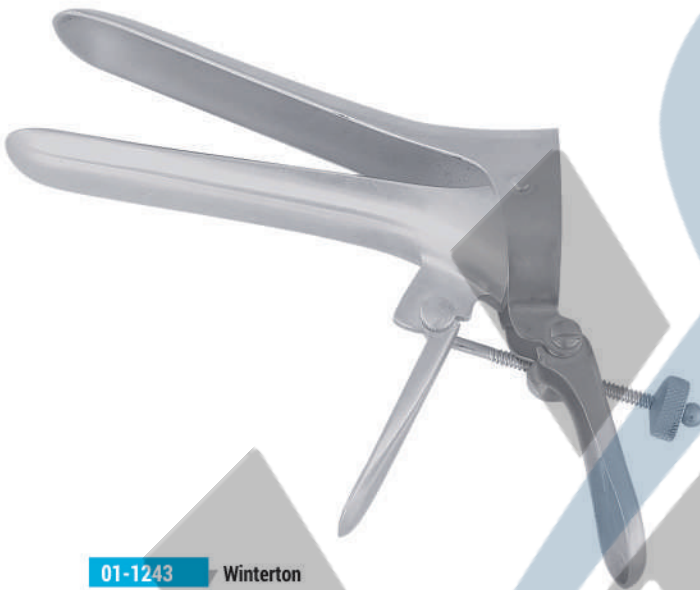

01-1243 Winterton

Blades Length 10cm, s/s.



01-1244 Russian

Blades Length 23cm, s/s.



01-1245 Graves

Blades Length 15cm, s/s.



HAGGAI

SURGICAL

Snaffles. Dee. Ring Snaffle Bits



02-1246 Rings stainless steel
4" to 5-1/2" mouth size available. Ring varies from 45mm to 75mm.



02-1247 Rings stainless steel
Mouth and rings made of stainless steel.



02-1248 Rings stainless steel
Rings stainless steel. Mouth german steel.



02-1249 Rings stainless steel
Rings stainless steel. Mouth carban steel with leather cover.



02-1250 Rings stainless steel
Stainless steel rings. Mouth made of rubber.



02-1251 Rings stainless steel
D bit with 5" rubber covered mouth. Stainless steel. Also available in chrome plating.



02-1252 D ring snaffle
made of stainless steel. 4-1/2" to 5-1/2" mouth sizes available.



02-1253 Rings stainless steel
Stainless steel. mouth made of german steel including chain.



02-1254 Rings stainless steel
Rings and mouth made of stainless steel.



02-1255 Ring Stainless steel
Stainless steel rings. Link and mouth made of stainless steel.



02-1256 Ring Stainless steel
Stainless steel rings. Link made of red copper. Stainless steel mouth.

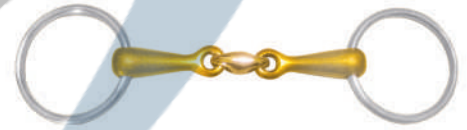

02-1257 Ring Stainless steel
Stainless steel rings. Link and mouth made of red copper.



02-1258 Ring Stainless steel
Brass rings. Link and mouth made of brass.



02-1259 Ring Stainless steel
Stainless steel.



02-1260 Ring Stainless steel
Stainless steel. Mouth made of german steel.



02-1261 Ring Stainless steel
Stainless steel.



02-1262 Ring Stainless steel
Stainless steel.



02-1263 Ring Stainless steel
Stainless steel. Mouth german steel including chain.



02-1264 Ring Stainless steel
Stainless steel.



02-1265 Ring Stainless steel
Link german silver. Mouth made of stainless steel.



02-1266 Ring Stainless steel
Stainless steel pelham including chain.



HAGGAI

SURGICAL

Snaffles.Deer.Ring Snaffle Bits



02-1267 Snaffle Bits
Stainless steel including chain.

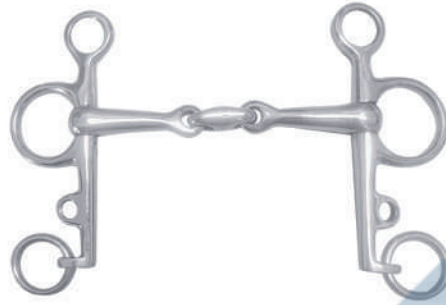

02-1268 Snaffle Bits
Stainless steel.Link german steel including chain.

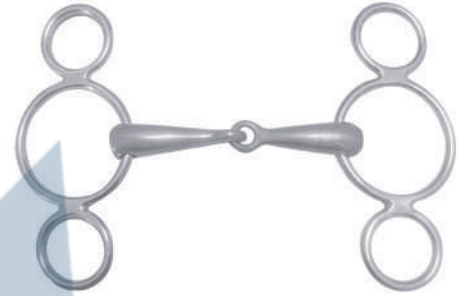

02-1269 Snaffle Bits
Rings stainless steel. Mouth german steel.

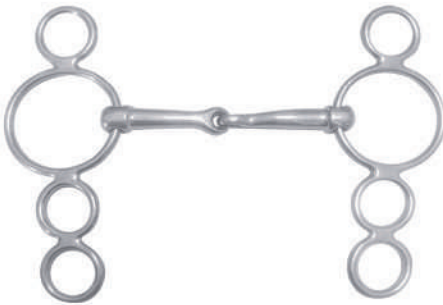

02-1270 Snaffle Bits
Rings and mouth made of stainless steel.

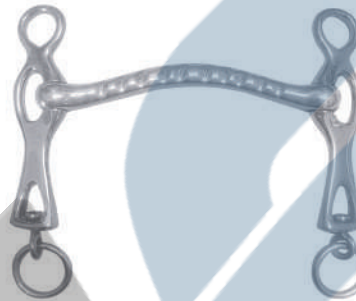

02-1271 Snaffle Bits
Stainless steel including chain.

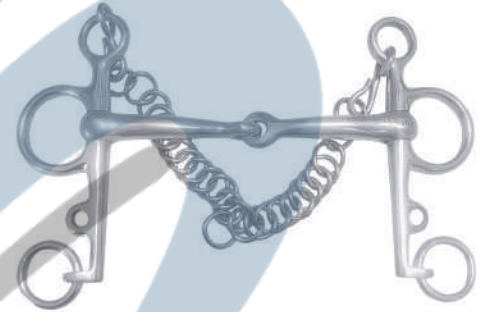

02-1272 Snaffle Bits
Rings stainless steel. Rubber covered mouth.

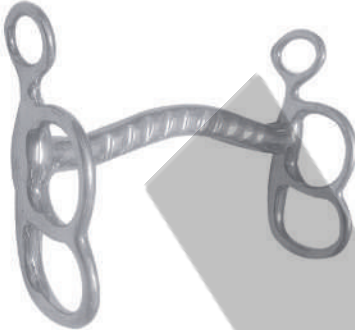

02-1273 Snaffle Bits
Stainless steel including chain.



02-1274 Snaffle Bits
Stainless steel hollow mouth including chain.



02-1275 Snaffle Bits
Stainless steel.



02-1276 Snaffle Bits
Stainless steel.

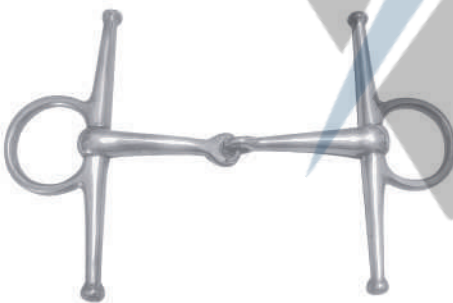

02-1277 Snaffle Bits
Full cheek with stainless steel mouth.

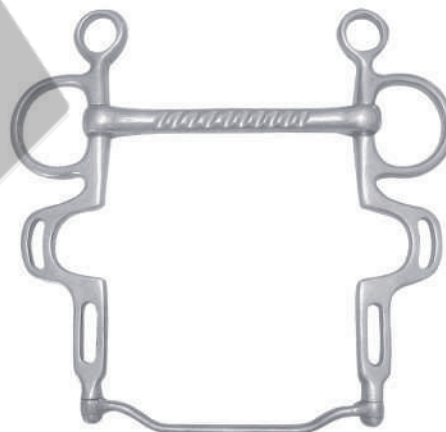

02-1278 Snaffle Bits
Stainless steel.

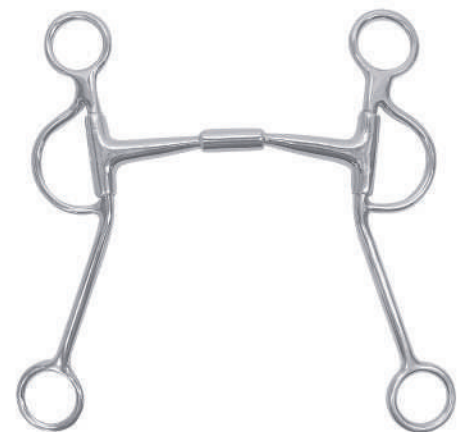

02-1279 Snaffle Bits
Stainless steel.



HAGGAI

SURGICAL

Spurs and Stirrups



02-1280 Spurs Stainless Steel
Stainless steel spurs with brass buttons and rowel.
Also available in chrome plating. 2pcs set.



02-1281 Spurs Stainless Steel
Stainless steel spurs. 2pcs set.



02-1282 Spurs Stainless Steel
Classic hunt and jump spurs in the popular loop end style. Stainless steel. 2pcs set.



02-1283 Spurs Stainless Steel
Fine engraving with loop end style.
Stainless steel. 2pcs set.



02-1284 Spurs Stainless Steel
Stainless steel spurs. Gold plated. 2pcs set.

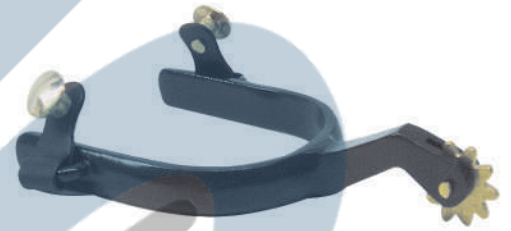

02-1285 Spurs Stainless Steel
Carbon steel spurs with powder coating. Buttons and rowel made of brass.



02-1286 Spurs Stainless Steel
Carbon steel spurs powder coated with brass buttons.
16 point rowel. 2pcs set.



02-1287 Spurs Stainless Steel
Brass spurs with 10 point rowel. 2pcs set.



02-1288 German steel stirrup
Including rubber, 2pcs set.
Sizes Available: 4", 4 1/4", 4 1/2", 4 3/4", 5".



02-1289 Stainless steel stirrup
Including rubber, 2pcs set.
Sizes Available: 4", 4 1/4", 4 1/2", 4 3/4", 5".



02-1290 Stirrup
Stainless steel stirrup, flexible.
Including rubber, 2pcs set.



02-1291 Stainless steel stirrup
Including rubber, 2pcs set.
Sizes Available: 4", 4 1/4", 4 1/2", 4 3/4", 5".



02-1292 Stainless steel stirrup
Including rubber, 2pcs set.
Sizes Available: 4", 4 1/4", 4 1/2", 4 3/4", 5".



02-1293 Stainless steel stirrup
Stainless steel stirrup, including rubber, 2pcs set.
Sizes Available: 4", 4 1/4", 4 1/2", 4 3/4", 5".



02-1294 Stainless steel stirrup
Stainless steel stirrup, including rubber, 2pcs set.
Sizes Available: 4", 4 1/4", 4 1/2", 4 3/4", 5".



02-1295 Stainless steel stirrup
Especially designed for polo players.
Sizes Available: 4", 4 1/4", 4 1/2", 4 3/4", 5".



02-1296 Rubber for stirrups
Rubber for stirrups. 2pcs set.



HAGGAI

SURGICAL

Halters & Reins



02-1297 Halters & Reins
Nylon halter for cows.



02-1298 Halters & Reins
Genuine leather halter with brass rings.



02-1299 Halters & Reins
Genuine leather halter with brass rings.



02-1300 Halters & Reins
Fancy halter with brass c/p rings, Genuine leather.



02-1301 Halters & Reins
Bridle made of genuine leather. Including rein.



02-1302 Halters & Reins
Leather bridle including rein made of cotton.



02-1303 Halters & Reins
Leather bridle including rein made of leather.



02-1304 Halters & Reins
Rein made of cotton 100" to 110".



02-1305 Halters & Reins
Rein made of leather 100" to 110".



02-1306 Halters & Reins
Leather stirrup 52" to 58".



02-1307 Halters & Reins
Nylon halter with brass plated hardware.
Available sizes: Small, Medium, Large.



02-1308 Halters & Reins
Nylon halter with c/s, c/p hardware.
Available sizes: Small, Medium, Large.



02-1309 Halters & Reins
Nylon halter with c/s, c/p hardware.
Available sizes: Small, Medium, Large.



HAGGAI

SURGICAL

Horse Measuring-Walking Sticks & Hinge Cribbing



02-1310 Horse Measuring-Walking Sticks

Made of cane and Aluminum. Measure extends to 18hh, extending arm with spirit level. Ideal for measuring horses.

02-1311 Horse Measuring-Walking Sticks

Made of cane and Aluminum. Measure extends to 18hh, extending arm with spirit level. Ideal for measuring horses.

02-1312 Hinge Cribbing With Leather Strap

Made of Aluminum. Quality leather adjustable strap. Double and sewn. Durable steel buckle. Also available with nylon strap.



Arctic Quilt Blankets



02-1313 Arctic Quilt Blankets

Outer layer parachute. Filled with polyester and foam. Lining polyester. Available sizes 47", 63" and 70". Available colors: Green/red trim, Black/red trim, Red/black trim, Grey/black trim, Sky Blue/sky blue trim, Black/white trim, Green/white trim, Navy Blue/white trim, Red/white trim, White/black trim, Royal Blue white trim, Maroon/white trim . SPECIFY COLOR.



02-1314 Arctic Quilt Blankets

Made of pure cotton. Available colors: Black/red trim, Red/black trim, Grey/black trim, Sky Blue sky blue trim, Black/white trim, Green/white trim, Navy Blue /white trim, Red/white trim, White black trim, Royal Blue/white trim, Maroon/white trim . SPECIFY COLOR.

Chariot Chains

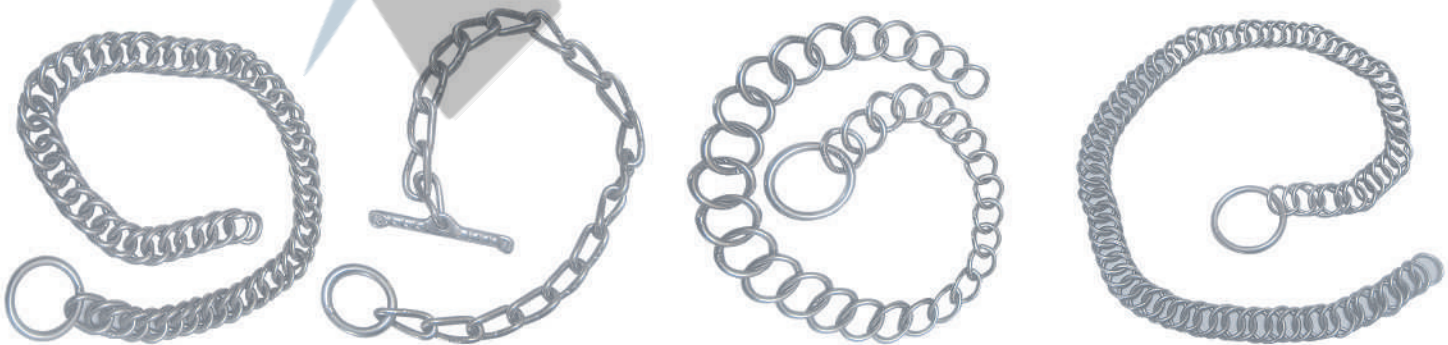

02-1315 Chariot Chains

Stainless steel, Length 40".

02-1316 Chariot Chains

Stainless steel, Length 40".

02-1317 Chariot Chains

Stainless steel, Length 40".

02-1318 Chariot Chains

Stainless steel, Length 40".



HAGGAI

SURGICAL

Girths



02-1319 Cotton Girth
 Made with a special soft cotton cover and comfortably padded. Heavy nylon straps, washable. Specify size and color 46" to 54". Black, Brown and Chestnut. Elastic ends.



02-1320 Cotton Girth
 Made of finest cotton web. Excellent for show horses or a good school girth. Specify size 46" to 54".



02-1321 Cotton Girth
 Made of finest cotton web. Specify size 46" to 54".



02-1322 Cotton Girth
 Made of finest cotton web. Specify size 46" to 54".



02-1323 Leather Girth
 Quality leather girth with belly guard to protect horse from injury. Elastic ends. Carbon steel c/p roller buckles. Black and Brown. 46" to 54". Specify size.



02-1324 Cotton Girth
 Plain end leather girth. Specify size and color 46" to 54". Black, Brown.

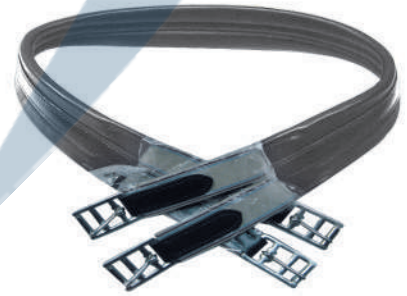

02-1325 Cotton Girth
 Made of premium quality leather with a reinforcing strip stitched down the back and elastic at both ends. With four buckles. Size 46" to 54".



02-1326 Leather Girth
 Genuine leather with elastic at one end. Specify size and color 46" to 54". Black, Brown.

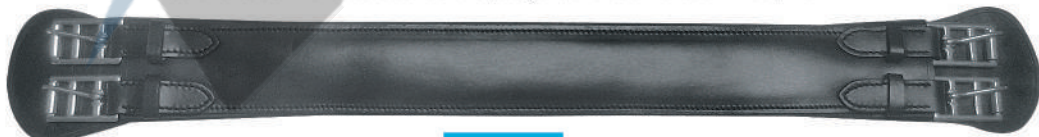

02-1327 Dressage Girth
 Dressage style girth made of softchoice leather in black. Designed for long billet saddles. Specify size and color 46" to 54". Black, Brown.



02-1328 Dressage Girth
 Dressage girth, Genuine leather. Specify size and color 46" to 54". Black, Brown.



HAGGAI

SURGICAL

Polo Wraps-Track Bandages



02-1329



Polo Wraps / Track Bandages

A quality bandage for racing, hunt and polo. Elastic support combined with fleece makes this bandage not only protective but resilient and shock resistant. 5" wide 4 meter. Packed per set of 4.



02-1330



Lunge Lines



02-1331



02-1332

Nylon Lunge Lines

Made of 1" wide poly web. 26 feet length. Heavy duty carbon steel chrome plated and brass snap.



02-1333



02-1334



02-1335

Cotton Lunge Lines

Heavy ribbed cotton webbing that is easy to grip and comfortable to the hands. Heavy duty chrome plated and brass snap.



02-1336

Leather Lunge Lines

Heavy ribbed Leather webbing that is easy to grip and comfortable to the hands. Heavy duty chrome plated and brass snap.



02-1337

Cotton Lunge Lines

Made of 1" wide poly web. 5 feet length. Brown, Blue, Orange, Navy, Blue, Green, Red and Black. Specify color. Heavy duty carbon steel chrome plated snap.

Cattle Lead & Rope Hag Nets



02-1338

Cattle Lead

Hook made of steel and brass. Length 6 feet.



02-1339

Cattle Lead

Hook made of steel and brass. Length 6 feet.

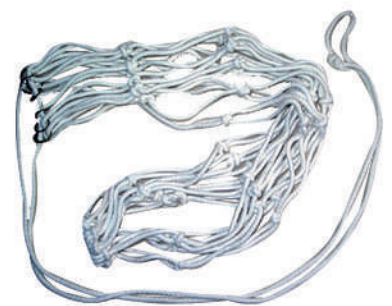

02-1340

Rope Hay Nets

White cotton which is much safer than nylon. Perfect for your horse trailer and around the barn.



HAGGAI

SURGICAL

Seat Stick & Shipping Boots



02-1341 Seat Stick

Light weight metal. Hinged ground plate to prevent sinking in soft ground. Excellent for shows, rallies etc.



02-1342 Seat Stick

Light weight metal. Hinged ground plate to prevent sinking in soft ground. Excellent for shows, rallies etc.



02-1343 Shipping Boots

Contour fit and super thick to provide ultimate security, protection and comfort. Color Available Grey, Dark Grey, Royal Blue, Navy Blue.

Saddle Pads & Dog Belts



02-1344 QUILTED COTTON COMFORT SADDLE PADS

100% Cotton twill pad featuring an inner layer of foam padding for excellent protection. Quilted mini diamond pattern 1" size. Nylon girth/billet straps. Washable. Available in Green, Black, Navy Blue, Red, White, Royal Blue, Maroon. SPECIFY COLOR.

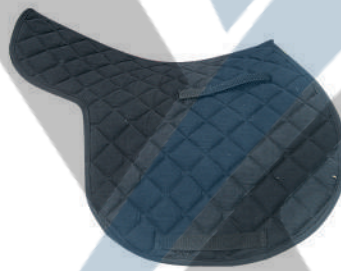

02-1345 QUILTED COTTON COMFORT SADDLE PADS

100% Cotton twill pad featuring an inner layer of foam padding for excellent protection. Quilted diamond pattern 2" size. Nylon girth/billet straps. Washable. Available in Green, Black, Navy Blue, Red, White, Royal Blue, Maroon. SPECIFY COLOR.



02-1346 QUILTED COTTON COMFORT SADDLE PADS

100% Cotton twill pad features a shock absorbing insulation between layers. Your horse can tell the comfort difference. An inner layer of foam padding for excellent protection. Quilted diamond pattern 2" size. Washable. Available colors for Nylon girth



02-1347 QUILTED COTTON COMFORT SADDLE PADS

100% Cotton twill pad features a shock absorbing insulation between layers. Your horse can tell the comfort difference. An inner layer of foam padding for excellent protection. Quilted diamond pattern 2" size. Washable. Available colors for Nylon girth / billet straps: Sky Blue, Green, Black, Red, Maroon and Royal Blue. SPECIFY COLOR. Available colors: Sky blue/sky blue trim, Red/black trim, Black/red trim, Grey/black trim, Sky Blue.



02-1348 QUILTED COTTON COMFORT SADDLE PADS

100% Cotton twill pad features a shock absorbing insulation between layers. Your horse can tell the comfort difference. An inner layer of foam padding for excellent protection. Quilted mini diamond pattern 1" size. Washable. Available colors for Nylon girth / billet straps: Green, Black, Red, Sky Blue, Maroon and Royal Blue. SPECIFY COLOR.



02-1349 QUILTED LEATHER COMFORT SADDLE PADS

Synthetic leather amara. Diamond pattern 2" size. Available colors for Nylon girth / billet straps: Green, Black, Red, Sky Blue, Maroon and Royal Blue. SPECIFY COLOR. Available colors: Red/black trim, Black/red trim, Grey/black trim, Sky Blue/ sky blue trim, Black/white trim, Green/white trim, Navy Blue /white trim, Red/white trim, White black trim, Royal Blue/white trim, Maroon/white trim . SPECIFY COLOR.



02-1350 Hunting Hound Belt



02-1351 Dog Belt



HAGGAI

SURGICAL

Saddles



02-1352 SADDLES

Close Contact English Saddle. Ideal for jumping or riding on the flat. Made from premium quality leather. Includes safety stirrup bars and nylon reinforced billets. Fits almost any breed. (16 ½", 17", 17 ½")



02-1353 SADDLES

Close Contact English Saddle. Ideal for jumping or riding on the flat. Made from premium quality leather. Includes safety stirrup bars and nylon reinforced billets. Fits almost any breed. (16 ½", 17", 17 ½")



02-1354 SADDLES

Close Contact English Saddle. Ideal for jumping or riding on the flat. Made from premium quality leather. Includes safety stirrup bars and nylon reinforced billets. Fits almost any breed. (16 ½", 17", 17 ½")



02-1355 SADDLES

Close Contact English Saddle. Ideal for jumping or riding on the flat. Made from premium quality leather. Includes safety stirrup bars and nylon reinforced billets. Fits almost any breed. (16 ½", 17", 17 ½")



02-1356 SADDLES

Close Contact English Saddle. Ideal for jumping or riding on the flat. Made from premium quality leather. Includes safety stirrup bars and nylon reinforced billets. Fits almost any breed. (16 ½", 17", 17 ½")



02-1357 SADDLES



02-1358 CLOSE CONTACT ENGLISH SADDLE

Close Contact English Saddle. Ideal for jumping or riding on the flat. Made from premium quality leather. Includes safety stirrup bars and nylon reinforced billets. Fits almost any breed. (16 ½", 17", 17 ½")



02-1359 SADDLES

Close Contact English Saddle. Ideal for jumping or riding on the flat. Made from premium quality leather. Includes safety stirrup bars and nylon reinforced billets. Fits almost any breed. (16 ½", 17", 17 ½")



02-1360 SADDLES

Close Contact English Saddle. Ideal for jumping or riding on the flat. Made from premium quality leather. Includes safety stirrup bars and nylon reinforced billets. Fits almost any breed. (16 ½", 17", 17 ½")



HAGGAI

SURGICAL

Horse Riding Gloves



02-1361 Spandex Kidskin

Made of the softest sweat proof leather, The spandex knitted elastic back has "quick grip" fasteners on the wrist band for easy on and off. Ladies one size fits all. Black or natural. Specify color.



02-1362 Leather Riding Gloves

These riding gloves are hand crafted and incredibly strong genuine lamb skin. Quick-grip closure. Leather reinforced wear points. Ladies: Small/medium, Large X-large. Brown or black. Men's: Medium/Large, Large/ X-large. Black only.



02-1363 Leather/Spandex Gloves

This popular glove offers close contact on the rein. Made of 4 way stretch spandex/spandex "massage action" material with soft, supple leather palm. Elastic wrist with "quick grip" tabs for easy on and off. Specify color. Burgundy, navy and black. One size fits all in child's, ladies or men's.



02-1364 Open Back Capeskin

These supple capeskin gloves feature open backs with adjustable "quick grip" fasteners. Black only. One size fits all in child's, ladies or men's size.



02-1365 Eshal Gloves

Palm-black ammara, back spandex.



02-1366 Riding Gloves

Palm made of cow (naked) brown, back made of spandex.



HAGGAI

SURGICAL

Horse Riding Gloves



02-1367 Leather/Neoprene Gloves

Leather reinforced palm, elastic grip with quick grip closure. Available in blue color.



02-1368 Leather/Neoprene Gloves

Leather reinforced palm, elastic grip with quick grip closure. Available in burgundy color.



02-1369 Leather/Neoprene Gloves

Fine leather and cotton embroidery. Available in Small, Medium & Large sizes.



02-1370 Lambskin Gloves

For those who appreciate quality, these riding gloves are hand crafted and incredibly strong genuine lambskin. Leather reinforced wear points. Ladies: Small/medium, large/x-large. Brown or black. Men's: Medium/large, large/x-large. Black only.



02-1371 Leather/Neoprene Gloves

This new design offers warmth and flexibility on those cool days. Leather reinforced palm, elastic wrist with quick grip closure. Available in blue color.



HAGGAI

SURGICAL

Splint Boots and Whips Crops & Bats



02-1372

Heavy rubber exterior and lined with PVC neoprene. Splint area protected with extra padding. Quick-grip closures. Has adjustment to fit many different size horses. For rear leg use. Available Sizes: Small, Medium, Large.

02-1373

Made with neoprene and velcro fasteners. Provides extra padding to the tendon area from stick and ball without constricting the joint. Easy to use. Easy to wash. For front leg use. Available Sizes: Small, Medium, Large.



02-1374

Heavy rubber exterior and lined with PVC neoprene. Splint area protected with extra padding. Quick-grip closures. Has adjustment to fit many different size horses. For front leg use. Available Sizes: Small, Medium, Large.



02-1375

Kneepads for polo players- 2 strap velcro provides safety and comfort. Also features closed cell foam padding for the ultimate in protection. Also available with 3 strap velcro and buckles for extra strength.

02-1376

02-1377

02-1378

02-1379



HAGGAI

SURGICAL

Surgical Forceps



03-1380

Halstead Mosquito Forcep Str/Cvd
Size: 13cm



03-1381

Spencer Wells Forceps Str/Cvd
Size: 12.5cm, 15cm, 18cm

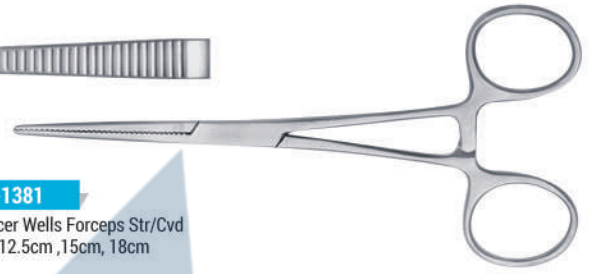

03-1382

Crile Artery Forceps Str/Cvd
Size: 14cm



03-1383

Rochester Pean Artery Forceps Str/Cvd
Size: 16cm

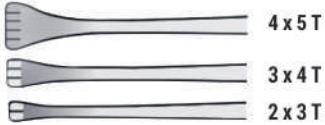
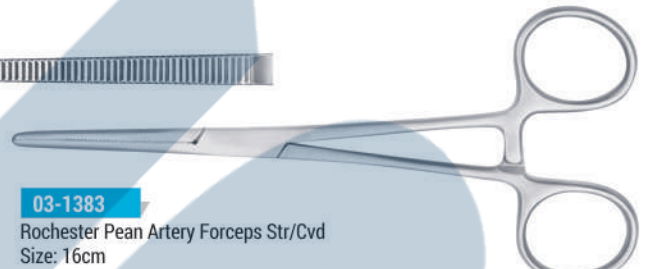

4 x 5 T

3 x 4 T

2 x 3 T

03-1384

Allis Tissue Forceps 2x3T, 3x4T, 4x5T
Size: 15cm

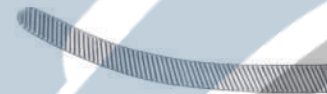
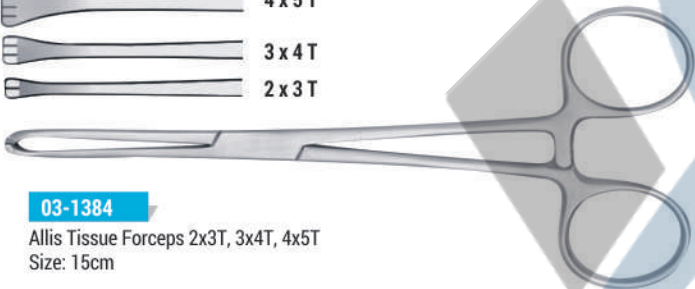

03-1385

Bowel Clamps Doyen Atraumatic
Size: 17cm, 24cm

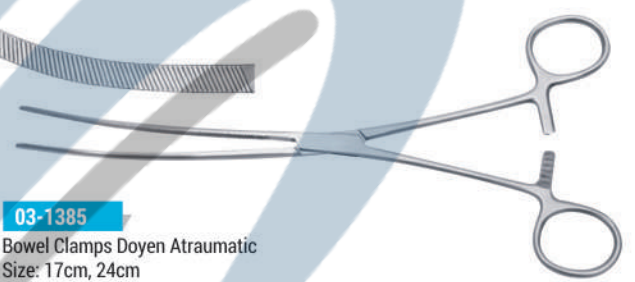

03-1386

Babcock Tissue Forceps
Size: 16cm, 20cm

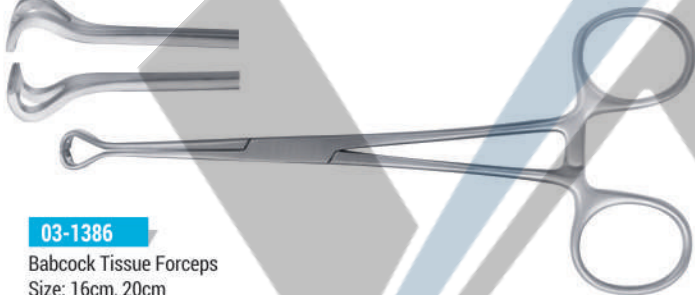

03-1387

Ballenger Sponge Serrated Forceps Str/Cvd
Size: 18cm



03-1388

Baby Mixer Forceps
Size: 14cm, 18cm



Towel Clamps



03-1389

Backhaus Towel Clip
Size: 9cm, 11cm, 13cm



03-1390

Jones Towel Clip
Size: 9cm



03-1391

Lorna Towel Clip
Size: 10cm, 14cm



HAGGAI

SURGICAL

Dressing and Tissue Forceps

03-1392

- (a) Adson Serrated Forceps Size: 12.5cm
- (b) Adson Brown Dissecting Forceps Size: 12.5cm
- (c) Adson Dissecting Forceps 1/2 Teeth Size: 12.5cm



03-1393

Lanes Dissecting Forceps 1/2 Teeth
Size: 15cm



03-1394

Surgical Dressing Forceps
Sizes: 13cm, 14cm, 16cm, 18cm, 20cm, 25cm, 30cm



03-1395

Standard Tissue Forceps 1/2 Teeth
Sizes: 13cm, 14cm, 16cm, 18cm, 20cm, 25cm, 30cm

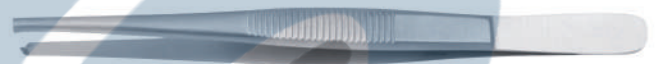

03-1396

Russian Tissue Forceps
Sizes: 16cm, 20cm



Hollowares



03-1397

Kidney Dishes
Sizes: 6", 8", 10" 12"



03-1398

Instrument Steel Boxes Box with Lid
250mm x 120mm x 50mm
300mm x 150mm x 50mm
400mm x 200mm x 70mm



03-1399

Lotion Bowls
200mm x 100mm x 40mm
Sizes: 6", 8", 10"

Scalpel Handles

03-1400

Scalpel Handle No. 3



03-1401

Scalpel Handle No. 4





HAGGAI

SURGICAL

Needle Holders

03-1402
Mayo-Hegar
14cm, 16cm, 18cm, 20cm

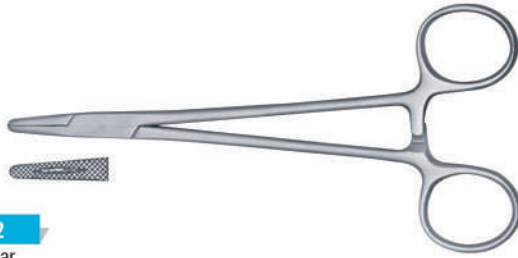

03-1403
Crile-Wood, Size: 15cm



03-1404
Derf, Size: 12cm



03-1405
Ryder, Size: 15cm

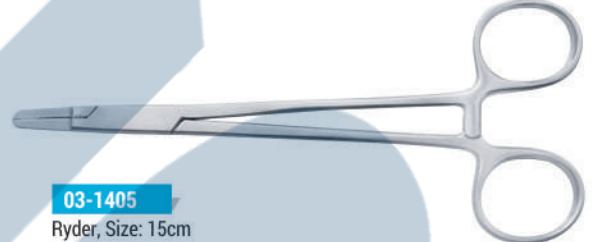

03-1406
Mathieu 14cm, 16cm, 18cm



03-1407
Olsen Hegar 14cm, 17cm, 19cm

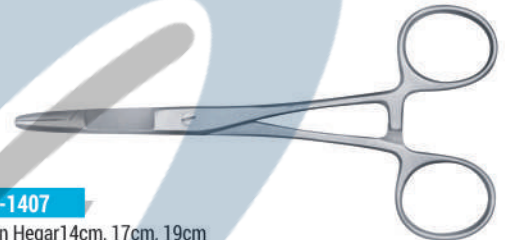

Scissors

03-1408
Mayo Scissor , Str/Cvd
Size: 14cm, 17cm, 21cm



03-1409
Dressing Scissor, Str/Cvd
Size: 13cm, 14cm, 16.5cm, 20.5cm

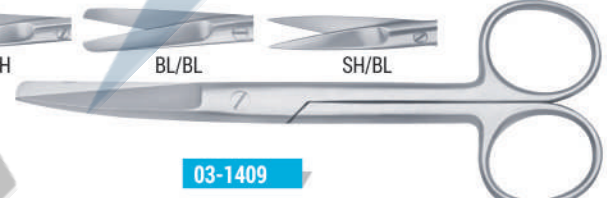

03-1410
Metzenbaum Scissor, Str/Cvd
Size: 12cm, 14cm, 18cm, 20cm



03-1411
Lister Bandage Scissor
Size: 14cm, 16cm, 18cm, 20cm



03-1412
Iris Scissor, Str/Cvd
Size: 11.5cm

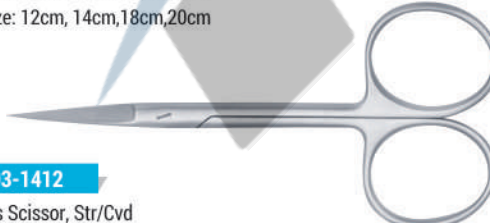

03-1413
Spencer Suture Scissors
Size: 9cm, 13cm



03-1414
Stevens Tenotomy Scissors, Str/Cvd, Size: 11.5cm



03-1415
Umbilical Cord Scissors, Size: 11cm





Retractors

HAGGAI

SURGICAL



03-1416 Balfour Abdominal Retractor

Balfour Abdominal Retractor 180mm Opening
Balfour Baby Abdominal Retractor 90mm Opening

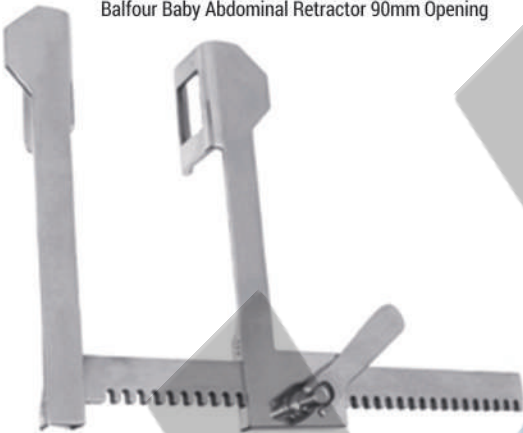

03-1419 Finochietto Rib Retractor

Finochietto Rib Retractor Small 75mm Spread
Finochietto Rib Retractor Large 140mm Spread

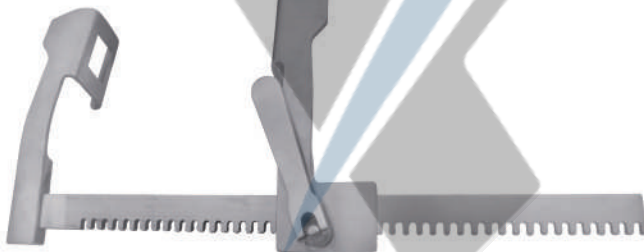

03-1421 Rib spreader Stainless steel

Rib spreader Stainless steel Standard Size,
blades 48mm deep x 65mm wide, 12" Spread, Curved arms



03-1423 Morris Single Ended Retractors

Morris Single Ended Retractor 5.2x3.8cm
Morris Single Ended Retractor 5.2x5.2cm
Morris Single Ended Retractor 5.2x6.4cm



03-1417 Gelpi Retractors

Mini Gelpi Retractor 90cm Gelpi Retractor 14cm 5.5"
Gelpi Retractor 18cm 7" Weitlaner Retractor 6.5" Sharp Teet

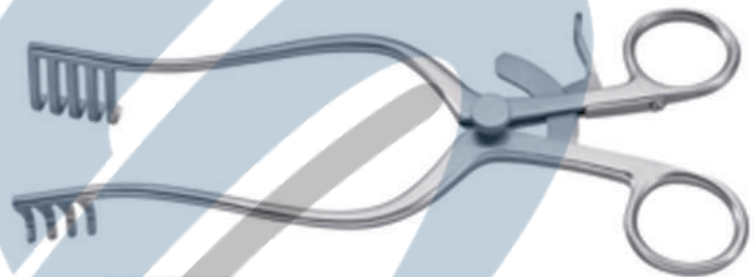

03-1418 Travers Retractor

Travers 4x5 Teeth Retractor 20cm 8"



03-1420 Weitlaner Retractors

Weitlaner Retractor 7" Blunt Teeth Small Weitlaner
Retractor 5.5" Sharp 3x4 Teeth Weitlaner Retractor 6.5" Blunt 3x4 Teeth



03-1422 Senn Miller Retractors

Senn Miller Retractor Blunt Teeth
Senn Miller Retractor Sharp Teeth



03-1424 Langenbeck Retractors

Langenbeck Retractors 2.3x0.7cm
Langenbeck Retractors 4.4x1.3cm
Langenbeck Retractors 6.5x2.5cm
Langenbeck Retractors 9.0x2.0cm



HAGGAI

SURGICAL

Equine Surgical Instruments



03-1425

Cervix Forceps Equine Related Size 21" 53cm Easy to hold pistol handle with step locking ratchet mechanism and easy to release one click hook for ease of operation.



03-1426

Alligator Forceps 14cm 5.5" Serrated



03-1427

Jackson uterine biopsy forceps
Stainless steel biopsy forceps has a 4mm x 28mm cutting area and 60cm long shaft. Popular for equine uterine biopsy



03-1428

Mare Biopsy Punch 26". Mare Uterine Biopsy Punch is an equine reproduction product for uses in artificial insemination in horses. Mare biopsy punch with pistol grip handle and locking nut. (26") Long

Miscellaneous Instruments

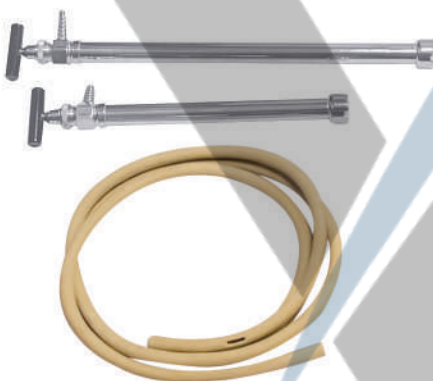

03-1429

Equine Stomach Pump

Size: 15.5 (Small) and 21(Large).
Supplied with 10 feet long tube



03-1430

Mini fibre optic Otoscope with Pouch



03-1431

Mole Trap



03-1432

Digital Thermometer C or F
(Picture for illustration Purposes only)



03-1433

Embryotome Thygesen 85 cm



03-1434

Ear Syringe Complete:
50ml, 75ml, 100ml, 150ml, 200ml



HAGGAI

SURGICAL

Root Elevators



03-1435

Winged Elevators Standard Stubby 1mm-6mm

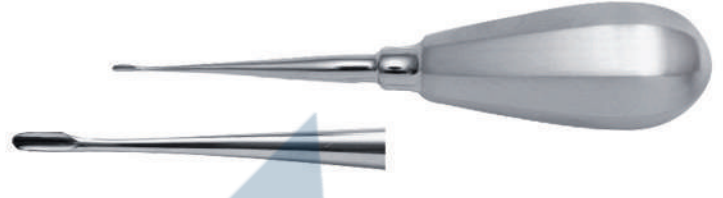

03-1436

Winged Elevators Standard Handle 1mm-6mm



03-1437

Straight Root Tip Elevator Standard Handle



03-1438

Periosteal Elevator Standard Handle

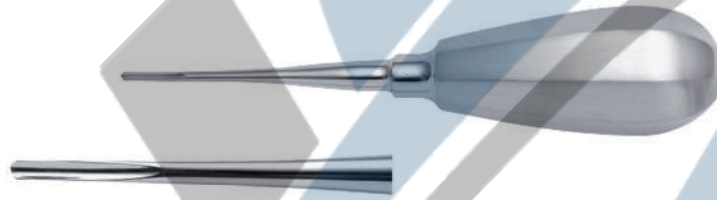

03-1439

Straight Root Tip Stubby Handle Elevators 1mm-2mm(Also Set of 2)



03-1440

Set of Winged Tip Elevators in sizes 1-4mm



03-1441

Set of Winged Tip Elevators in sizes 1-4mm



Root Elevators

03-1442
Canine Root Elevator

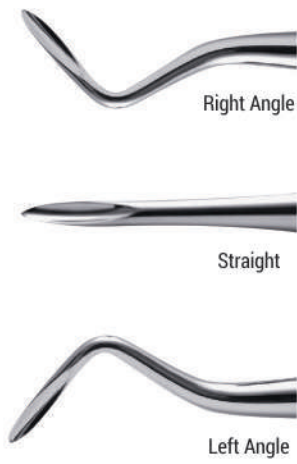

03-1443
Cryer Elevator Set of 2

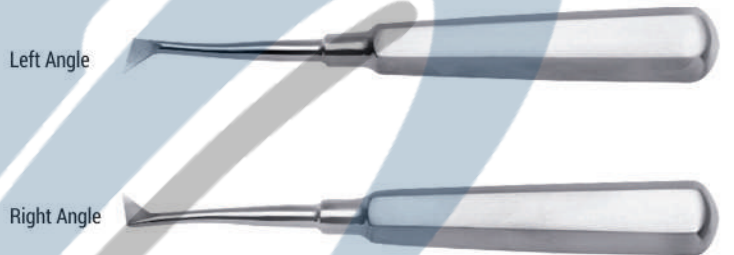

03-1444
Coupland Dental Elevator Set of 1mm-3mm(Set of 3)



03-1445
Elevator Sterilization Tray



03-1446
Elevator Sterilization Tray



Scalers & Probes for Cats & Dogs



03-1447
Explorer/Measuring Probe Standard



03-1448
Periosteal Elevator Double Ended



03-1449
Jaquette Supragingival Scaler Double Ended



03-1450
Subgingival Curette

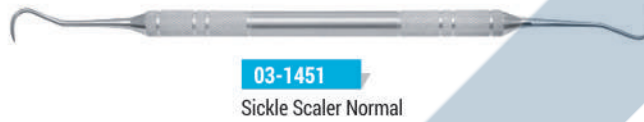

03-1451
Sickle Scaler Normal

Specialized Dog Scalers



03-1452
McCall Dog Scaler, Dual Ended

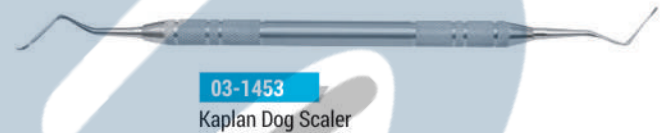

03-1453
Kaplan Dog Scaler



03-1454
Dog Scaler Left



03-1455
Dog Scaler Right



03-1456
Periosteal Elevator No 9



03-1457
Examination Mirror Single Ended used for Small Animal Dentistry

Dental Extraction Forceps & Mouth Retractors



03-1458
Extraction Forceps Angled Jaw, 12 cm



03-1459
Tooth Extraction Forceps, Angled & Straight Jaw, 2.5 cm



03-1460
Small Animal Forceps Fragment, 16.5 cm



03-1461
Root Tip Extraction Forcep, 15 cm



03-1462
Cheek Retractor Minnesota



03-1463
Small Animal Mouth Gag Openers (Set of 5 Gags)

- Mouth Gag for Dog 16 cm
- Mouth Gag for Dog 12.7 cm
- Cat/Dog 8.8cm
- Cat/Dog 5.5 cm
- Special Cat 2.7 cm

VETERINARY CATALOGUE INSTRUMENTS



HAGGAI
SURGICAL

WEBSITE: WWW.HAGGAISURGICAL.COM

✉ emails: haggaisurgical@gmail.com
haggaisurgicalinternational@gmail.com

📞 whatsapp: +923246042453
+923246042419



SADDAR CANTT DHALAY NEAR CHURCH 51310

SIALKOT PUNJAB PAKISTAN